

Australian Transport Council

National Standard  
for  
Commercial Vessels

PART C  
DESIGN AND CONSTRUCTION

SECTION 6B  
BUOYANCY AND STABILITY AFTER FLOODING

Edition 1

Draft for public comment issued—24 October 2008

Endorsed by the Australian Transport Council— 30 April 2010

First Published — 3 May 2010

Amendment 1: October 2010

Edition 1.1, incorporating Correction Amendment 1,

Published: October 2010

Edition 1.2, incorporating Correction Amendment 2,

Published: August 2011

© Commonwealth of Australia

This work is copyright. Apart from any use as permitted under the Copyright Act 1968, no part may be reproduced by any process without the written permission of the Chief Executive Officer, NMSC.

Published by The National Marine Safety Committee, PO Box R1871 Royal Exchange, NSW 1225. All inquiries are to be addressed to the Chief Executive Officer, NMSC Secretariat.

ISBN 0642-736-669

## FOREWORD

This Subsection of the National Standard for Commercial Vessels (NSCV) was developed following a review of the Uniform Shipping Laws (USL) Code Subsection 5C Construction- Watertight Subdivision of Passenger Vessels, Subsection 5D Construction- Construction- Watertight Subdivision of Class 2 and Class 3 Vessels, and Section 10 Life Saving Appliances (Appendices N and O). In reviewing the USL Code and preparing this Subsection, consideration was given to a number of factors, including:

- a) The National Marine Safety Strategy.
- b) Current vessel designs and construction practices.
- c) Relevant national and international standards.
- d) Provisions no longer used.
- e) Current survey practice, both formal and informal.
- f) Discretionary requirements which rely on Authority approval.
- g) Current technical standards format and style.

This Part of the National Standard for Commercial Vessels must be read in conjunction with Part A — Safety Obligations, Part B — General Requirements, Part C — Design and Construction Section 2—Watertight and Weathertight Integrity, Subsection 6A — Intact stability Requirements and Subsection 6C — Stability Tests and Stability Information.

This Subsection of the NSCV was prepared by the NMSC Secretariat in consultation with a working group comprising representatives from the various State and Territory marine authorities. In addition specialist advice was sought on a number of issues.

This draft Subsection was released for public comment on 24 October 2008, along with a draft Regulatory Impact Statement (RIS). A reference group comprising industry and government reviewed the public comment on Subsection 6B on 15 May 2009 and 18-19 June 2009, with recommendations forwarded to NMSC meeting 09-03.

NMSC approved this subsection on 23 November 2009, with the Office of Regulation Review reporting that the final RIS was satisfactory on the 27 January 2010. The Australian Transport Council (ATC) endorsed the document for publication on 30 April 2010.

Edition 1 was later subject to a correction amendment. Amendment 1 to Clause C4.3 and Tables 6 and C.1 was endorsed by NMSC on 5 October 2010 and published in October 2010.

Edition 1.1 was subject to an additional correction amendment. Amendment 2 to Clauses 4.4.2.1, 4.4.2.2, A4.1 to A4.5, and Table 4 was endorsed by NMSC on 23 August 2011 and published in August 2011

## CONTENTS

FOREWORD	.....	3
CONTENTS	.....	4
CHAPTER 1	PRELIMINARY .....	7
1.1	Scope .....	7
1.2	Application .....	7
1.3	Objective.....	7
1.4	Use of NSCV Part C Subsection 6B .....	9
1.5	Referenced documents .....	8
1.6	Definitions.....	11
CHAPTER 2	BUOYANCY AND STABILITY AFTER FLOODING OUTCOMES AND SOLUTIONS.....	17
2.1	Scope .....	17
	Required outcomes.....	17
2.2	Risk of capsize to be controlled .....	17
2.3	Risk of foundering to be controlled.....	17
2.4	Risk of damage to essential systems to be controlled .....	17
2.5	Risk of excessive angles of heel and/or trim to be controlled .....	17
2.6	Sufficient time to respond to flooding .....	18
2.7	Conditions of loading to be safe .....	18
2.8	Analysis of buoyancy and stability in the flooded condition to be relevant and sufficiently accurate.....	18
	Deemed-to-satisfy solutions.....	18
2.9	Compliance.....	18
	Equivalent solutions .....	18
2.10	Assessment methods .....	18
CHAPTER 3	DETERMINING THE APPLICABLE REQUIREMENTS FOR BUOYANCY AND STABILITY AFTER FLOODING .....	19
3.1	Scope .....	19
3.2	Application .....	19
3.3	Source of deemed-to-satisfy solutions for buoyancy and stability after flooding.....	19
3.4	Flooding risk category .....	19
3.5	Flooding scenarios .....	19
3.6	Forms of residual buoyancy .....	19
CHAPTER 4	MEASURES TO CONTROL CONSEQUENCES OF SWAMPING.....	24
4.1	Scope .....	24

4.2	Application .....	24
4.3	Water not to flood decks or buoyant spaces in normal operation .....	24
4.4	Deemed-to-satisfy solutions for controlling the consequences of swamping .....	24
4.5	Types of buoyancy .....	26
4.6	Verification of compliance .....	26
CHAPTER 5	MEASURES TO CONTROL CONSEQUENCES OF LOCAL FLOODING .....	27
5.1	Scope .....	27
5.2	Application .....	27
5.3	Early warning of flooding .....	27
5.4	Separation of spaces liable to flooding .....	28
5.5	Measures to control the risks of local flooding causing premature capsize .....	29
5.6	Local flooding of enclosed Ro-Ro spaces .....	29
5.7	Slack bilges in landing craft .....	31
CHAPTER 6	ADDITIONAL MEASURES TO CONTROL THE CONSEQUENCES OF GROUNDING .....	32
6.1	Scope .....	32
6.2	Application .....	32
6.3	Additional measures to control the consequences of grounding .....	32
6.4	Double bottoms .....	34
6.5	An arrangement of watertight compartments without a longitudinally continuous double bottom .....	37
6.6	Vulnerable hull appendages .....	37
CHAPTER 7	ADDITIONAL MEASURES TO CONTROL CONSEQUENCES OF COLLISION .....	39
7.1	Scope .....	39
7.2	Application .....	39
7.3	Measures to reduce the consequences of bow collisions .....	39
7.4	Measures to reduce the consequences of side collision .....	44
7.5	Measures to reduce the consequences of raking damage on collared vessels with an inflated collar .....	50
CHAPTER 8	CRITERIA FOR BUOYANCY AND STABILITY AFTER FLOODING .....	51
8.1	Scope .....	51
8.2	Application .....	51
8.3	Requirements for determining the flooded condition for the application of comprehensive criteria .....	51
8.4	Comprehensive stability and buoyancy in the equilibrium flooded condition .....	53

8.5	Comprehensive stability during intermediate stages of flooding.....	60
8.6	Basic flotation criteria .....	62
8.7	Level flotation criteria .....	64
CHAPTER 9	REQUIREMENTS FOR THE EFFECTIVENESS OF WATERTIGHT COMPARTMENTS TO PROVIDE ADDITIONAL BUOYANCY .....	69
9.1	Scope .....	69
9.2	Application .....	69
9.3	Height of watertight integrity.....	69
9.4	Strength.....	69
9.5	Marking.....	69
9.6	Penetrations through watertight boundaries .....	70
9.7	Additional requirements for collision bulkheads.....	80
9.8	Drainage wells in the inner bottom of a double bottom structure.....	80
9.9	Verification of watertight integrity .....	81
CHAPTER 10	REQUIREMENTS FOR THE EFFECTIVENESS OF LOW-DENSITY FLOTATION MATERIALS AND AIR CHAMBERS TO PROVIDE ADDITIONAL BUOYANCY.....	82
10.1	Scope .....	82
10.2	Application .....	82
10.3	Material and structural properties.....	82
10.4	Installation .....	84
10.5	Poured foam.....	86
10.6	Inflated collars .....	86
CHAPTER 11	SUBDIVISION LOAD LINE .....	92
11.1	Application .....	92
11.2	Multiple modes of operation .....	92
11.3	Marking.....	92
ANNEX A	SUMMARY OF HAZARDS.....	93
ANNEX B	FUNCTIONAL ANALYSIS OF REQUIREMENTS FOR BUOYANCY AND STABILITY AFTER FLOODING.....	94
ANNEX C	ADDITIONAL BUOYANCY CALCULATION .....	100
ANNEX D	GUIDANCE ON THE DISTRIBUTION OF ADDITIONAL BUOYANCY TO ACHIEVE LEVEL FLOTATION .....	104
ANNEX E	TEST PROCEDURE FOR LEVEL FLOTATION .....	106
ANNEX F	TESTS FOR LOW-DENSITY FLOTATION MATERIALS .....	110
ANNEX G	WARNING SYMBOLS.....	113
ANNEX H	GUIDELINES FOR PROCEDURES OF TESTING WATERTIGHT BOUNDARIES.....	114
ANNEX J	INFORMATION ON BUOYANCY AND STABILITY AFTER FLOODING – PROPOSED AMENDMENT TO NSCV PART C SUBSECTION 6C. ...	119

## CHAPTER 1 PRELIMINARY

### 1.1 SCOPE

This Subsection specifies minimum requirements for the buoyancy and stability of vessels after flooding.

This Subsection shall be read in conjunction with Part B—General Requirements, Part C Section 2—Watertight and Weathertight Integrity, Part C Section 4—Fire Safety, Part C Subsection 6A—Intact Stability Criteria, and Part C Subsection 6C—Stability Tests and Stability Information.

#### NOTES:

1. Part C Subsection 6C specifies requirements for information to be provided on buoyancy and stability after flooding.
2. Additional requirements for the buoyancy and stability of vessels after flooding may be specified by applicable marine pollution legislation such as MARPOL, and/or the International Load Line Convention.

### 1.2 APPLICATION

This Subsection applies to all vessels other than Special Vessels provided for in NSCV Part F of this standard, unless NSCV Part F specifies otherwise.

### 1.3 OBJECTIVE

The objective of this Subsection is to control the risks of flooding arising from the hazards listed in Annex A by reducing the consequences associated with the entry of water into spaces on a vessel.

#### EXAMPLES

Water entering through a breach of a vessel's hull caused by grounding, collision or contact.

Water entering due to a failure of the structural or watertight integrity of the hull, skin fittings, seawater piping, or mechanical sealing arrangements.

Water on the vehicle deck in an enclosed Ro-Ro space.

Water entering due to swamping.

Water entering due to the use of fire fighting systems.

#### NOTES:

1. Flooding of spaces on a vessel can have a significant negative effect on the vessel's stability characteristics by—
  - increasing the vessel's displacement / reducing the vessel's reserve buoyancy;
  - reducing the vessel's freeboard;
  - causing the vessel to trim excessively;
  - changing the location of the vertical centre of gravity;
  - giving rise to transverse heeling moments that can cause large equilibrium angles of heel and/or capsize; and
  - creating large free surface moments.

2. Hazards that may lead to flooding include collision, grounding, stranding, failure of skin fittings or seawater piping systems, structural failure, failure of fastenings or caulking, damage to the propulsion system (e.g., propeller, bearings and shaft), damage to manoeuvring system (e.g., rudder, bearing and shaft), swamping, heavy seas combined with failure of watertight and/or weathertight closing appliances; and failure of means provided to drain cockpits and/or wells.
3. Consequences that may arise from flooding include: capsize, foundering by progressive flooding, disabling of essential or emergency systems, entrapment of persons, excessive heel and/or trim, and exposure of persons to the risks of evacuation.

## 1.4 REFERENCED DOCUMENTS

The following documents are referenced in this Subsection. Any document referenced should be considered to be the latest revision of the document, including amendments, unless stated otherwise.

### NATIONAL MARINE SAFETY COMMITTEE

#### *National Standard for Commercial Vessels*

##### *Part A—Safety Obligations*

##### *Part B—General Requirements*

##### *Part C—Design and Construction*

###### *Section 1: Arrangement, Accommodation and Personal Safety*

###### *Section 2: Watertight and Weathertight Integrity*

###### *Section 3: Construction*

###### *Section 4: Fire Safety*

###### *Section 5: Engineering*

###### *Subsection 5A—Machinery*

###### *Subsection 5B—Electrical*

###### *Section 6: Stability*

###### *Subsection 6A—Intact Stability Criteria*

###### *Subsection 6C—Stability Tests and Stability Information*

###### *Section 7: Equipment*

###### *Subsection 7A—Safety Equipment*

##### *Part D—Crew Competencies*

##### *Part E—Operational Practices*

##### *Part F—Special Vessels*

### STANDARDS AUSTRALIA

#### *AS1799.1—2009 Small craft—Part 1: General requirements for power boats*

#### *AS2677—Inflatable boats*

### AMERICAN SOCIETY FOR TESTING AND MATERIALS



*ASTM D 471-96: Standard Test Method for Rubber Property—Effect of Liquids.*

#### BRITISH STANDARDS

*BS 5241-2: Rigid polyurethane (PUR) and polyisocyanurate (PIR) foam when dispensed or sprayed on a construction site. Specification for dispensed foam for thermal insulation or buoyancy applications.*

#### INTERNATIONAL ELECTROTECHNICAL COMMITTEE

*IEC60529: Degrees of protection provided by enclosures (IP Code)*

#### INTERNATIONAL ORGANIZATION FOR STANDARDIZATION

*ISO12217 Small Craft—Stability and buoyancy assessment and categorization*

*Part 1: Non-sailing boats of hull length greater than or equal to 6 m*

*Part 3: Boats of hull length less than 6 m*

#### INTERNATIONAL MARITIME ORGANIZATION

*The International Convention for the Safety of Life at Sea (SOLAS), Chapter II-1 Part B*

##### NOTES:

1. The current (2008) text of Chapter II-1 of SOLAS is to be found in the SOLAS Consolidated Edition 2004, as amended by IMO Resolutions MSC.151 (78), MSC.170 (79), MSC.194 (80) and MSC.216 (82).
2. Explanatory notes to the SOLAS Chapter II-1 Subdivision and damage stability regulations that are provided in IMO res. MSC.281(85) should be regarded as an integral part of those regulations .

*Resolution MSC188(79) Performance standards for water level detectors on bulk carriers and single hold cargo ships other than bulk carriers*

*Stockholm Agreement. SOLAS Conference 1995— Resolution 14, “Regional Agreement on Specific Stability Requirements for Ro-Ro Passenger Ships”, adopted on 29 November 1995*

*The International Convention for the Safety of Fishing Vessels 1977 (The Torremolinos Convention) as adopted and amended by the 1993 Torremolinos Protocol*

## **1.5 USE OF NSCV PART C SUBSECTION 6B**

A flowchart is provided as Figure 1 to assist users applying this Subsection. This illustrates the process for determining the applicable requirements for buoyancy and stability after flooding for a particular vessel.

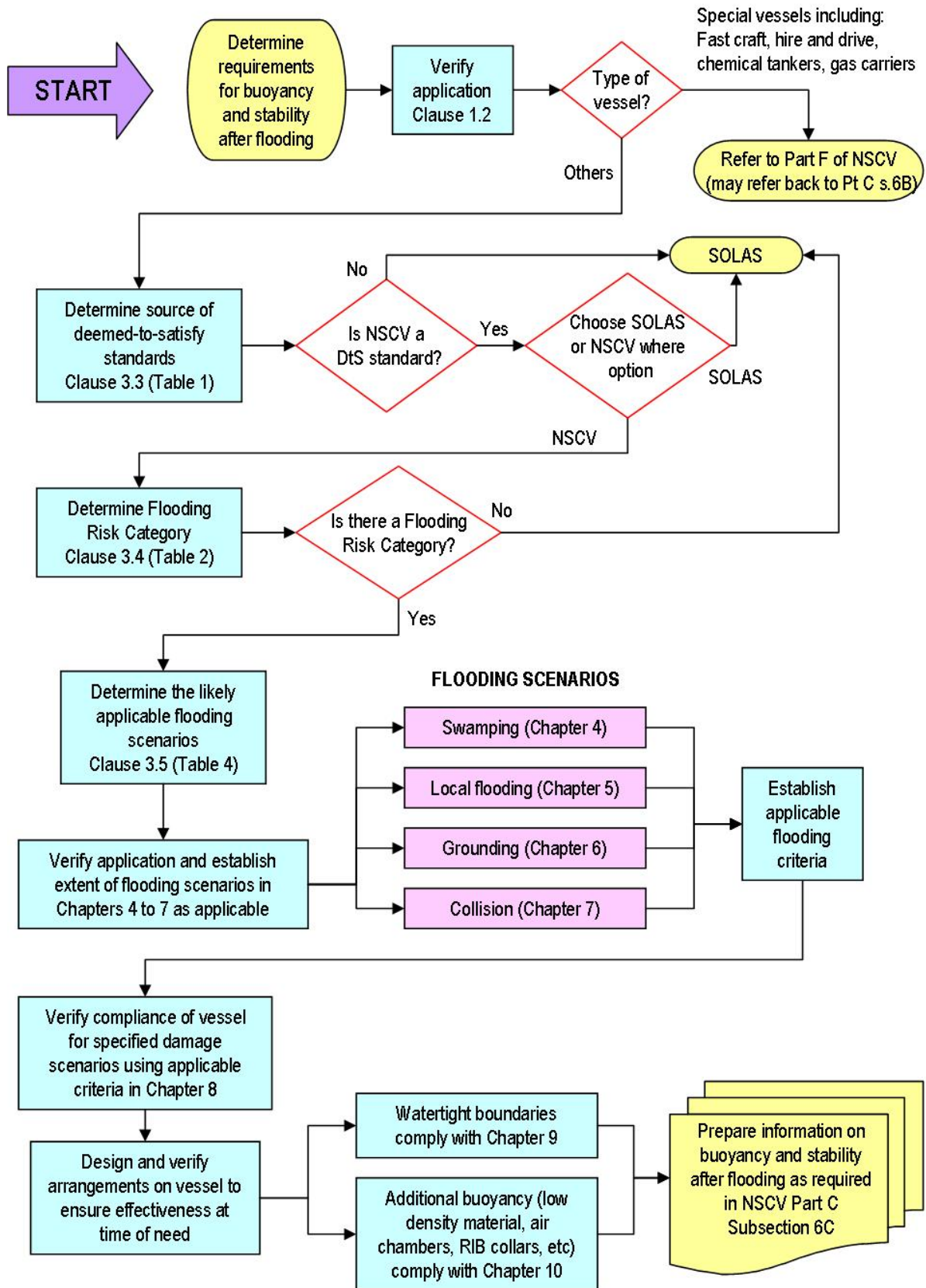

Figure 1 — Flowchart illustrating the use of Subsection 6B

## 1.6 DEFINITIONS

For the purposes of this Subsection —

The definitions provided in this clause shall apply,

- a) the following definitions provided in Part B—General Requirements of the NSCV shall apply: accommodation spaces, breadth, cargo space, Classification Society, crew, depth, domestic operations, fast craft, fish, fishing vessel, hazard, informative, length, maximum speed, may, measured length, must, nautical mile, non-passenger vessel, normative, novel vessel, offshore operations, open vessel, operational area, partially smooth waters, passenger, passenger vessel, restricted offshore operations, risk, safe haven, seagoing, shall, sheltered waters, should, smooth waters, superstructure, unlimited domestic operations, vessel,
- b) required outcome, deemed-to-satisfy solution, equivalent solution, vessel use categories (Class 1, Class 2, etc), operational area categories (Operational Area A, Operational Area B, etc) and service categories (Class 1A, Class 2A, etc) shall have the meanings specified in Part B—General Requirements of the NSCV, and
- c) the following definitions provided in Part C—Design and Construction Subsection 6A—Intact Stability Requirements shall apply: amidships, collared vessel, cockpit vessel, comprehensive stability criteria, deadweight, decked vessel, design waterline, displacement, downflooding angle, free surface, freeboard deck, landing craft, open vessel, righting lever curve, ro-ro vessel, scupper, waterplane, watertight, weather deck, weathertight, and well deck vessel.
- d) where there is any duplication in the terms defined between this Clause and Part B, the definitions in this clause shall apply.

### **actual permeability—**

in relation to a space in a vessel, means the proportion of the immersed volume which, taking account of actual structure and contents of the space, can be occupied by water.

NOTE: Refer to Table 24 Note 1.

### **additional buoyancy—**

buoyancy incorporated into the hull of a vessel to supplement the inherent buoyancy of the vessel, specifically installed so as to achieve compliance with the flooding criteria specified within this Subsection.

NOTE: Additional buoyancy may be provided by low-density flotation material or air chambers.

### **aft terminal—**

is the aft limit of the subdivision length located on the assumed waterline a distance equivalent to the subdivision length ( $L_s$ ) measured abaft the forward terminal.

NOTE: Refer also to definitions for subdivision length and forward terminal.

### **air chamber —**

a buoyant space containing air that is intended to be counted as part of the reserve buoyancy and is either—

- a) made independent of the vessel's structure; or
- b) integral in the vessel structure but is—

- i) too small to allow physical periodic inspection of the interior; and
- ii) is not connected to the bilge system of the vessel.

NOTE: Specific requirements for air chambers are specified in CHAPTER 10.

**assumed permeability—**

in relation to a space in a vessel, means the proportion of the immersed volume that can be occupied by water, assuming that the contents of the space are typical for its nominated purpose.

NOTE: Refer to Table 24.

**basic flotation—**

a flotation system that will keep a vessel carrying its maximum load from sinking when swamped, assuming the occupants of the boat have left it and are in the water clinging to it. With basic flotation the swamped boat may float at any attitude.

**bottom of the hull—**

that portion of the hull of a vessel vulnerable to bottom damage. Taken to be that portion of the hull below a plane located a distance  $B/20$  above the rise of floor, see Figure 2 a), or where the rise of floor is greater than 5 degrees, a transverse line set at 5 degrees from the horizontal, see Figure 2 b).

NOTE: The vessel breadth  $B$  is defined in NSCV Part B.

**bulkhead—**

a vertical watertight boundary.

**bulkhead deck—**

the uppermost deck to which watertight bulkheads and the watertight shell extend. The bulkhead deck may be a stepped deck.

**buoyant space —**

a space the buoyancy of which contributes to the vessel's compliance with the applicable intact stability criteria.

NOTE:

Except for vessels considered open for the purposes of intact stability, openings through boundaries of buoyant spaces are required by NSCV Part C Section 2 to meet specified standards of watertight or weathertight integrity.

**deepest subdivision draft—**

is the draft corresponding to the deepest draft specified by lowest of the waterlines corresponding to—

- a) the summer load line draft from NSCV Part C Section 2;
- b) the maximum scantling draft from NSCV Part C Section 3;
- c) the maximum laden draft compliant with the intact stability criteria specified in NSCV Part C Subsection 6A; and
- d) the maximum laden draft compliant with the buoyancy and stability after flooding criteria in this Subsection.

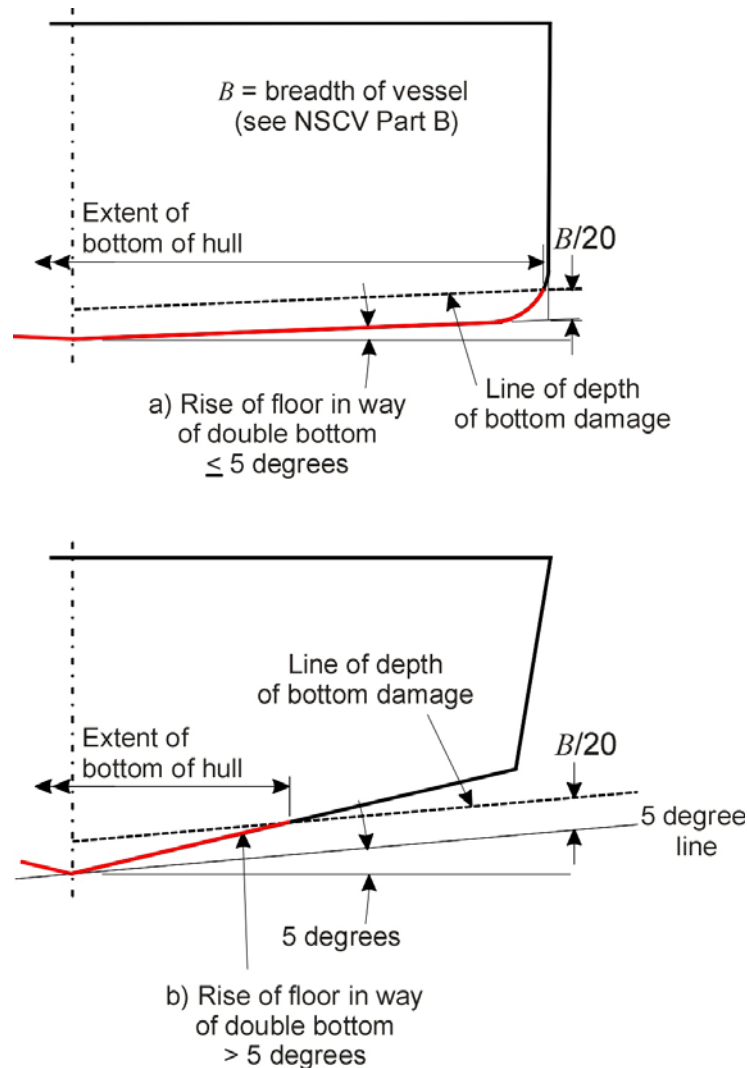

**Figure 2 — Bottom of hull**

**enclosed Ro-Ro spaces—**

spaces not being on a weather deck and intended primarily for carrying motor vehicles or goods that are loaded and unloaded by vehicles operating in a horizontal direction.

**flooding—**

the unintentional entry of sea or fresh water into the buoyant spaces of a vessel by whatever means.

NOTE: Flooding includes swamping, local flooding, grounding and collision.

**forward terminal—**

is the forward limit of the subdivision length ( $L_s$ ) located at the point where the assumed waterline intersects the fore side of the stem.

NOTE: Refer also to definitions for subdivision length and aft terminal.

**hull without appendages—**

for the purposes of this Subsection, the hull of a vessel excluding appendages such as bar keels, solid ballast keels, propellers and propeller brackets, solid skegs and unconnected skegs of flooded volume not more than 2% of maximum displacement.

NOTE: Unconnected skegs are skegs that are fully enclosed by watertight boundaries that prevent the flooding of adjacent spaces.

**level flotation—**

a flotation system that will keep a vessel carrying its maximum load from sinking when swamped, assuming the occupants remain within the boat and supported by the flotation system. The flotation system must be such that it will keep the swamped boat floating level, and prevent it from capsizing in calm water. Level flotation does not provide a self-righting capacity.

**local flooding —**

the unintentional entry of sea or fresh water into a single buoyant space through an unintended opening, hole, crack or gap.

**EXAMPLES**

Failures in seawater or engine exhaust piping or skin fittings

Leaking past caulking on timber vessels

Penetrations through shell plating due to corrosion or cracking

Propeller shaft or rudder stock failures or leakage past seals

Leakage through hatches or other watertight or weathertight closing appliances

Localised damage caused by grounding or collision within a single compartment

**maximum breadth —**

the breadth of the vessel as defined in NSCV Part B.

**one-compartment standard of flooding—**

means that the vessel will comply with the relevant criteria in Chapter 8 assuming that the vessel is subject to—

- a) local flooding of any compartment; and/or
- b) the applicable extent of bottom or side damage; that damage being limited to the space between nominated transverse bulkheads.

**NOTES:**

1. See also two-compartment standard of flooding.
2. Assumes that nominated bulkheads remain undamaged.
3. More than one compartment between nominated bulkheads may be flooded.

**Operational Area B20 —**

offshore operations within a limit of 20 nautical miles to seaward of the coast; or within such lesser limits as may be specified.

NOTE: This operational area aligns with the limit of 20 nautical miles specified in SOLAS that accommodates Flag State variations from the SOLAS provisions. It provides a means of grading between Operational Area B and Operational Area C requirements that allows limited distance lateral operation along the coast using a cut-off that is consistent with both SOLAS and the defined NSCV Operational Areas.

**relative density—**

means the density relative to fresh water at 1000 kg/m<sup>2</sup>.

**residual buoyancy—**

the buoyancy of a vessel after flooding of one or more spaces.

NOTE: Residual buoyancy may be provided by watertight compartments, additional buoyancy or a combination of both.

**rise of floor—**

the height in metres above the lowest point of keel of a point located at the intersection of the line of the bottom shell with the line of the side shell. All the reference points described are for the particular section at the point of consideration.

**subdivision length ( $L_s$ )—**

is 96 per cent of the length in metres of an assumed load waterline drawn parallel to the base line and situated at a height of 85 per cent of the least moulded depth of the vessel. The subdivision length lies between the forward terminal and aft terminal.

In the case of a vessel designed with a rake of keel, the assumed waterline on which  $L_s$  is measured shall be parallel to the designed waterline.

NOTE: Refer also to definitions for forward terminal and aft terminal.

**swamping —**

the unintentional entrapment of sea or fresh water within spaces open to the weather such as found on open vessels, or in the wells or cockpits on vessels.

**EXAMPLES**

Green water coming over the gunwale in heavy seas

A vessel caught by breaking waves while crossing a river bar

Heavy rain

Backflooding onto the deck through scuppers and drains

**two-compartment standard of flooding—**

means that the vessel will comply with the relevant criteria in Chapter 8 assuming that the vessel is subject to the applicable extent of bottom or side damage anywhere within the length required to meet a two-compartment standard.

NOTE: See also one-compartment standard of flooding.

**vulnerable hull appendage —**

an appendage that projects outwards from the hull of a vessel that, if exposed to grounding or other forms of contact, increases the likelihood that the vessel would be vulnerable to flooding; see definition of bottom of the hull and also Figure 5.

**NOTES:**

1. Vulnerable appendages may include high aspect ratio fixed keels, retractable keels, canting keels, propellers and stern frames or rudders that project below the line of keel, sonar domes, retractable thrusters, fin stabilisers and T-foils.
2. Excludes hull appendages that are—
  - a) specifically designed to withstand the effects of grounding or collision such as many skegs; and
  - b) designed to fail without damage to the vessel's watertight integrity.

**watertight boundary —**

internal hull structure that resists progressive flooding and which meets the criteria of CHAPTER 9.

**watertight compartment —**

a buoyant space that is completely bounded by watertight boundaries and the vessel's watertight shell having —

- a) immersed boundaries that, when undamaged, remain effectively watertight over the range of prescribed relevant flooding scenarios;
- b) means of drainage via the vessel's bilge system; and
- c) arrangements to allow physical periodic inspection of the interior.

NOTE: An air chamber is not a watertight compartment for the purposes of this standard.



## CHAPTER 2 BUOYANCY AND STABILITY AFTER FLOODING OUTCOMES AND SOLUTIONS

### 2.1 SCOPE

This Chapter specifies the required outcomes for buoyancy and stability after flooding, and the corresponding requirements for deemed-to-satisfy and equivalent solutions. The required outcomes are mandatory for a particular vessel only to the extent specified by the applicable deemed-to-satisfy solutions within this standard.

NOTE: Annex B lists performance characteristics of prescriptive requirements. These were used to develop the performance requirements contained within this standard.

### REQUIRED OUTCOMES

#### 2.2 RISK OF CAPSIZE TO BE CONTROLLED

A vessel must have arrangements to prevent or control to acceptable levels the likelihood that flooding might result in capsize.

NOTE: The likelihood of capsize after flooding can be significantly increased by the movement of unsecured cargo and other large masses on the vessel.

#### 2.3 RISK OF FOUNDERING TO BE CONTROLLED

A vessel must have arrangements to prevent or control to acceptable levels the risks that flooding might cause the vessel to founder; i.e., sink.

#### 2.4 RISK OF DAMAGE TO ESSENTIAL SYSTEMS TO BE CONTROLLED

A vessel must have arrangements to prevent or control to acceptable levels the risk that immersion by flooding will render inoperative those systems important to the safety of the vessel.

##### EXAMPLE OF HAZARD

Immersion of source of power for bilge pumps.

#### 2.5 RISK OF EXCESSIVE ANGLES OF HEEL AND/OR TRIM TO BE CONTROLLED

A vessel must have arrangements to prevent or control to acceptable levels the risk that excessive angles of heel or trim caused by flooding could render ineffective the operation and use of systems essential to the safety of the vessel.

##### EXAMPLES OF HAZARDS

Heel greater than the maximum allowable angle for operation of emergency machinery

Heel greater than the maximum allowable angle for operation of survival craft launching apparatus.

Deck angles that impede the rapid assembly of persons and their evacuation into the survival craft.

## **2.6 SUFFICIENT TIME TO RESPOND TO FLOODING**

Notwithstanding that a vessel may suffer flooding to an extent that may be beyond that intended for its survival, the vessel must have arrangements that extend the time period available to allow the crew to attempt damage control measures, and to permit persons to escape from enclosed spaces and evacuate the vessel.

### **EXAMPLE**

Even though a vessel may be unable to survive flooding, watertight boundaries on a vessel can significantly extend the time available to reduce the consequences of flooding by allowing the continued operation of important machinery such as bilge pumps, reducing the rate of buoyancy loss, reducing the likelihood of capsize and reducing the rate of listing.

## **2.7 CONDITIONS OF LOADING TO BE SAFE**

The loading of a vessel in normal operation must be kept within the limits necessary to prevent loss, or control to an acceptable level the consequences that would arise, in the event of a flooding incident.

## **2.8 ANALYSIS OF BUOYANCY AND STABILITY IN THE FLOODED CONDITION TO BE RELEVANT AND SUFFICIENTLY ACCURATE**

The Required Outcomes for intact stability in Clauses 2.2 to 2.6 of Part C Subsection 6A apply to the analysis and verification of buoyancy and stability in the flooded condition, where such analysis is required by this Subsection.

## **DEEMED-TO-SATISFY SOLUTIONS**

### **2.9 COMPLIANCE**

For the purpose of this National Standard, the buoyancy and stability after flooding of a vessel shall be deemed-to-satisfy the Required Outcomes in Clauses 2.2 to 2.8 to the extent specified by this Subsection if it complies with the relevant provisions of CHAPTER 3 to CHAPTER 11.

## **EQUIVALENT SOLUTIONS**

### **2.10 ASSESSMENT METHODS**

Assessment methods for equivalent solutions applicable to buoyancy and stability after flooding shall comply with Part B of this Standard. Equivalent solutions applicable to buoyancy and stability after flooding shall be verified in a manner appropriate to the risks that would arise should the buoyancy and stability after flooding be found inadequate.

NOTE: Equivalent solutions that rely on operational controls to maintain effectiveness of the solution or to respond in the event of an incident have frequently been found inadequate in situations that involve flooding emergencies.

## CHAPTER 3 DETERMINING THE APPLICABLE REQUIREMENTS FOR BUOYANCY AND STABILITY AFTER FLOODING

### 3.1 SCOPE

This Chapter specifies the minimum deemed-to-satisfy solutions for buoyancy and stability after flooding applicable to vessels.

### 3.2 APPLICATION

This Chapter applies to all vessels specified in Clause 1.2.

### 3.3 SOURCE OF DEEMED-TO-SATISFY SOLUTIONS FOR BUOYANCY AND STABILITY AFTER FLOODING

A vessel shall be deemed-to-satisfy the requirements of this Subsection if it complies with the standards specified in Table 1.

### 3.4 FLOODING RISK CATEGORY

A vessel that is to be subject to the deemed-to-satisfy provisions contained within this Subsection (denoted by NSCV within Table 1) shall be assigned a Flooding Risk Category (FLRC) in accordance with Table 2.

NOTE: The FLRC is used to grade requirements throughout this standard.

### 3.5 FLOODING SCENARIOS

The minimum requirement for buoyancy and stability after flooding for a particular vessel shall be determined to control the risks of the applicable hazards specified in Table 4.

NOTE: Table 3 provides guidance on the application of flooding hazards to specific types of vessels.

### 3.6 FORMS OF RESIDUAL BUOYANCY

Subject to specified limitations on the use of additional buoyancy, residual buoyancy for compliance with the deemed-to-satisfy requirements specified in CHAPTER 4 to CHAPTER 8 shall be provided by one or a combination of—

- a) watertight compartments complying with CHAPTER 9;
- b) low density flotation material complying with CHAPTER 10; or
- c) air chambers complying with CHAPTER 10.

**Table 1 — Deemed-to-satisfy solutions for buoyancy and stability after flooding**

Operational Area	Class 1 Passenger vessel	Class 2 Non-passenger vessel	Class 3 Fishing vessel
A	SOLAS Chapter II-1 (1)	SOLAS Chapter II-1 if $L_m \geq 35$ m (3)	Torremolinos SFV if $L_m \geq 45$ m (3)
		or NSCV if $L_m < 80$ m	or NSCV if $L_m < 100$ m
B	SOLAS Chapter II-1	SOLAS Chapter II-1 if $L_m \geq 35$ m (3)	Torremolinos SFV if $L_m \geq 45$ m (3)
	or NSCV if $L_m < 60$ m (2)	or NSCV if $L_m < 80$ m	or NSCV if $L_m < 100$ m
B20, C	SOLAS Chapter II-1	SOLAS Chapter II-1 if $L_m \geq 35$ m (3)	Torremolinos SFV if $L_m \geq 45$ m (3)
	or NSCV if $L_m < 80$ m	or NSCV if $L_m < 100$ m	or NSCV if $L_m < 100$ m
D, E	SOLAS Chapter II-1	SOLAS Chapter II-1 if $L_m \geq 35$ m (3)	Torremolinos SFV if $L_m \geq 45$ m (3)
	or NSCV	or NSCV	or NSCV

**KEY:**

NSCV means the deemed-to-satisfy provisions contained within the NSCV apply, see Clauses 3.4 and 3.5.

Lavender shaded areas (mid tone) indicate deemed-to-satisfy for vessels of all lengths.

Dark blue shaded areas (dark) indicate that the application of the NSCV as a deemed-to-satisfy option is limited to vessels of measured length less than that specified.

Light blue shaded areas (white) indicate that the application of the SOLAS or Torremolinos SFV provisions as a deemed-to-satisfy option is limited to vessels of measured length not less than that specified.

- (1) NSCV is not a deemed-to-satisfy option for Class 1A passenger vessels.
- (2) NSCV is not a deemed-to-satisfy option for vessels carrying more than 36 berthed passengers in Operational Area B beyond 20 nautical miles off the coast.
- (3) For Class 2 vessels of length  $< 80$  m and Class 3 vessels  $< 100$  m, the relevant provisions in SOLAS or Torremolinos SFV for bulkheads and double bottoms apply notwithstanding that compliance with damaged stability criteria may not be specified.

Table 2 — Flooding Risk Categories of vessels

Operational area category (see Part B) Vessel use category (see Part B)	Class A Unlimited domestic operations	Class B Offshore operations	Class B20 Offshore operations limited to 20 nm	Class C Restricted offshore operations	Class D Partially smooth waters	Class E Smooth waters
<b>Class 1— Length of vessel</b>		< 60 m (1)	< 80 m (1)	< 80 m (1)	All lengths	All lengths
Class 1: 13 to 36 day passengers	SOLAS Ch. II-1 (2)	III	III	III	III	II
Class 1: 37 to 400 day passengers	SOLAS Ch. II-1 (2)	IV	IV	III	III	III
Class 1: 401 or more day passengers	SOLAS Ch. II-1 (2)	SOLAS Ch. II-1 (2)	IV	IV	III	III
Class 1: 13 to 36 berthed passengers	SOLAS Ch. II-1 (2)	IV	IV	III	III	III
Class 1: 37 or more berthed passengers	SOLAS Ch. II-1 (2)	SOLAS Ch. II-1 (2)	IV	IV	IV	III
<b>Class 2— Length of vessel</b>	< 80 m (1)	< 80 m (1)	< 100 m (1)	< 100 m (1)	All lengths	All lengths
Class 2: Nil passengers	II	II	II	I	I	I
Class 2: 1 to 12 passengers	III	II	II	II	I	I
<b>Class 3— Length of vessel</b>	< 100 m (1)	< 100 m (1)	< 100 m (1)	< 100 m (1)	All lengths	All lengths
Class 3	II	II	II	I	I	I

## KEY:

- (1) No Flooding Risk Category is specified for vessels above the lengths shown as these vessels are required to comply with the relevant SOLAS Chapter II-1 or Torremolinos requirements.
- (2) No Flooding Risk Category is specified for Class 1A vessels, or for Class 1B vessels carrying more than 36 passengers. These vessels are required to comply with the relevant SOLAS Chapter II-1 requirements.

Lavender shaded areas (mid tone) indicate Flooding Risk Category applicable to only vessels below the specified length.

Light green shaded areas (light tone) indicate Flooding Risk Category applicable to vessels of all lengths.

NOTE: Excludes special vessels including fast craft and novel vessels, see Clause 1.2.

**Table 3 — Guidance on application of flooding hazards to vessels**

Description of vessel	Chapter 4 Swamping	Chapter 5 Local flooding	Chapter 6 Grounding	Chapter 7 Bow Collision	Chapter 7 Side Collision	Chapter 7 Raking damage
Measured length less than 6 m	☑	☑	☒	☒	☒	☒
Measured length 6 m to less than 24 m	FLRC II ☑	☑	?	> 12.5m ☑	?	☑
Inflated collar	☑	☑	☒	☑	?	☑
Measured length 24 m to less than 50 m	☒	☑	?	☑	?	☒
Measured length 50 m and more	☒	☑	☑	☑	?	☒
Carrying 36 pax or less	?	☑	?	?	☒	?
Carrying more than 36 pax	?	☑	?	☑	☑	?

## KEY:

☑ means the Chapter applies as part of the deemed-to-satisfy solution, subject to any specific exception that might be contained within the Chapter.

☒ means the Chapter does not apply as part of the deemed-to-satisfy solution.

? means application of Chapter depends on other factors that describe the vessel, refer to the content of the Chapter for more information.

NOTE: More than one type of "Description of Vessel" in column 1 might be required to properly describe a vessel. For example an inflated collar vessel of 12.5 m carrying 40 passengers would apply the 2<sup>nd</sup>, 3<sup>rd</sup> and 7<sup>th</sup> rows.

Table 4 — Application of flooding hazards to vessels

Application		Flooding Risk Category (see Table 2)				Reference
		I	II	III	IV	
<b>Swamping</b>		I	II	III	IV	
Vessels of measured length less than 6 m		☑	☑	☒	☒	Clause 4.2
Open vessels and other vessels of measured length 6 m or more and less than 24 m not having rapid drainage of recesses		☒	☑	☒	☒	Clause 4.2
<b>Local flooding</b>		I	II	III	IV	
Early warning of flooding		☑	☑	☑	☑	Clause 5.3
Separation of spaces liable to local flooding	Machinery spaces 375 kW or more	☑	☑	☑	☑	Clause 5.4
	Machinery spaces 65 kW or more & less than 375 kW	☒	☑	☑	☑	Clause 5.4
	Other spaces liable to local flooding	☒	☒	☑	☑	Clause 5.4
Measures to control the risks of premature capsizing	Arrangements 1 or 2	☑	☑	☑	☑	Clause 5.5
	Arrangement 1, 2 or 3 for vessels of measured length < 15 m	☑	☑	☑	☒	Clause 5.5
	Arrangement 1, 2 or 4 for specified vessels of propulsive power of less than 120 kW	☑	☑	☒	☒	Clause 5.5
Additional provisions for vessels with enclosed Ro-Ro spaces		☑	☑	☑	☑	Clause 5.6
Additional provisions for landing craft		☑	☑	☑	☑	Clause 5.7
<b>Grounding</b>		I	II	III	IV	
Vessels of subdivision length 50 m and more		☑	☑	☑	☑	Clause 6.3
Vessels with vulnerable appendages of draft > 4.0 m		☑	☑	☑	☑	Clause 6.6
<b>Bow collision</b>		I	II	III	IV	
Vessels of measured length > 16 m		☑	☑	☑	☑	Clause 7.3
Vessels of measured length > 12.5 m adopting local flooding option 2 in Clause 5.5 Table 9		☑	☑	☒	☒	Clause 7.3
Additional provisions for vessels with inflated collars		☑	☑	☑	☑	Clause 7.3.7
<b>Side collision</b>		I	II	III	IV	
Vessels carrying more than 36 passengers		N/A	N/A	☑	☑	Clause 7.4
Vessels carrying 13 to 36 passengers		N/A	☒	☒	☑	Clause 7.4
Additional provisions for vessels with inflated collars		☒	☒	☑	☑	Clause 7.4.5
Additional provisions for Class 1A, 1B or 1C vessels with enclosed Ro-Ro spaces carrying more than 36 passengers		☒	☒	☑	☑	Clause 7.4.6
<b>Raking damage</b>		I	II	III	IV	
Vessels with inflated collars		☑	☑	☑	☑	Clause 7.5

KEY:

☑ means required to be deemed-to-satisfy

☒ means not required to be deemed-to-satisfy

N/A means Not Applicable to this Flooding Risk Category.

A2

## CHAPTER 4 MEASURES TO CONTROL CONSEQUENCES OF SWAMPING

### 4.1 SCOPE

This Chapter specifies the deemed-to-satisfy solutions to control the consequences of swamping resulting in large quantities of water lying in recesses or finding its way to spaces below deck.

### 4.2 APPLICATION

#### 4.2.1 Vessels considered at risk of swamping

Except for vessels specified in Clause 4.2.2, this Chapter applies to—

- a) vessels of measured length less than 6 m; and
- b) vessels of Flooding Risk Category II of measured length 6 m or more and less than 24 m.

NOTE: For the deemed-to-satisfy solution, the risks of swamping of vessels of FLRC III and IV over 6 m in length are assumed to be controlled by the combination of watertight and weathertight integrity requirements of Part C Section 2 and the intact stability criteria of Part C Subsection 6A.

#### 4.2.2 Exclusions

The provisions of this Chapter need not apply to vessels that have buoyancy spaces in the form of watertight compartments protected by decks, closures to openings and rapid drainage compliant with Part C Section 2.

NOTE: Such vessels shall be deemed-to-satisfy the requirements of this Chapter.

### 4.3 WATER NOT TO FLOOD DECKS OR BUOYANT SPACES IN NORMAL OPERATION

The vessel shall be arranged to prevent swamping of decks and buoyant spaces over the range of normal operating conditions.

NOTE: This is necessary as the stability criteria for compliance in flooded condition are generally lower than those required for intact stability .

### 4.4 DEEMED-TO-SATISFY SOLUTIONS FOR CONTROLLING THE CONSEQUENCES OF SWAMPING

#### 4.4.1 General requirements

The deemed-to-satisfy solutions for measures to control the consequences of swamping for vessels are specified in Table 5. Water shall be assumed to have flooded all spaces below decks that do not comply with the requirements for decks that are watertight or closures to openings in Part C Section 2. Water of quantity determined in accordance with Clause 4.4.2 shall be assumed to be lying on all decks that do not comply with requirements for rapid drainage in Part C Section 2. The criteria for compliance shall be as specified in the applicable clause in Table 5.



**Table 5 — Deemed-to-satisfy solutions for swamping**

Flooding Risk Category	Buoyancy standard	
	Seagoing	Sheltered water
I	Level flotation in accordance with Clause 8.7 Drainage as per Clause 4.4.3	Basic flotation in accordance with Clause 8.6
II	Level flotation in accordance with Clause 8.7 Drainage as per Clause 4.4.3	Level flotation in accordance with Clause 8.7

NOTE: There is no deemed-to-satisfy solution for vessels of Flooding Risk Categories III or IV as these vessels are assumed to be decked with freeboard, drainage and closing appliances complying with Part C Section 2.

#### 4.4.2 Water in recesses

##### 4.4.2.1 Application

This clause applies to recesses having a recess to reserve buoyancy ratio (*RBR*) exceeding 0.01 where—

$$A2 \quad RBR = \frac{\sum_1^n 0.5 l_{Rn}^2 b_{Rn}^4 d_{Rn}}{L_m^2 B^4 F_{Rb}}$$

where

*RBR* = recess to reserve buoyancy ratio

*l<sub>Rn</sub>* = mean length of recess *n*, in metres

*b<sub>Rn</sub>* = mean width of recess *n*, in metres

*d<sub>Rn</sub>* = mean depth of recess *n*, in metres

*L<sub>m</sub>* = measured length of the vessel, in metres

*B* = maximum breadth of the vessel, in metres

A2 *F<sub>Rb</sub>* = least freeboard over the midships one third measured length in the fully loaded condition, in metres.

##### 4.4.2.2 Assumed quantity of water in recesses

The quantity of water that fills a recess from swamping for the purposes of verifying compliance with the criteria of this Chapter shall be determined as follows—

$$A2 \quad \% \text{ full} = 60 - \left( \frac{240 F_{Rn}}{L_m} \right)$$

where

*% full* = percentage of total water capacity of recess *n*

*F<sub>Rn</sub>* = minimum freeboard to top of recess *n* in the fully loaded condition, in metres

*L<sub>m</sub>* = measured length of the vessel, in metres.

#### **4.4.3 Drainage**

Vessels fitted with a well deck located less than 150 mm above the full laden waterline shall, where specified in Table 5, be provided with arrangements to enable a single person to drain overboard all water in the well in not more than 3 min., assuming the quantity of water as determined in Clause 4.4.2.2 lies within the recess.

Note: This does not apply to cockpit vessels.

#### **4.5 TYPES OF BUOYANCY**

Buoyancy to reduce the consequences of swamping may be in one or more of the following forms:

- a) A volume enclosed by watertight boundaries. The watertight deck may be pierced by watertight or weathertight closing appliances complying with Part C Section 2.

NOTE: The requirements for closing appliances are dependent on the effectiveness of measures to drain wells or cockpits.

- b) Fixed buoyancy material complying with CHAPTER 10.
- c) Air chambers complying with CHAPTER 10.

#### **4.6 VERIFICATION OF COMPLIANCE**

Compliance with the specified criteria shall be verified either by analytical methods specified in Annex C, detailed comprehensive calculation methods or practical testing in accordance with Annex E.

## CHAPTER 5 MEASURES TO CONTROL CONSEQUENCES OF LOCAL FLOODING

### 5.1 SCOPE

This Chapter specifies the deemed-to-satisfy solutions to control the consequences of local flooding of buoyant spaces on the vessel.

NOTE: Sources of local flooding include sea water systems, skin fittings, holes in the shell due to corrosion, rot or leaking caulking, shaft seals, shaft failures, leakage through closing appliances, and structural failures.

### 5.2 APPLICATION

The provisions of this section shall apply to vessels as specified in CHAPTER 3. Each vessel shall apply the Clauses specified in Table 6 to the extent specified within each clause.

**Table 6 — Application of CHAPTER 3**

Vessel type	Clause title	Clause
All types	Early warning of flooding	5.3
All types	Separation of spaces liable to flooding	5.4
All types	Measures to control the risks of local flooding causing premature capsize	5.5
Ro-Ro vessels	Local flooding of enclosed Ro-Ro spaces	5.6
Landing craft	Slack bilges in landing craft	5.7

### 5.3 EARLY WARNING OF FLOODING

A flooding detection system for watertight spaces below the bulkhead deck shall be provided in accordance with Table 7. Where flooding detectors are required, the flooding detection system shall comply with the following:

- a) Flooding detectors shall be located above the lowest part of the compartment, or at the aft end of the compartment where the bottom of the compartment is parallel to the designed waterline.
- b) On vessels of Flooding Risk Category IV or measured length 35 m or more, dual detectors shall be fitted in each applicable compartment and the flooding detection system shall comply with Resolutions MSC188(79) and MSC216(82) Regulation 25.
- c) On vessels of Flooding Risk Category I, II or III and measured length less than 35 m, only a single detector need be fitted in each applicable compartment. The flooding detection system shall be provided with an audible alarm at a continuously manned control position that can be heard with the machinery operating under full power conditions. Where more than one compartment is monitored by a flooding detection system, then a visual alarm indication shall also be provided to enable rapid location of the source of the alarm.

**Table 7 — Deemed-to-satisfy solutions for flooding detection system for watertight compartments**

Flooding Risk Category			Other compartments below the bulkhead deck
	Propulsion machinery compartments or compartments containing sea water pumping systems	Other compartments liable to flooding (see Clause 5.4)	
I	Required if decked (1)	As specified (2)	Not required
II	Required if decked (1)	As specified (2)	Dry cargo holds (3) (4)
III	Required	Required	Not required (5)
IV	Required	Required	Not required (5)

## KEY:

- (1) Refer to NSCV Part C Subsection 5A Chapter 5.
- (2) May apply to spaces containing overboard engine exhaust discharges or piping for filling or discharging fish cargo tanks, refer to NSCV Part C Subsection 5A Chapter 5.
- (3) Not required on compartments that satisfy a one-compartment standard of protection.
- (4) Includes fish holds containing ice or spray brine (does not apply to brine tanks).
- (5) Note that the vessel already meets one-compartment standard of protection.

**5.4 SEPARATION OF SPACES LIABLE TO FLOODING**

A space containing seawater systems, stern glands, rudder stock penetrations, thrusters, canting or retractable keels shall be separated from other spaces in the vessel by watertight boundaries, where specified by Table 8.

**Table 8 — Separation of spaces liable to flooding**

Flooding Risk Category	Spaces containing through hull penetrations or sea water systems for machinery where the largest power of an individual item of propulsion and/or auxiliary machinery within the space is:		Other spaces containing immersed through hull penetrations
	375 kW or more	Less than 375 kW and 65 kW or more	
I	Applicable (1)(2)	Not required	Not required
II	Applicable (1)(2)	Applicable (1)(2)	Not required
III	Applicable (3)	Applicable (3)	Applicable (3)
IV	Applicable (3)	Applicable (3)	Applicable (3)

## KEY:

- (1) The volume of a watertight compartment liable to flooding shall be the smallest compatible with the proper design and function of the vessel.
- (2) Does not apply to vessels of length < 15 m that comply with the basic or level flotation requirements in Clause 5.5.
- (3) Achieved in any case on vessels required to meet a one- or two-compartment standard, see Clause 5.5.

NOTE: NSCV Part C Section 4 specifies requirements for smoke-tight separation of certain machinery spaces depending upon fire risk. Watertight boundaries often also serve to satisfy these requirements.

## **5.5 MEASURES TO CONTROL THE RISKS OF LOCAL FLOODING CAUSING PREMATURE CAPSIZE**

### **5.5.1 Performance requirement**

The vessel shall be arranged so that, in the event of local flooding into a single space; either—

- a) the vessel will not capsize nor founder; or
- b) the likelihood of capsizing or foundering will be considerably reduced or its occurrence significantly delayed.

### **5.5.2 Available deemed-to-satisfy arrangements for compliance**

The vessel shall comply with one of the four arrangements listed in Table 9. Arrangement 3 shall be limited to Flooding Risk Category I, II or III vessels of less than 15 m in measured length. Arrangement 3 with level flotation shall be the only deemed-to-satisfy solution for the following vessels—

- a) Vessels of Flooding Risk Category I or II, that opt under Part C Subsection 7A to have additional buoyancy in lieu of carrying survival craft (life rafts, buoyant apparatus, etc); and
- b) Dinghies of Flooding Risk Category I used as life-saving appliances in Part C Subsection 7A.

Arrangement 4 shall be limited to vessels of Flooding Risk Category I or II with propulsive power less than 120 kW that meet the following criteria—

- i) Multihull vessels shall have reserve buoyancy in the wing hulls sufficient to prevent capsizing when the hull containing the machinery is flooded.
- ii) Catamaran vessels shall have enclosed buoyancy per hull of not less than 150% of the maximum displacement; and
- iii) Monohull vessels shall have a ratio of the quantity of external ballast below the keel to maximum displacement of not less than 15%.

## **5.6 LOCAL FLOODING OF ENCLOSED RO-RO SPACES**

### **5.6.1 Application**

This Clause applies to enclosed Ro-Ro spaces on a vessel, not being a Ro-Ro space with drainage directly overboard that complies with NSCV Part C Section 2.

NOTE: See also Clause 7.4.6.

### **5.6.2 Reducing the likelihood and consequences of local flooding**

A vessel having a minimum freeboard to the Ro-Ro deck in the fully laden condition that is less than the value specified in Table 10 shall comply with the requirements for an inner bow door and protection of openings to spaces below the vehicle deck to the extent specified in Table 10.

**Table 9 — Deemed-to-satisfy solutions to control risks of local flooding causing premature capsizes**

	<b>Arrangement 1 (4)</b>	<b>Arrangement 2 (4)</b>	<b>Arrangement 3</b>	<b>Arrangement 4 (4)</b>
<b>Flooding Risk Category</b>	<b>Minimum number of watertight transverse bulkheads, excluding the collision bulkhead (1)</b>	<b>Maximum spacing between transverse watertight bulkheads including the collision bulkhead if fitted (1)</b>	<b>Additional buoyancy for vessels of measured length &lt; 15 m</b>	<b>Specified vessels of propulsive power of less than 120 kW (see text of Clause 5.5.2)</b>
I	Not less than 2 bulkheads (2)	Adjacent watertight transverse bulkheads spaced not more than 55% of the measured length apart	Sufficient additional buoyancy to comply with the basic flotation criteria in Clause 8.6 (Level flotation criteria in Clause 8.7 if (4) applies)	Transverse bulkheads not required, other than a collision bulkhead as per Clause 7.3.7 on vessels of measured length 12.5 m or more
II	Not less than 3 bulkheads (2)	Adjacent watertight transverse bulkheads spaced not more than 45% of the measured length apart	Sufficient additional buoyancy to comply with the level flotation criteria in Clause 8.7	Transverse bulkheads not required, other than a collision bulkhead as per Clause 7.3.7 on vessels of measured length 12.5 m or more
III (4)	Sufficient watertight bulkheads for a one-compartment standard of protection that complies with the criteria in Clauses 8.4 and 8.5 (3)	Sufficient watertight bulkheads for a one-compartment standard of protection that complies with the criteria in Clause 8.4 and 8.5 (3)	Sufficient additional buoyancy to comply with the criteria in Clauses 8.4 and 8.5 (3)	No alternative available
IV (4)	Sufficient watertight boundaries for a one-compartment standard of protection that complies with the criteria in Clauses 8.4 and 8.5 (3)	Sufficient watertight boundaries for a one-compartment standard of protection that complies with the criteria in Clauses 8.4 and 8.5 (3)	No alternative available	No alternative available

**KEY:**

- (1) Additional transverse bulkheads may be required to satisfy structural requirements in NSCV Part C Section 3, fire safety requirements in NSCV Part C Section 4, Clauses 5.4 and 5.7, and also CHAPTER 6 and CHAPTER 7 where applicable.
- (2) Per hull on multihulls, except where it can be shown that flooding of an offset hull with a lesser number of divisions on vessels of three hulls or more will not cause the vessel to founder or capsize.
- (3) For the purposes of this Clause, the criteria are applied with the space free flooding but without taking into account any specified extent of damage. Compliance with these criteria can be assumed for compartments required to comply with either of the extent of bottom or side damage criteria specified in CHAPTER 6 or CHAPTER 7 respectively.
- (4) Arrangement 3 with level flotation is the only deemed-to-satisfy solution for—
  - a) vessels of Flooding Risk Category I or II, that opt under NSCV Part C Subsection 7A not to carry survival craft (life rafts, buoyant apparatus, etc); and
  - b) dinghies of Flooding Risk Category I used as lifesaving appliances in NSCV Part C Subsection 7A.

**Table 10 — Measures to reduce the likelihood and consequences of local flooding onto an enclosed Ro-Ro deck**

Operational area	Minimum freeboard to the enclosed Ro-Ro deck in the undamaged fully laden condition (m)	Requirement for inner bow door on vessels provided with a bow door	Provision for weathertight integrity of openings to spaces below the vehicle deck
A or B	4.5	Relevant provisions of SOLAS Chapter II-1 for inner bow doors	Relevant provisions of SOLAS Chapter II-1 for weathertight integrity of openings
C	2.5	Relevant provisions of SOLAS Chapter II-1 for inner bow doors	Coamings, sills and closures as per exposed decks in NSCV Part C Section 2
D	1.5	Not required	Coamings, sills and closures as per exposed decks in NSCV Part C Section 2
E	0.5	Not required	Coamings, sills and closures as per exposed decks in NSCV Part C Section 2

**5.7 SLACK BILGES IN LANDING CRAFT**

This Clause applies to landing craft having a flat bottom or small rise of floor. The intermediate stages of flooding of each single compartment below the vehicle deck that extends transversely more than 40% of the vessel's maximum breadth shall be analysed for compliance with the relevant criteria in Clause 8.5.

NOTE: Landing craft need special consideration because of the combination of large beam and shallow draft, large free surface and, in some cases, unsecured deck cargo.

## CHAPTER 6 ADDITIONAL MEASURES TO CONTROL THE CONSEQUENCES OF GROUNDING

### 6.1 SCOPE

This Chapter specifies deemed-to-satisfy solutions to control the consequences of grounding that are additional to the protection given by the measures specified in CHAPTER 5.

NOTE: Grounding includes unintentional contact with the sea bed, intentional beaching and tidal grounding.

### 6.2 APPLICATION

Unless otherwise specified, the provisions of this Chapter shall apply to those vessels specified in CHAPTER 3 and Table 11.

Vessels that are permanently moored need not comply with the provisions of this Chapter.

NOTE: It is assumed that the likelihood and/or consequences of damage from grounding will be significantly reduced on a vessel that is permanently moored.

A double-ended vessel intended for navigation in either direction shall comply at each end with the requirements for additional protection at the forward portion of the vessel contained in this Chapter.

**Table 11 — Additional measures to control the consequences of grounding**

Application	Relevant Clause
Vessels of subdivision length 50 m and more	Clause 6.3
Vulnerable hull appendages that project 4 m or greater below the waterline at the deepest subdivision draft	Clause 6.6

### 6.3 ADDITIONAL MEASURES TO CONTROL THE CONSEQUENCES OF GROUNDING

#### 6.3.1 Extent and standard of protection

Vessels of subdivision length of 50 m or more shall be arranged in accordance with Table 12 so that, in the event of the vessel being holed by grounding the chance of foundering will be considerably reduced or its occurrence significantly delayed.

#### 6.3.2 Nature of protection

The protection specified in Table 12 shall be provided by—

- a double bottom complying with Clause 6.4, see Figure 3a);
- an arrangement of watertight compartments formed by watertight bulkheads and decks, Clause 6.5, see Figure 3b); or
- a combination of both these measures, Clause 6.5, see Figure 3c).



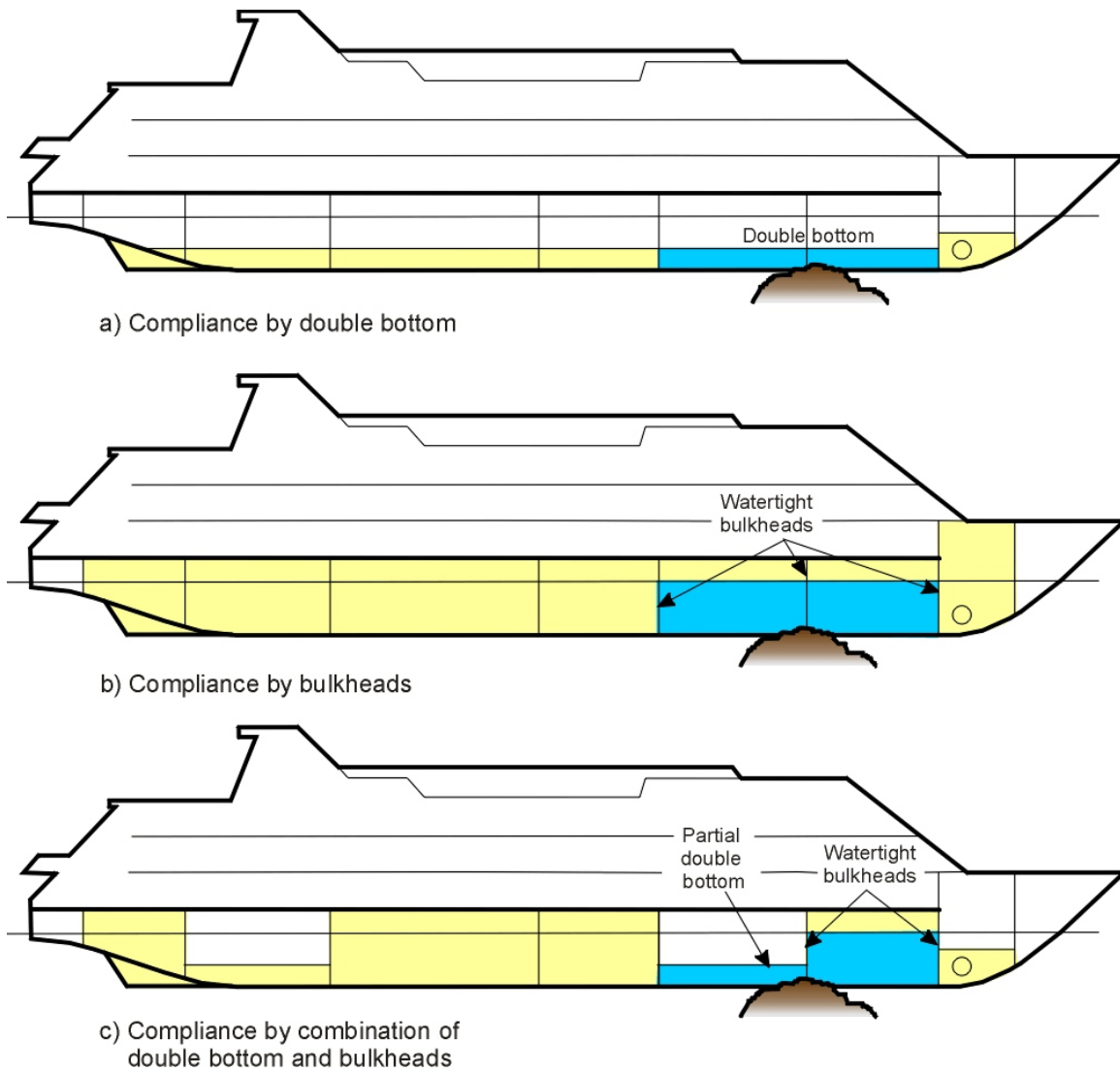

**Figure 3 — Options for control of bottom damage**

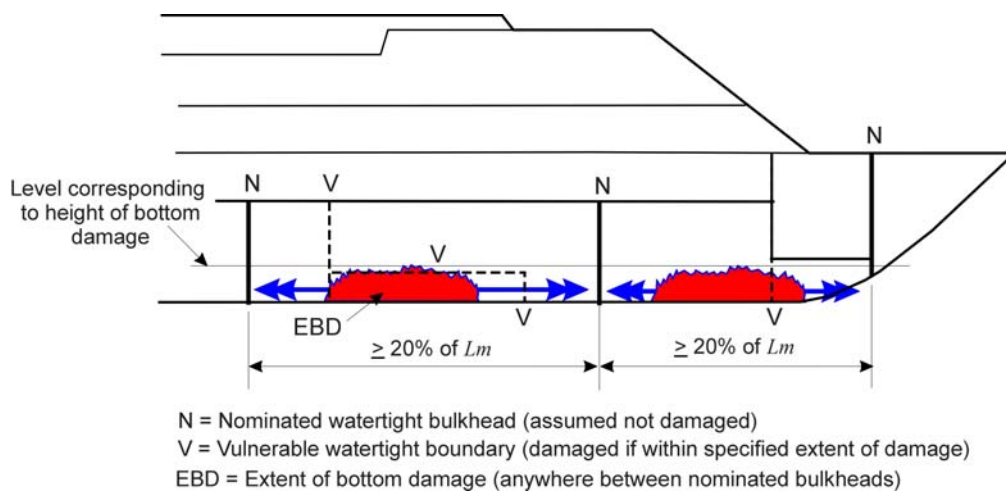

**Figure 4 — Illustration of one-compartment standard (20% min.)**

**Table 12 — Additional measures to control the consequences of grounding**

Flooding risk category	Forward portion of vessel to forward engine room bulkhead or 55% of $L_s$ , whichever is further aft	Remainder of vessel
I	Double bottom or or one-compartment standard (20% min.), see Clause 6.5.2 and (1)	No requirement
II	Double bottom or one-compartment standard (20% min.), see Clause 6.5.2 and (1)	Double bottom or one-compartment standard (20% min.), see Clause 6.5.2 and (1)
III	Double bottom or two-compartment standard, see Clause 6.5.2	Double bottom or one-compartment standard (20% min.), see Clause 6.5.2 and (1)
IV	Double bottom or two-compartment standard, see Clause 6.5.2	Double bottom or two-compartment standard, see Clause 6.5.2

**KEY:**

- (1) One-compartment standard (20% min.) means that bulkheads lying between any nominated pairs of bulkheads spaced not less than 20% of  $L_m$  apart shall be analysed for damage to the assumed length of damage, but the nominated bulkheads themselves need not be considered damaged for the purposes of verifying compliance, see Figure 4.

**6.4 DOUBLE BOTTOMS****6.4.1 Calculation of compliance with CHAPTER 8 not required**

A double bottom shall be deemed to satisfy the minimum standard of protection requirements of Table 12 without requiring supporting calculations provided the double bottom extends over the required extent of protection and complies with—

- a) the provisions of this Clause; and
- b) the relevant provisions applicable to watertight boundaries specified in CHAPTER 9.

**6.4.2 Location of inner bottom**

The inner bottom of a double bottom shall be located in accordance with Table 13.

**Table 13 — Deemed-to-satisfy requirements for the height of the inner bottom of a double bottom**

Characteristic	Requirement
Minimum height over the length of the double bottom above the keel at the centre line of the hull	Not less than the greater of— $\frac{B_{dsd}}{20} \text{ m or } 0.76 \text{ m}$ where $B_{dsd}$ = for monohull vessels, the greatest moulded breadth of the vessel at or below the deepest subdivision draft, in m. = for multihull vessels, the greater value of either— a) half the moulded breadth at or below the deepest subdivision draft; or b) the sum of the greatest moulded breadth of each hull at or below the deepest subdivision draft, in m.
Minimum height over the length of the double bottom above the lesser of— a) the rise of floor; or b) a line inclined at 5 degrees to the horizontal plane (see Figure 2)	Not less than— $\frac{B_{dsd}}{20} \text{ m}$ where $B_{dsd}$ = for monohull vessels, the greatest moulded breadth of the vessel at or below the deepest subdivision draft, in m. = for multihull vessels, the greater value of either— a) half the moulded breadth at or below the deepest subdivision draft; or b) the sum of the greatest moulded breadth of each hull at or below the deepest subdivision draft, in m.
Maximum height above the keel at centre line of the hull at any point of the double bottom (1)	Not greater than the lesser of— $\frac{D}{4} \text{ m or } 2 \text{ m}$ where $D$ = The moulded depth of the vessel, in m.

**KEY:**

(1) Double bottom structures of height exceeding this value may still be considered, but as flooded compartments as per Clause 6.5.

**Table 14 — Deemed-to-satisfy requirements for the extent of bottom damage**

Requirement for bottom damage	Method of application see Table 13	
	One-compartment standard (20% min.) (1)	Two-compartment standard
<p>Longitudinal extent (length of hole) not less than the lesser of—</p> $0.33 L_m^{2/3} \text{ m or } 14.5 \text{ m}$ <p>where</p> <p><math>L_m</math> = the measured length of the vessel, in m.</p>	<p>Anywhere on bottom of hull between each adjacent pair of nominated transverse bulkheads (2) spaced not less than 20% of <math>L_m</math> apart.</p>	<p>Anywhere on bottom of hull</p>
<p>Transverse extent (width of hole) not less than the lesser of—</p> $B_{dsd} / 6 \text{ m or } 5 \text{ m}$ <p>where</p> <p><math>B_{dsd}</math> = for monohull vessels, the greatest moulded breadth of the vessel at or below the deepest subdivision draft, in m.</p> <p>= for multihull vessels, the greater value of either—</p> <p>a) half the moulded breadth at or below the deepest subdivision draft; or</p> <p>b) the sum of the greatest moulded breadth of each hull at or below the deepest subdivision draft, in m.</p>	<p>Anywhere on bottom of hull</p>	<p>Anywhere on bottom of hull</p>
<p>Vertical extent from the 5 degree (penetration into the hull) not less than the lesser of—</p> $B_{dsd} / 20 \text{ m or } 2 \text{ m}$ <p>where</p> <p><math>B_{dsd}</math> = for monohull vessels, the greatest moulded breadth of the vessel at or below the deepest subdivision draft, in m.</p> <p>= for multihull vessels, the greater value of either—</p> <p>a) half the moulded breadth at or below the deepest subdivision draft; or</p> <p>b) the sum of the greatest moulded breadth of each hull at or below the deepest subdivision draft, in m.</p>	<p>Anywhere on the bottom of hull</p>	<p>Anywhere on the bottom of hull</p>

**KEY:**

- (1) One-compartment standard (20% min.) means that bulkheads lying between any nominated pairs of bulkheads spaced not less than 20% of  $L_m$  apart are to be analysed for damage to the assumed length of damage, but the nominated bulkheads themselves need not be considered damaged for the purposes of verifying compliance, see Figure 4.
- (2) The term “each adjacent pair of nominated transverse bulkheads” also includes those portions of the hull between the extreme ends of the vessel and the adjacent nominated transverse bulkhead.

## **6.5 AN ARRANGEMENT OF WATERTIGHT COMPARTMENTS WITHOUT A LONGITUDINALLY CONTINUOUS DOUBLE BOTTOM**

### **6.5.1 Requirements for compartment boundaries**

The boundaries of the compartments shall comply with the provisions applicable to watertight boundaries specified in CHAPTER 9.

### **6.5.2 Standard for compliance**

The watertight compartments shall be arranged so that, for the extent and standard of protection specified in Table 12, the vessel will, when subject to the extent of damage specified in Table 14 comply with the criteria specified in Clause 8.4, and where applicable Clause 8.5.

## **6.6 VULNERABLE HULL APPENDAGES**

### **6.6.1 Application**

Vessels having vulnerable hull appendages that project 4 m or more below the waterline at the deepest subdivision draft shall be arranged so that, in the event of damage caused to the hull structure caused by the appendage touching bottom the vessel will not founder

NOTE: Vulnerable hull appendage is defined in Clause 1.6. See also Figure 5.

### **6.6.2 Nature of protection**

The protection specified in Clause 6.6.1 shall be provided by—

- a) enclosing the attachment of the appendage at the hull within a compartment separate from spaces containing machinery and/or equipment important for safety; and
- b) for vessels of Flooding Risk Categories II, III or IV, sizing the compartment containing the point of attachment to satisfy the criteria specified in Clause 8.4 if Flooding Risk Category II or III, or the criteria specified in Clauses 8.4 and 8.5 if Flooding Risk Category IV.

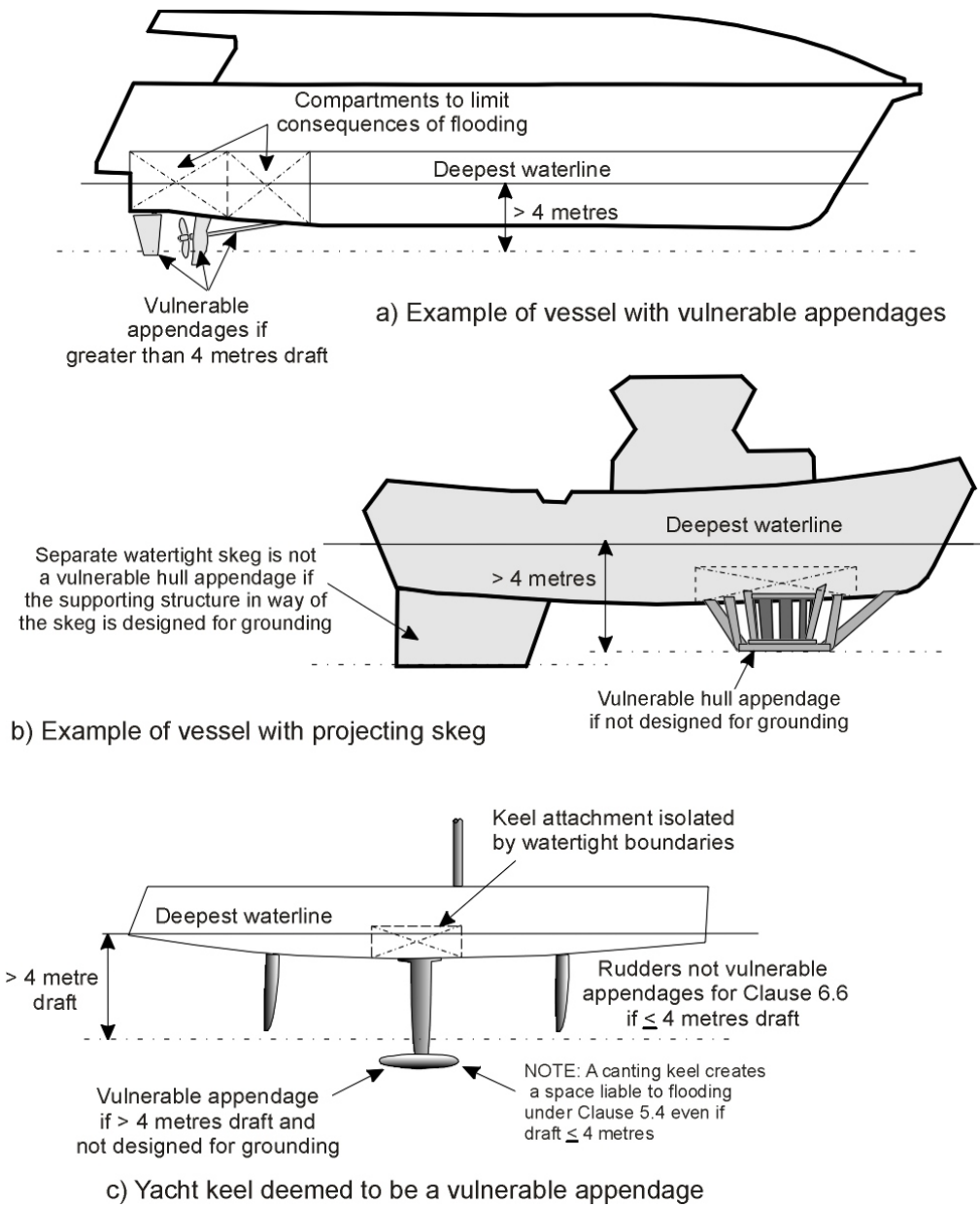

**Figure 5 — Vulnerable appendages**

## CHAPTER 7 ADDITIONAL MEASURES TO CONTROL CONSEQUENCES OF COLLISION

### 7.1 SCOPE

This Chapter specifies deemed-to-satisfy solutions to control the consequences of collision that are additional to the protection given by the measures specified in CHAPTER 5. Three collision scenarios are addressed: bow-on collisions, collisions from the side and, for vessels with an inflated collar, side raking.

### 7.2 APPLICATION

The provisions of this Subsection shall apply to vessels as specified in CHAPTER 3.

### 7.3 MEASURES TO REDUCE THE CONSEQUENCES OF BOW COLLISIONS

NOTE: The majority of serious collisions between vessels involve at least one of the vessels impacting bow-on.

#### 7.3.1 Application

Unless otherwise specified, the following vessels shall be fitted with a collision bulkhead at the bow that complies with the provisions of Clause 7.3:

- a) All vessels of measured length 16 m or more.
- b) Certain vessels of measured length 12.5 m or more as specified in Clause 5.5, Table 9, Arrangement 4.

Vessels that are permanently moored need not comply with the provisions of Clause 7.3.

NOTE: It is assumed that the likelihood and/or consequences of damage from bow collision will be significantly reduced on a vessel that is permanently moored.

A double-ended vessel intended for navigation in either direction that is required by this clause to have a collision bulkhead at the bow, shall be fitted with a collision bulkhead compliant with Clause 7.3 at both ends.

#### 7.3.2 Scantlings

The collision bulkhead shall have scantlings increased above those of ordinary watertight bulkheads as required by the relevant standard specified in NSCV Part C Section 3.

#### 7.3.3 Prohibitions on the use of spaces forward of the collision bulkhead

Spaces forward of the collision bulkhead shall not be used for any of the following purposes:

- a) Spaces used for the accommodation of persons.
- b) Storage of fuel or cargo oil.
- c) Storage of dangerous goods, (refer to NSCV Part C Section 4—Fire safety for definition of dangerous goods).

- d) Spaces containing machinery or equipment important for the safety of the vessel.
- e) Fixed ballast or other solid objects that would increase the likelihood of the collision bulkhead being penetrated in the event of a collision.

**Table 15 — Fore and aft location of the collision bulkhead**

Flooding Risk Category	Vessels having an energy coefficient $C_E$ of >75		Vessels having an energy coefficient $C_E$ of $\leq 75$	
	Determination of forward-most location	Determination of aft-most location (1) (2)	Determination of forward-most location	Determination of aft-most location (1) (2)
I & II	Minimum distance $L_C = 8\% L_S - B_A$	Method 1; or Method 2 with take-home capability if seagoing (3)	Minimum distance $L_C = 5\% L_S - B_A$	Method 1; or Method 2 with take-home capability if seagoing (3)
III	Minimum distance $L_C = 8\% L_S - B_A$	Method 3—includes Method 2 with take-home capability if seagoing (3)	Minimum distance $L_C = 5\% L_S - B_A$	Method 1; or Method 2 with take-home capability if seagoing (3)
IV	Minimum distance $L_C = 8\% L_S - B_A$	Method 3—includes Method 2 with take-home capability if seagoing (3)	Minimum distance $L_C = 5\% L_S - B_A$	Method 3—includes Method 2 with take-home capability if seagoing (3)

**KEY:**

Distance means the distance aft from a point at the intersection of the deepest subdivision draft and the stem (the forward datum).

$L_S$  is the subdivision length, in m

$B_A$  is the bulbous bow allowance on vessels with a bulbous bow, being the lesser of—

- a) half the distance from a point at the intersection of the deepest subdivision draft and the stem to the forward end of the bulbous bow, in m; or
- b)  $1.5\% L_S$ , in m.

(1) Clause 7.3.3 places limitations on the use of compartments forward of the collision bulkhead.

(2) For an explanation of Methods 1, 2 and 3, refer to Table 16 and Figure 6.

(3) For vessels in Operational Areas A, B, B20 and C, assuming that the spaces forward of the collision bulkhead are flooded, the equilibrium trimmed waterline shall satisfy both the following criteria, see Figure 6b):

- (a) The freeboard at any point shall not be reduced more than 75% of the undamaged freeboard at that point.
- (b) The residual propulsive and manoeuvring capability in the damaged condition shall be sufficient to enable the vessel to make a safe haven under its own power.

NOTE: The lower end of a collision bulkhead compliant with the above may intersect the stem at a location above the waterline in one or more conditions of loading. Additional protection can be achieved by locating the lower end of the collision bulkhead abaft the intersection of the stem with the waterline in all conditions of loading.

**7.3.4 Longitudinal location of the collision bulkhead**

The collision bulkhead shall be located to comply with Table 15. The energy coefficient  $C_E$  shall be determined as follows:



$$C_E = \frac{\Delta V_M^2}{L_S^2}$$

where

$C_E$  = the energy coefficient

$\Delta$  = the displacement of the vessel when fully laden, in tonnes

$V_M$  = the maximum speed of the vessel, in knots

$L_S$  = the subdivision length of the vessel, in m.

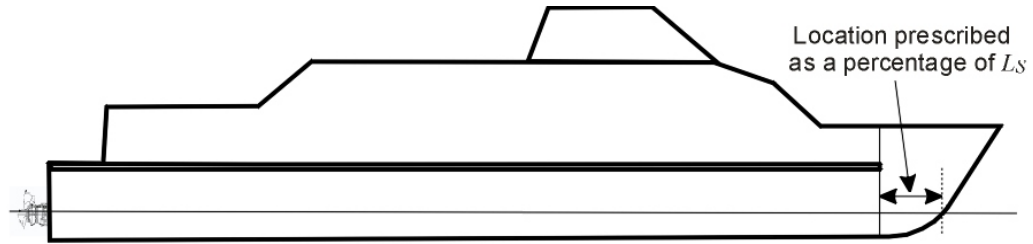

a) Method 1

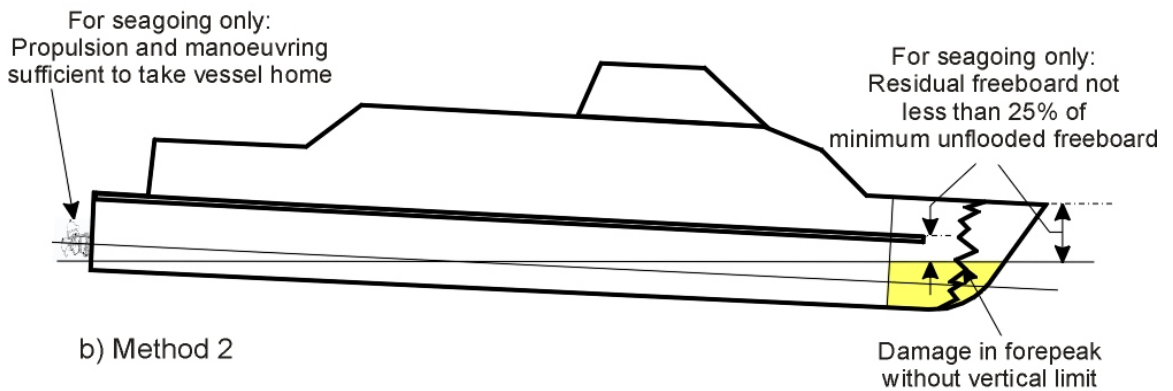

b) Method 2

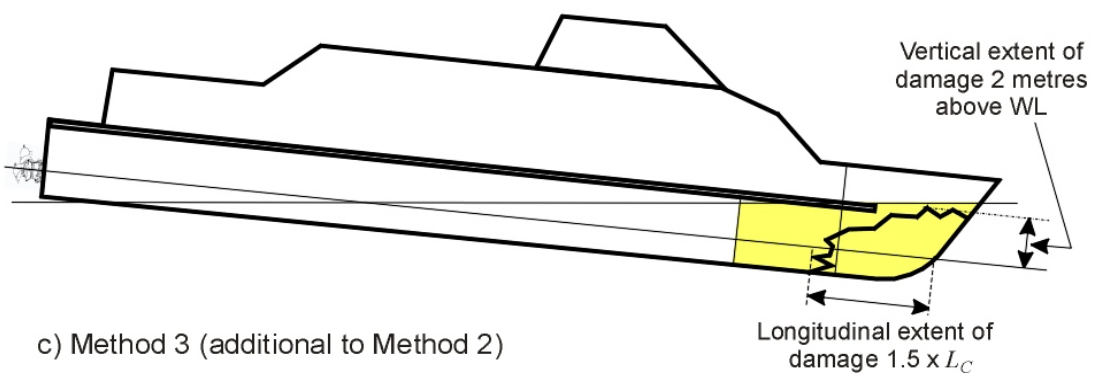

c) Method 3 (additional to Method 2)

**Figure 6 — Methods for establishing the location of the collision bulkhead**

**Table 16 — Collision bulkhead: determination of aft-most location**

Title	Method description
Method 1	The collision bulkhead shall be located from the intersection of the deepest subdivision draft and the stern a distance not more than the lesser of 15% $L_S$ or 5% $L_S + 3$ m, see Figure 6a)
Method 2	The collision bulkhead shall be located sufficiently forward to enable the vessel to meet a one-compartment standard of protection in accordance with Clause 8.4 for the spaces forward of the collision bulkhead assuming vertical damage without limit forward of the collision bulkhead, see Figure 6b)
Method 3	The collision bulkhead shall be located to comply with the criteria in Method 2. In addition where the collision bulkhead lies forward of a plane located less than $1.5L_C$ abaft the forward end of the deepest subdivision draft, the vessel shall satisfy a two-compartment standard in accordance with Clauses 8.4 and 8.5 (1). The vertical extent of damage shall be taken to the lesser height of the underside of the bulkhead deck or 2 m above the waterline at the deepest subdivision draft. (i.e., the spaces forward and abaft the collision bulkhead both assumed flooded, see Figure 6c). Take-home capability is not required for the two-compartment damage scenario.

KEY:

$L_C$  = The forward-most location of the collision bulkhead from Table 15.

(1) Notwithstanding that the collision bulkhead may be located abaft the extent of fore-end collision damage, a two-compartment standard may also apply to the forepeak and the compartment abaft the forepeak if specified for side damage requirements, see Table 4.

### 7.3.5 Vertical height of the collision bulkhead

The collision bulkhead shall be watertight up to the bulkhead deck.

If the vessel has an enclosed superstructure forward above the bulkhead deck of length exceeding a distance 15 per cent of the subdivision length abaft the forward datum, the collision bulkhead shall extend beyond the bulkhead deck and up to the deck next above the bulkhead deck. The extension may form a step at the bulkhead deck forward of the collision bulkhead provided distance between the extension and the forward datum is not less than 5 per cent of the subdivision length of the vessel. The number of penetrations through the extension to the watertight bulkhead and that part of the bulkhead deck that forms a step shall be kept to the minimum practicable. Any such penetrations shall be provided with watertight or weathertight closing appliances. (see Figure 7).

NOTE: The inner bow door substitutes for the extension to the collision bulkhead on Ro-Ro vessels fitted with a bow door,

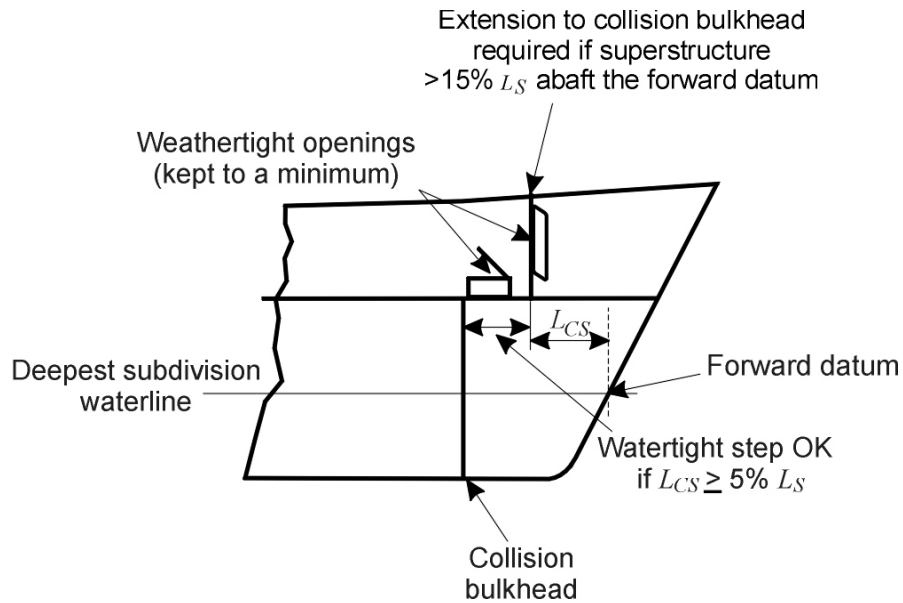

**Figure 7 — Extension to collision bulkhead in way of long superstructure**

**7.3.6 Steps or recesses in collision bulkheads below the level of the bulkhead deck**

Subject to minimum requirements that may apply for side damage specified in Clause 7.4, the collision bulkhead of a vessel may contain a step or recess provided it lies wholly abaft a plane corresponding to the minimum distance specified in Table 15.

The collision bulkhead may be arranged with a step that extends forward of the plane corresponding to the minimum distance specified in Table 15 provided—

- a) the vessel has a measured length of 20 m or less;
- b) the vessel has an energy coefficient  $C_E$  not greater than 75;
- c) the rake of the stem forward from the vertical exceeds  $15^\circ$ ; and
- d) the step complies with the requirements specified in Table 17, see Figure 8.

**Table 17 — Minimum requirements for collision bulkheads that incorporate a step**

Description	Requirement
Lower vertical portion	Not less than 5% $L_S$ abaft the forward datum, see Table 15
Horizontal step	Not less than 2.5% $L_S$ above the waterline corresponding to the deepest subdivision draft
Upper vertical portion	Not less than 1.5% $L_S$ abaft the stem measured at the top of the horizontal step

KEY:

$L_S$  is the subdivision length, in m

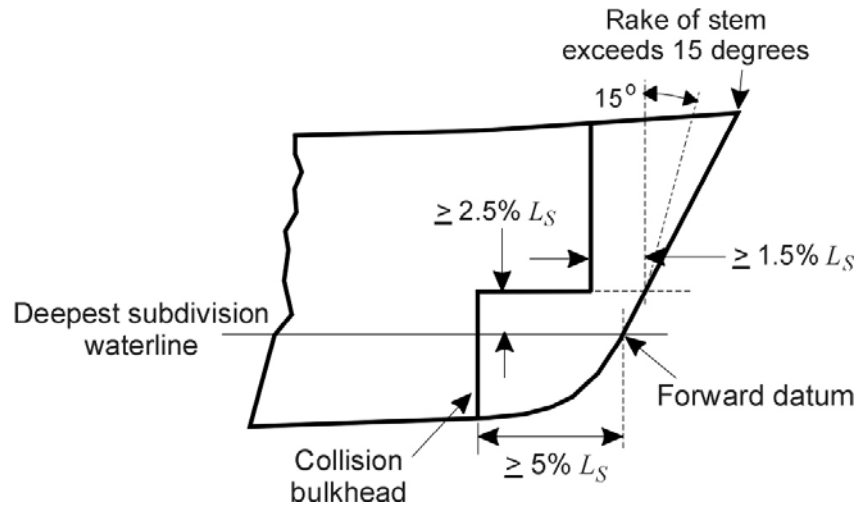

**Figure 8 — Requirements for steps in collision bulkheads**

**7.3.7 Special provisions for bow collision on collared vessels with inflated collars**

Collared vessels of any length having an inflated collar at the bow shall comply with the criteria specified in Table 18 assuming that the two largest forward-most inflated chambers are deflated by the collision.

NOTE: At least one adjacent partition between air chambers is assumed to fail as a result of the collision.

**Table 18 — Criteria for bow damage on collared vessels having an inflated collar**

<b>Flooding Risk Category</b>	<b>Criteria</b>
Sheltered waters FLRC I (Operational areas D or E)	Basic flotation as per Clause 8.6 (1)
Seagoing FLRC I (Operational areas A, B, B20 or C)	Level flotation as per Clause 8.7 (1)
FLRC II	Level flotation as per Clause 8.7 (1)
FLRC III or IV	Table 15 and Table 16 assuming the relevant loss of buoyancy in the inflated collar at the bow (2)

KEY:

- (1) Additional reliability provisions in Table 30 or Table 32 need not apply.
- (2) Method 1 in Table 16 still applies provided after ends of the deflated collars do not extend abaft the collision bulkhead.

**7.4 MEASURES TO REDUCE THE CONSEQUENCES OF SIDE COLLISION**

**7.4.1 Application**

Vessels that carry greater than 36 passengers shall be designed and constructed to comply with the requirements of Clause 7.4.

#### 7.4.2 Requirements for compartment boundaries

The boundaries of the compartments shall comply with the provisions applicable to watertight boundaries specified in CHAPTER 9.

#### 7.4.3 Extent and standard of protection

The vessel shall be arranged to provide the extent of protection specified in Table 19.

**Table 19 — Additional measures to control the consequences of collision on vessels of Flooding Risk Category III or IV**

Number of passengers	Extent of protection	Standard of protection
400 or more	Entire length	Two-compartment, refer to Table 21
37 to 399	Entire length abaft the collision bulkhead	One-compartment, refer to Table 21
36 or less	No requirement (1)	No requirement (1)

KEY:

- (1) Many of the Measures to control consequences of local flooding that are specified in CHAPTER 5 will also provide some protection from side collision; however, the extent of such protection is quite limited; i.e., no bulkhead can be damaged.

#### 7.4.4 Standard for compliance

The watertight compartments shall be arranged so that, for the extent and standard of protection specified in Table 19, the vessel will, when subject to the extent of damage specified in Table 21 comply with the criteria specified in Clause 8.4, and where applicable Clause 8.5.

#### 7.4.5 Special provisions for side damage on collared vessels with inflated collars

Collared vessels within the application specified in Clause 7.4.1 that have an inflated collar along the sides shall apply the extent of protection specified in Clause 7.4.3 assuming that, in addition to any inflated air chamber being deflated by damage, the largest adjacent inflated air chamber shall also be assumed deflated.

NOTE: At least one adjacent partition between air chambers is assumed to fail as a result of the collision.

#### 7.4.6 Flooding of enclosed Ro-Ro spaces due to side collision

##### 7.4.6.1 Application

This Clause applies to enclosed Ro-Ro spaces on a vessel, not being a Ro-Ro space with drainage directly overboard that complies with NSCV Part C Section 2.

NOTE: See also Clause 5.6.

##### 7.4.6.2 Assessing the consequences of side damage

This clause applies to a vessel that is—

- a) Class 1B, 1B20 or 1C;
- b) carries more than 36 passengers; and
- c) has a minimum freeboard to the enclosed Ro-Ro deck when subject to the extent of side damage criteria specified in Clause 7.4.3, that is less than the value specified in Table 20.

The vessel shall comply with the stability criteria specified in Clause 8.4 assuming a quantity of water on deck determined in accordance with Resolution 14 of the 1995 SOLAS Convention (the Stockholm Agreement).

NOTE: For guidance on the application of the Stockholm Agreement, refer to web page: [http://www.redesigngroup.org/lrgtxt/hsc1994apc\\_adt01.pdf](http://www.redesigngroup.org/lrgtxt/hsc1994apc_adt01.pdf)

**Table 20 — Minimum freeboard below which the consequences of flooding of the enclosed Ro-Ro space due to side damage are to be assessed**

Operational area	Minimum freeboard to Ro-Ro deck above the waterline in the damaged condition (m)
B or B20	Applies if minimum freeboard < 2.0 m
C	Applies if minimum freeboard < 1.25 m

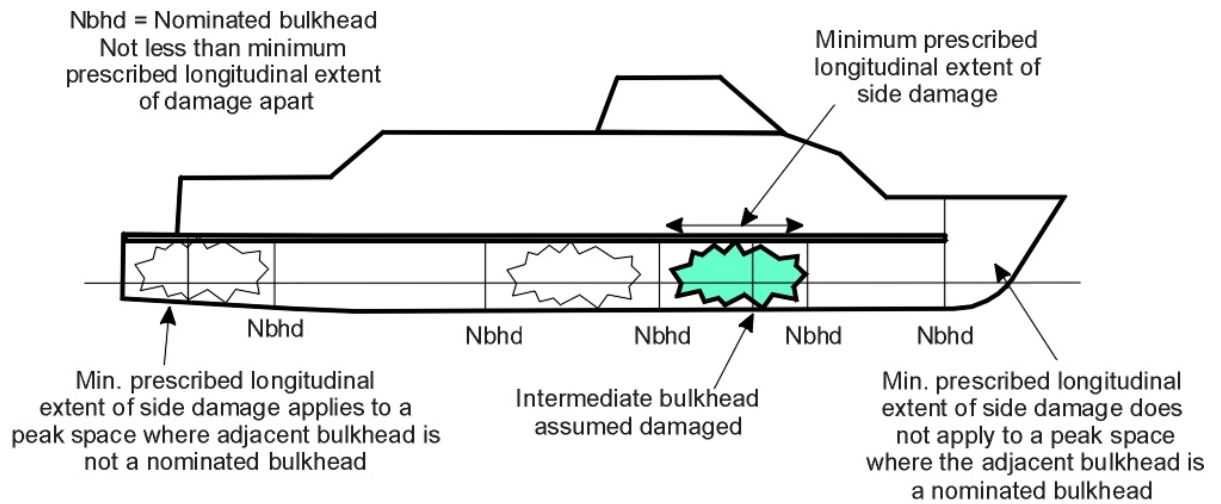

a) One compartment standard

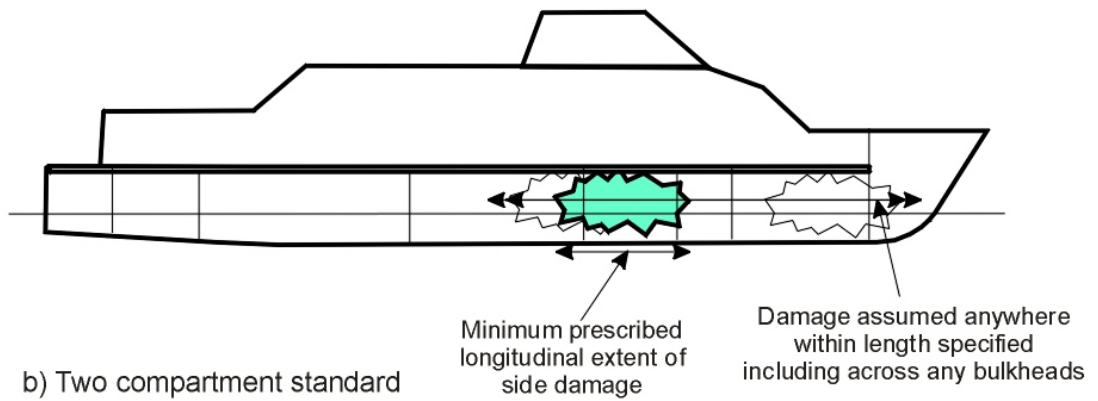

b) Two compartment standard

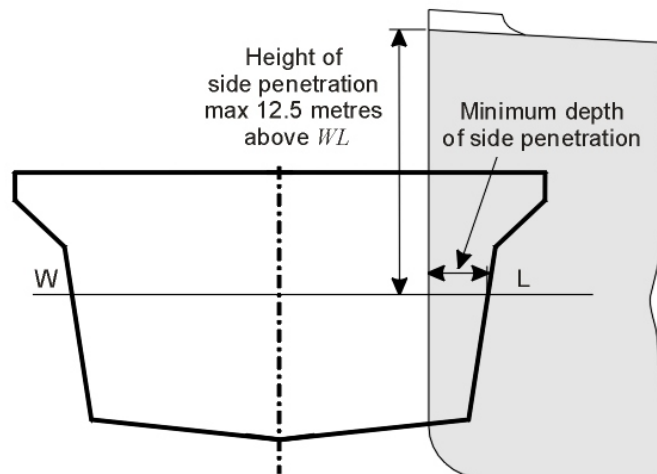

c) Depth of penetration

Figure 9 — Extent of side damage

**Table 21 — Deemed-to-satisfy requirements for the extent of side collision damage**

Number of passengers carried			37 to 399	400 or more
Standard of protection →			One-compartment (see Figure 9a)	Two-compartment (see Figure 9b)
Minimum extent of side collision damage↓				
The longitudinal extent $L_D$ (width of hole) not less than—			Between pairs of nominated transverse bulkheads (1) (2) spaced not less than the longitudinal extent of damage apart. (3)	Anywhere along the hull
FRC III	$L_S$ less than 30 m	$0.10L_S$		
	$L_S$ 30 to 200 m	3 m		
	$L_S$ more than 200 m	$0.015L_S$		
FRC IV	$L_S$ less than 20 m	$0.15L_S$		
	$L_S$ 20 to 100 m	3 m		
	$L_S$ more than 100 m	$0.03L_S$		
$L_S$ = The subdivision length of the vessel, in m.				
The transverse extent (depth of penetration, see Figure 9c) at the deepest subdivision draft not less than the greater of—			Transversely inboard of a vertical plane from the widest point of the section at the longitudinal location	Transversely inboard of a vertical plane from the widest point of the section at the longitudinal location
a)	$0.05B_{dsa}$ or 0.75 m for vessels of Flooding Risk Category III			
b)	$0.1B_{dsa}$ or 0.75 m for vessels of Flooding Risk Category IV			
where				
$B$	= for monohull vessels, the greatest moulded breadth of the vessel at or below the deepest subdivision draft, in m.			
	= for multihull vessels, the greater value of either—			
	a) half the moulded breadth at or below the deepest subdivision draft; or			
	b) the sum of the greatest moulded breadth of each hull at or below the deepest subdivision draft, in m.			
Vertical extent (height of hole, see Figure 9c)			up to 12.5 m above the intact waterline (4)	up to 12.5 m above the intact waterline (4)
Unlimited up to 12.5 m above the intact waterline unless a lesser vertical extent of damage was to result in a more onerous damaged outcome.				

## KEY:

- (1) The more nominated bulkheads, the more likely that damage may sink the vessel by exceeding the extent of protection provided by the deemed-to-satisfy solution.
- (2) Where a collision bulkhead or aft peak bulkhead is a nominated bulkhead, the minimum longitudinal extent of damage need not apply to the forward or aft peak spaces respectively.
- (3) Intermediate bulkheads lying between nominated bulkheads shall be assumed to be damaged see Figure 9a.
- (4) Note that the vertical extent of damage may vary if a reduced height results in a more onerous damaged outcome.



**7.4.7 Vertical height of bulkheads**

Bulkheads shall be watertight up to the bulkhead deck.

**7.4.8 Steps or recesses in bulkheads below the level of the bulkhead deck****7.4.8.1 Potentially vulnerable steps or recesses**

Potentially vulnerable steps or recesses are those that would increase the likelihood of more than one compartment being flooded when exposed to the assumed extent of damage specified in Table 19.

**7.4.8.2 Spaces containing machinery or systems important for safety**

Potentially vulnerable steps or recesses shall not be fitted in the boundaries of spaces containing machinery or systems important for the safety of the vessel.

**7.4.8.3 Spaces subject to a one-compartment standard of protection**

This clause applies to vessels subject to a one-compartment standard of protection as specified in Table 19.

NOTES:

1. The effect of steps and recesses is already taken into account in the extent of side damage that applies a two-compartment standard of protection.
2. In general, the number and extent of vulnerable steps or recesses in the bulkheads of a vessel should be kept to the minimum necessary.

Potentially vulnerable steps or recesses in bulkheads, where fitted, shall comply with the following requirements:

- a) The minimum distance between the vulnerable portions of the stepped or recessed bulkhead to the adjacent nominated transverse bulkhead is not less than the required minimum longitudinal extent of damage  $L_D$  from Table 21.
- b) The total length of potentially vulnerable steps or recesses on a vessel shall not be greater than the lesser value of—

$$0.1L_S \quad \text{or} \quad L_V$$

where

$L_S$  = the subdivision length, in m

$L_V$  = the length of vulnerable steps or recesses considered equivalent to a reduced number of bulkheads; in m

$$= \text{the greater value of } \frac{L_D}{4} \left( \frac{L_S}{L_D} - N_B - N_S - 1 \right) \text{ or } 0$$

where

$L_D$  = the required minimum longitudinal extent of damage from Table 21; in m

$N_B$  = the number of nominated transverse bulkheads (counting stepped or recessed bulkheads as a single bulkhead)

$N_V$  = the number of potentially vulnerable stepped or recessed bulkheads that are also nominated transverse bulkheads.

## 7.5 MEASURES TO REDUCE THE CONSEQUENCES OF RAKING DAMAGE ON COLLARED VESSELS WITH AN INFLATED COLLAR

Collared vessels of any length having an inflated collar at the sides shall comply with the criteria specified in Table 22 assuming that the entire buoyancy in a tube, from the centre line at the stem to the transom, on one side has been deflated by raking damage.

NOTE: On vessels having more than a single tube comprising the collar, only the largest tube need be assumed damaged.

**Table 22 — Criteria for raking side damage on collared vessels having an inflated collar**

<b>Flooding Risk Category</b>	<b>Criteria</b>
Sheltered waters FLRC I (Operational areas D or E)	Basic flotation as per Clause 8.6 (1)
Seagoing FLRC I (Operational areas C)	Level flotation as per Clause 8.7 (1)
FLRC II	Level flotation as per Clause 8.7 (1)
FLRC III or IV	Clause 8.4

KEY:

(1) Additional reliability provisions in Table 30 or Table 32 need not apply

## CHAPTER 8 CRITERIA FOR BUOYANCY AND STABILITY AFTER FLOODING

### 8.1 SCOPE

This Chapter specifies the minimum deemed-to-satisfy criteria for buoyancy and stability after flooding.

### 8.2 APPLICATION

The provisions of this Chapter shall apply to vessels where specified within CHAPTER 4 to CHAPTER 7, see Table 23.

**Table 23 — Application of the criteria for buoyancy and stability after flooding**

Criteria clause reference	Description of criteria for buoyancy and stability after flooding	Clause references to application				
		Swamping	Local flooding	Grounding	Bow collision	Side collision
8.4	Comprehensive stability and buoyancy in the equilibrium flooded condition	N/A	5.5	6.5.2 6.6.2	7.3.4, 7.3.7*	7.4.4 7.4.5,* 7.5*
8.5	Comprehensive stability during intermediate stages of flooding (1)	N/A	5.5 5.7	6.5.2 6.6.2	7.3.4 7.3.7*	7.4.4 7.4.5,* 7.5*
8.6	Basic flotation criteria	4.4	5.5	Nil	7.3.7*	7.5*
8.7	Level flotation criteria	4.4	5.5	Nil	7.3.7*	7.5*

KEY:

(1) Only applies to vessels of Flooding Risk Category IV, certain Ro-Ro vessels and landing craft.

\* Applies only to vessels having an inflated collar.

### 8.3 REQUIREMENTS FOR DETERMINING THE FLOODED CONDITION FOR THE APPLICATION OF COMPREHENSIVE CRITERIA

#### 8.3.1 Initial loading condition prior to flooding

The criteria for flooding shall be applied to the vessel over the range of likely operating conditions corresponding to those analysed for compliance with the intact stability criteria specified in NSCV Part C Subsections 6A and 6C, taking into account the relevant initial combination of draft, trim, stability and free surface.

#### 8.3.2 Space permeability

The flooded condition shall be determined accounting that the contents of a space prior to flooding will limit the actual quantity of water that floods into the space to a volume less than the gross volume of the space. The deemed-to-satisfy values for the assumed permeability of a space shall be as specified in Table 24.

**Table 24 — Values for space assumed permeability (1)**

Description of space	Description of intact loading condition		
	Fully laden	Partly laden	Light
Intended for stores	0.60	0.60	0.60
Used for accommodation	0.95	0.95	0.95
Containing machinery	0.85	0.85	0.85
Void spaces	0.95	0.95	0.95
Intended for liquids	0 or $0.95 \times \delta_p$ or 0.95 (2)	0 or $0.95 \times \delta_p$ or 0.95 (2)	0 or $0.95 \times \delta_p$ or 0.95 (2)
Dry cargo spaces	0.70	0.80	0.95
Container spaces	0.70	0.80	0.95
Ro-Ro spaces	0.90	0.90	0.95
Cargo liquids	0.70	0.80	0.95
Foam	0.05	0.05	0.05
Unverified poured foam	0.15	0.15	0.15

KEY:

$\delta_p$  is the difference between the relative densities of the flooding water and the liquid contents of the space to take into account dispersal of the tank contents and replacement by flooding water.

(1) Values of actual permeability determined by direct calculation would be considered as a proposal for an equivalent solution.

(2) Whichever results in the more severe requirement, also taking into account any escape of liquids in a near full deep tank or additional liquids in a partially filled tank.

### 8.3.3 Buoyancy provided by means other than watertight compartments

Buoyancy provided by low-density flotation materials or air chambers used to reduce the permeability of compartments shall be considered a proposal for an equivalent solution. Acceptance shall be subject to the buoyancy arising from these sources being no less effective and reliable than buoyancy derived from compartments alone, taking the following into account:

- a) The location of the low-density flotation materials or air chambers relative to any assumed extent of damage.
- b) The vertical location of low-density flotation materials or air chambers relative to the damaged waterline.
- c) The means of attachment of the low-density flotation materials or air chambers to the vessel so that the buoyancy force is transferred to support the weight of the vessel.
- d) The initial and ongoing reliability and stability of the low-density flotation materials or air chambers.

NOTES:

1. See CHAPTER 10 for requirements for low-density flotation materials and air chambers.

2. Conservative assumptions as to reliability are often applied to air chambers used for buoyancy (see Table 30 and Table 32).
- e) Other risk factors such as any fire hazard arising from the low-density flotation materials or air chambers, relative to the fire risks associated with the space in which they are contained.

#### **8.3.4 Progressive flooding**

The following requirements shall be applied when determining the equilibrium flooded condition for application of the criteria in Clauses 8.4, 8.6 and 8.7:

- a) The final waterline after flooding, taking into account sinkage, heel and trim, shall be below the lower edge of any opening through which progressive flooding may take place.
- b) Air pipes and openings that are closed by means of weathertight doors or covers shall be considered openings through which progressive flooding may take place.
- c) Openings closed by means of watertight appliances complying with NSCV Part C Section 2 that are normally kept closed when the vessel is underway need not be considered openings through which progressive flooding could take place.
- d) Watertight doors in bulkheads complying with CHAPTER 9 that are to be secured closed while at sea or are remotely operated sliding watertight doors need not be considered openings through which progressive flooding will take place.
- e) Pipes, ducts or tunnels that are located within the extent of penetration of damage shall be considered openings through which progressive flooding will take place unless effective arrangements are provided that will prevent progressive flooding.

### **8.4 COMPREHENSIVE STABILITY AND BUOYANCY IN THE EQUILIBRIUM FLOODED CONDITION**

#### **8.4.1 State of vessel**

The criteria specified under Clause 8.4 shall be applied to the vessel as described in Clause 8.3, assuming that flooding has ceased and a state of equilibrium has been reached.

#### **8.4.2 Flooded freeboard criteria**

After being subject to the specified extent of flooding (refer to Table 23), a vessel that complies with the relevant criteria specified in Table 25 shall be deemed-to-satisfy the flooded freeboard criteria.

**Table 25 — Flooded freeboard criteria**

<b>Criterion No.</b>	<b>Limits on application</b>	<b>Criterion description</b>
FF.1	Refer to Clause 8.2	<p>The final waterline shall be below the level of any opening through which further flooding could take place by the vertical distance specified as follows:</p> $F_f = H_{cs} + 75$ <p>where</p> <p><math>F_f</math> = the minimum freeboard in the equilibrium flooded condition from the flooded waterline to the lowest edge of a sill or coaming, in mm</p> <p><math>H_{cs}</math> = the minimum required coaming or sill height for weathertight integrity from the deck to the lowest edge of a sill or coaming specified in Part C Section 2, in mm</p>
FF.2	Refer to Clause 8.2 Vessels in Operational Areas A, B and C	The vessel shall have positive freeboard from the damage waterline to survival craft embarkation positions
FF.3	Refer to Clause 8.2	The vessel shall have positive freeboard sufficient to ensure important emergency equipment, emergency radios, power supplies and public address systems needed for organising the evacuation remain accessible and operational
FF.4	Refer to Clause 8.2	The vessel shall have positive freeboard such that, within the range of positive stability governed by the criteria of Clause 8.4.4, openings that are neither watertight or weathertight through which further flooding could take place shall not be submerged.

### 8.4.3 Equilibrium angle criteria

After being subject to the specified extent of flooding, a vessel that complies with the relevant criteria specified in Table 26 shall be deemed-to-satisfy the equilibrium angle criteria.

Table 26 — Equilibrium angle criteria

Criterion No.	Limits on application	Criterion description	
EA.1a	Refer to Clause 8.2 Class 1 vessels	The maximum permissible angle of the deck to the horizontal after equilibrium shall not exceed the angle specified as follows:	
		Maximum allowable angle	Conditions of application
		7 degrees	None specified
		12 degrees	All heavy masses including deck and other cargo but not including vehicles are secured against shifting.
		15 degrees	a) All heavy masses including vehicles are secured against shifting. b) Furniture is fixed when in use and/or when stowed. c) Sufficient grab rails are provided in spaces that normally contain persons and in accessways to embarkation points. d) Decks and deck surfaces are arranged to reduce slipping hazards.
EA.1b	Refer to Clause 8.2 Class 2 or 3 vessels	The maximum permissible angle of the deck to the horizontal after equilibrium shall not exceed the angle specified as follows:	
		Maximum allowable angle	Conditions of application
		7 degrees	None specified
		12 degrees	All heavy masses including deck and other cargo but not including vehicles are secured against shifting.
		25 degrees	a) All heavy masses including vehicles are secured against shifting. b) Furniture is fixed when in use and/or when stowed. c) Sufficient grab rails are provided in spaces that normally contain persons and accessways to embarkation points. d) Decks and deck surfaces are arranged to reduce slipping hazards.

#### 8.4.4 Flooded $G_FZ$ curve criteria for Class 1 vessels

After being subject to the specified extent of flooding, a vessel that complies with the relevant criteria specified in either Alternative A given in

Table 27 or Alternative B given in Table 28 shall be deemed-to-satisfy the flooded  $G_FZ$  curve criteria.

**Table 27 — Flooded  $G_FZ$  curve criteria – Alternative A**

Criterion No.	Limits on application	Criterion description
FCA.1a	Refer to Clause 8.2 Class 1B, 1B20, 1C and 1D	The range of positive righting lever $R_\theta$ shall be at least 15 degrees.
FCA.1b	Refer to Clause 8.2 Class 1E	The range of positive righting lever $R_\theta$ shall be at least 10 degrees.
FCA.2a	Refer to Clause 8.2 Vessels carrying more than 400 day passengers or more than 36 berthed passengers	<p>The probability of survival factor <math>s_{final}</math> calculated as follows shall not be less than 0.9.</p> $s_{final} = s_{env} \times s_{mmt}$ <p>where</p> <p><math>s_{final}</math> = the probability of survival factor of the vessel in final equilibrium flooded condition</p> <p><math>s_{env}</math> = the probability of surviving environmental motion</p> $= K \left( \frac{G_FZ_{max}}{0.12} \times \frac{R_\theta}{16} \right)^{0.25}$ <p>where</p> <p><math>G_FZ_{max}</math> = the lesser value of—</p> <ol style="list-style-type: none"> <li>The maximum value of <math>G_FZ</math> on the righting lever curve corresponding to the equilibrium flooded condition, in m, or</li> <li>0.12 m</li> </ol> <p><math>R_\theta</math> = the lesser value of—</p> <ol style="list-style-type: none"> <li>The range of positive stability between the equilibrium angle of heel <math>\theta_e</math> and the lesser value of either the point of vanishing stability or the first point of downflooding, in degrees, or</li> <li>16 degrees</li> </ol> <p><math>K</math> = 1, if <math>\theta_e \leq 7</math> degrees  = 0, if <math>\theta_e \geq 15</math> degrees  = <math>\sqrt{\frac{15 - \theta_e}{8}}</math>  if <math>\theta_e</math> lies between 7 and 15 degrees</p>



**Table 27 — (continued)**

Criterion No.	Limits on application	Criterion description
		<p> <math>S_{mmt} =</math> the probability of surviving heeling moments  <math>= \frac{\Delta(G_F Z_{max} - 0.04)}{M_{heel}}</math> </p> <p>where</p> <p> <math>\Delta =</math> the intact displacement of the vessel prior to flooding, in tonnes  <math>G_F Z_{max} =</math> the maximum value of <math>G_F Z</math> on the righting lever curve corresponding to the equilibrium flooded condition, in m  <math>M_{heel} =</math> the maximum value of <math>M_{pf}</math>, <math>M_{wf}</math> and <math>M_{sf}</math> </p> <p>where</p> <p> <math>M_{pf} =</math> the passenger heeling moment in the flooded condition calculated in accordance with <math>M_p</math> in NSCV Subsection 6A but assuming that passengers are only on decks for embarkation or assembly, in tm  <math>M_{wf} =</math> the wind heeling moment in the flooded condition calculated in accordance with <math>M_w</math> in NSCV Subsection 6A but assuming a wind pressure of 120Pa, in tm  <math>M_s =</math> the survival craft launching heeling moment calculated as the difference in moment between all davit launched survival craft along one side deployed ready for launching carrying all persons as intended in the emergency plan and all the survival craft along the other side in their stowed position                 </p>
FCA.2b	<p>Refer to Clause 8.2</p> <p>Vessels carrying less than 400 day passengers and less than 36 berthed passengers</p>	<p>The probability of survival factor <math>s_{final}</math> calculated as follows shall not be less than 0.9.</p> $s_{final} = s_{env}$ <p>where</p> <p> <math>s_{final} =</math> the probability of survival factor of the vessel in final equilibrium flooded condition  <math>s_{env} =</math> the probability of surviving environmental motion                 </p> $= K \left( \frac{G_f Z_{max}}{0.12} \times \frac{R_\theta}{16} \right)^{0.25}$ <p>where</p>

Table 27 — (continued)

Criterion No.	Limits on application	Criterion description
		$G_F Z_{max}$ = the lesser value of— <ul style="list-style-type: none"> <li>a) the maximum value of <math>G_F Z</math> on the righting lever curve corresponding to the equilibrium flooded condition, in m, or</li> <li>b) 0.12 m</li> </ul> $R_\theta$ = the lesser value of— <ul style="list-style-type: none"> <li>a) the range of positive stability between the equilibrium angle of heel <math>\theta_e</math> and the lesser value of either the point of vanishing stability or the first point of downflooding, in degrees, or</li> <li>b) 16 degrees</li> </ul> $K$ = 1, if $\theta_e \leq 7$ degrees = 0, if $\theta_e \geq 15$ degrees = $\sqrt{\frac{15 - \theta_e}{8}}$ if $\theta_e$ lies between 7 and 15 degrees

Table 28 — Flooded  $G_F Z$  curve criteria – Alternative B

Criterion No.	Limits on application	Criterion description
FCB.1	Refer to Clause 8.2 Class 1B, 1C, 1D and 1E	The range of positive righting lever in the equilibrium flooded condition shall be at least 10 degrees.
FCB.2a	Refer to Clause 8.2 Class 1B, 1C and 1D	The positive area under the righting lever curve in the equilibrium flooded condition, up to the lesser value of the range of positive stability or 27 degrees shall not be less than $0.86 \left( \frac{15}{R_\theta} \right) \text{ in metre degrees}$ where $R_\theta = \text{the lesser value of either 15 degrees or the range of positive stability between the equilibrium angle of heel } \theta_e \text{ and the lesser value of either the point of vanishing stability or the first point of downflooding, in degrees}$
FCB.2b	Refer to Clause 8.2 Class 1E vessels	The positive area under the righting lever curve shall not be less than 0.86 metre degrees.

Table 28 — (continued)

Criterion No.	Limits on application	Criterion description
FCB.3	Refer to Clause 8.2 Vessels carrying more than 400 day passengers or more than 36 berthed passengers	<p>The minimum value of <math>G_F Z_{max}</math> shall not be less than the lesser value of 0.1 m or that determined by the following:</p> $G_F Z_{max} = \frac{M_{heel}}{\Delta} + 0.04$ <p>where</p> <p><math>\Delta</math> = the intact displacement of the vessel prior to flooding, in tonnes</p> <p><math>G_F Z_{max}</math> = the maximum value of <math>G_F Z</math> on the righting lever curve corresponding to the equilibrium flooded condition, in m</p> <p><math>M_{heel}</math> = the maximum value of <math>M_{pf}</math>, <math>M_{wf}</math> and <math>M_{sf}</math></p> <p>where</p> <p><math>M_{pf}</math> = the passenger heeling moment in the flooded condition calculated in accordance with <math>M_p</math> in NSCV Subsection 6A but assuming that passengers are only on decks for embarkation or assembly, in tm</p> <p><math>M_{wf}</math> = the wind heeling moment in the flooded condition calculated in accordance with <math>M_w</math> in NSCV Subsection 6A but assuming a wind pressure of 120Pa, in tm</p> <p><math>M_s</math> = the survival craft launching heeling moment calculated as the difference in moment between all davit launched survival craft along one side deployed ready for launching carrying all persons as intended in the emergency plan and all the survival craft along the other side in their stowed position</p>

#### 8.4.5 Cross-flooding

No deemed-to-satisfy solution has been specified for arrangements that employ cross-flooding of tanks or compartments in order to correct angles of heel that would otherwise exceed maximum allowable values. Arrangements for cross-flooding shall be considered as a proposal for an equivalent solution and shall be assessed against the intermediate flooding criteria.

NOTE: Factors to be taken into account when assessing cross-flooding arrangements as an equivalent solution include the effect of the large angle of heel prior to equalisation, the need for human intervention to activate the system, location of any controls for operating cross-flooding measures, the time required for equalisation, the effect on stability of the cross-flooding process itself, reliability of the equalisation system, accessibility of components for maintenance, training and competence required of persons who undertake the cross-flooding measures.

## 8.5 COMPREHENSIVE STABILITY DURING INTERMEDIATE STAGES OF FLOODING

### 8.5.1 Application

The stability criteria for intermediate stages of flooding shall be applied where, due to the geometrical configuration of the vessel, its stability during intermediate stages of flooding may be more critical than the stability at equilibrium in Clause 8.4.1. Such circumstances shall include scenarios where:

- The disposition of horizontal boundaries to spaces is such that the *VCG* of flooded water in intermediate stages of flooding could exceed that at the equilibrium condition, see Figure 10 a).
- The disposition of horizontal boundaries to spaces is such that the total free surface of flooded water in the intermediate stages of flooding could exceed the total free surface of flooded water in the equilibrium condition, see Figure 10 a) and Figure 10 b).
- The disposition of vertical longitudinal boundaries between spaces is such that the transverse moment of flooded water during intermediate stages of flooding could exceed the transverse moment of flooded water in the equilibrium condition, see Figure 10 b).
- The change of trim, displacement and/or heel during the intermediate stages of flooding are likely to be such that the vessel's waterplane area will be less than either the initial or final equilibrium waterplane areas, see Figure 10 c).

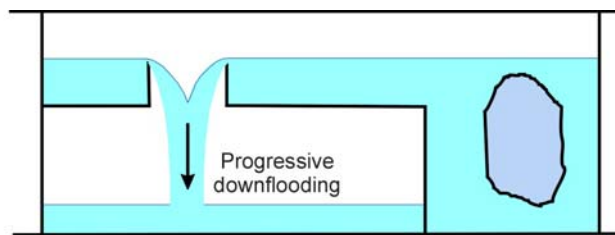

a) Increased intermediate VCG and free surface

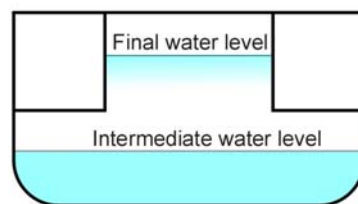

b) Increased intermediate free surface

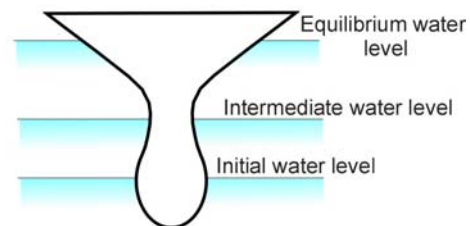

c) Reduced intermediate waterplane area

**Figure 10 — Scenarios requiring intermediate flooding analysis**

### 8.5.2 State of vessel

The criteria specified under this Clause 8.5 shall be applied to the vessel as described in Clause 8.3 but assuming flooding is at the worst case intermediate stage before equilibrium has been reached.

### **8.5.3 Intermediate flooding criteria**

After being subject to the specified extent of flooding, a vessel that complies with the relevant criteria specified in Table 29 shall be deemed-to-satisfy the intermediate flooding criteria.

**Table 29 — Intermediate flooding criteria**

<b>Criterion No.</b>	<b>Limits on application</b>	<b>Criterion description</b>	
IF.1	Refer to Clauses 8.2 and 8.5.1	The maximum permissible angle of the deck to the horizontal during intermediate stages of flooding shall not exceed the angle specified as follows—	
		<b>Maximum allowable angle</b>	<b>Conditions of application</b>
		10 degrees	None specified
		14 degrees	All heavy masses including deck and other cargo but not including vehicles are secured against shifting
		18 degrees	a) All heavy masses including vehicles are secured against shifting; b) Furniture is fixed when in use and/or when stowed; c) Sufficient grab rails are provided in spaces that normally contain persons and accessways to embarkation points; and d) Decks and deck surfaces are arranged to reduce slipping hazards.
IF.2	Refer to Clauses 8.2 and 8.5.1	The maximum value of $G_fZ$ on the righting lever curve corresponding to the intermediate flooded condition, in m shall not be less than 0.05 m	
IF.3	Refer to Clauses 8.2 and 8.5.1	The range of positive stability between the intermediate angle of heel $\theta_i$ and the lesser value of either the point of vanishing stability or the first point of downflooding shall not be less than 7 degrees	

## 8.6 BASIC FLOTATION CRITERIA

### 8.6.1 Application

Clause 8.6 applies to vessels required to have basic flotation, refer to Table 23.

### 8.6.2 Source of buoyancy

The buoyancy referred to in Clause 8.6 may be provided by—

- watertight compartments complying with CHAPTER 9, excluding watertight compartments assumed to be flooded or fully immersed;
- foam buoyancy material complying with CHAPTER 10;
- air chambers complying with the requirements of CHAPTER 10; or
- a combination of these methods.

### 8.6.3 Criteria for basic flotation

A vessel that complies with the requirements of Table 30 and Table 31 shall be deemed-to-satisfy the basic flotation criteria.

**Table 30 — Reliability provisions**

Type of buoyancy	Assumed condition of flooding
Foam buoyancy complying with CHAPTER 10	Apply criteria specified in Table 31 assuming flotation material effective
Rigid air chambers complying with CHAPTER 10	Apply the criteria specified in Table 31 assuming two largest rigid air chambers have been flooded and are not effective
Inflated air chambers complying with CHAPTER 10	Apply the criteria specified in Table 31 assuming the largest inflated air chamber has been deflated and is not effective
Combinations of foam buoyancy complying with CHAPTER 10 and air chambers complying with CHAPTER 10	Apply the criteria specified in Table 31 assuming the larger of - the largest inflated air chamber; or the two largest rigid air chambers are not effective (1)

KEY:

(1) Arrangements employing one or two air chambers in combination with foam buoyancy will still be required to fully rely on the foam buoyancy.

**Table 31 — Basic flotation criteria**

Criterion No.	Limits to Application	Criterion description
BF1	Refer to Clause 8.2	The vessel shall have sufficient buoyancy to keep any portion of the vessel above the surface when the vessel has been submerged in calm, fresh water for at least 18 hours when loaded with the both of the following: <ol style="list-style-type: none"> <li>a) A weight that, when submerged equals 10 per cent of the dry weight of persons on the boat assuming 80 kg per person.</li> <li>b) A weight equal to 25 per cent of the result of the maximum dry dead weight of the vessel minus the dry weight of persons calculated at 80 kg per person.</li> </ol>

### 8.6.4 Alternative criteria for basic flotation

A vessel that complies with the basic flotation test of the following standards, but assuming the mass per person specified in NSCV Part C Subsection 6A, shall also be deemed-to-satisfy the basic flotation criteria for vessels of length and type covered within their scope of application.

ABYC

ISO Small craft & inflatable boats

AS1799

### 8.6.5 Methods of verification

Compliance with the basic flotation criteria shall be verified by either direct calculation or by physical testing or a combination of both methods.

A deemed-to-satisfy method for direct calculation is specified in Annex C.

## 8.7 LEVEL FLOTATION CRITERIA

### 8.7.1 Application

Clause 8.7 applies to vessels required to have level flotation, refer to Table 23.

### 8.7.2 Source of buoyancy

The buoyancy referred to in Clause 8.7 may be provided by—

- a) watertight compartments complying with CHAPTER 9, excluding watertight compartments assumed to be flooded or fully immersed;
- b) foam buoyancy material complying with CHAPTER 10;
- c) air chambers complying with the requirements of CHAPTER 10; or
- d) a combination of these methods.

### 8.7.3 Definitions

#### **level—**

for the purpose of Clause 8.7.4, a vessel is considered to be at a level attitude when it is supported on its keel at the two points shown in Figure 11 b).

#### **person carrying area—**

means each area in a vessel in which persons can sit in a normal sitting position or stand while the vessel is in operation. Person carrying areas are illustrated in Figure 11 a) to Figure 11 g).

#### **length of the person carrying area—**

the distance along the centre line of the vessel between two vertical lines, one at the forward end and one at the aft end of the person carrying area when the vessel is level as illustrated in Figure 11 a) to Figure 11 d). For vessels with a curved stem inside the person carrying area, the forward vertical line is where a line 45 degrees to the horizontal when the vessel is level is tangent to the curve of the stem, as illustrated in Figure 11 d). For vessels with cabins, the forward vertical line is where there is a minimum distance of 600 mm between the inside top of the cabin and the water line formed when the vessel is swamped and loaded with weights as illustrated in Figure 11 a).

#### **breadth of each person carrying area—**

the distance between two vertical lines at the mid-length, excluding consoles, of the person carrying area when the vessel is level as illustrated in Figure 11 e) to Figure 11 g). For vessels with round bilges inside the person carrying area, the vertical line is where a transverse line 45 degrees to the horizontal is tangent to the arc of the bilge, as illustrated in Figure 11 e).

#### **reference area—**

the forward reference area shall be that portion of the gunwale or deck the greater value of either 600 mm or  $0.1L_m$  aft of the moulded line of the stem,



measured at the gunwale or deck as appropriate. Similarly the aft reference area shall be that portion of the gunwale or deck the greater value of either 600 mm or  $0.1L_m$  forward of the moulded line of the stern or transom, measured at the gunwale or deck as appropriate.

NOTE:  $L_m$  is the measured length of the vessel, in m.

**reference depth—**

the minimum distance between the uppermost surface of the submerged reference area of a vessel and the surface of the water measured at the centre line of the vessel, as illustrated in Figure 11 g). If there is no deck surface at the centre line of the vessel from which a measurement can be made, the reference depth is the average of two depth measurements made on opposite sides of, and at an equal distance from, the centre line of the vessel.

**8.7.4 Criteria for level flotation**

A vessel that complies with the requirements of Table 32 to Table 35 shall be deemed-to-satisfy the level flotation criteria.

The criteria apply to the vessel floating in fresh, calm water, taking into account three separate conditions of loading—

- a) the symmetrical fully-laden condition;
- b) the unsymmetrical partially-laden condition; and
- c) the symmetrical light condition.

**Table 32 — Reliability provisions**

<b>Type of buoyancy</b>	<b>Assumed condition of flooding</b>
Foam buoyancy complying with CHAPTER 10	Apply criteria specified in Table 33 to Table 35 assuming flotation material effective
Rigid air chambers complying with CHAPTER 10	Apply the criteria specified in Table 33 to Table 35 assuming two largest rigid air chambers have been flooded and are not effective
Inflated air chambers complying with CHAPTER 10	Apply the criteria specified in Table 33 to Table 35 assuming the largest inflated air chamber has been deflated and is not effective
Combinations of foam buoyancy complying with CHAPTER 10 and air chambers complying with CHAPTER 10	Apply the criteria specified in Table 33 to Table 35 assuming the larger of: the largest inflated air chamber, or the two largest rigid air chambers are not effective (1)

KEY:

- (1) Arrangements employing one or two air chambers in combination with foam buoyancy will still be required to fully rely on the foam buoyancy.

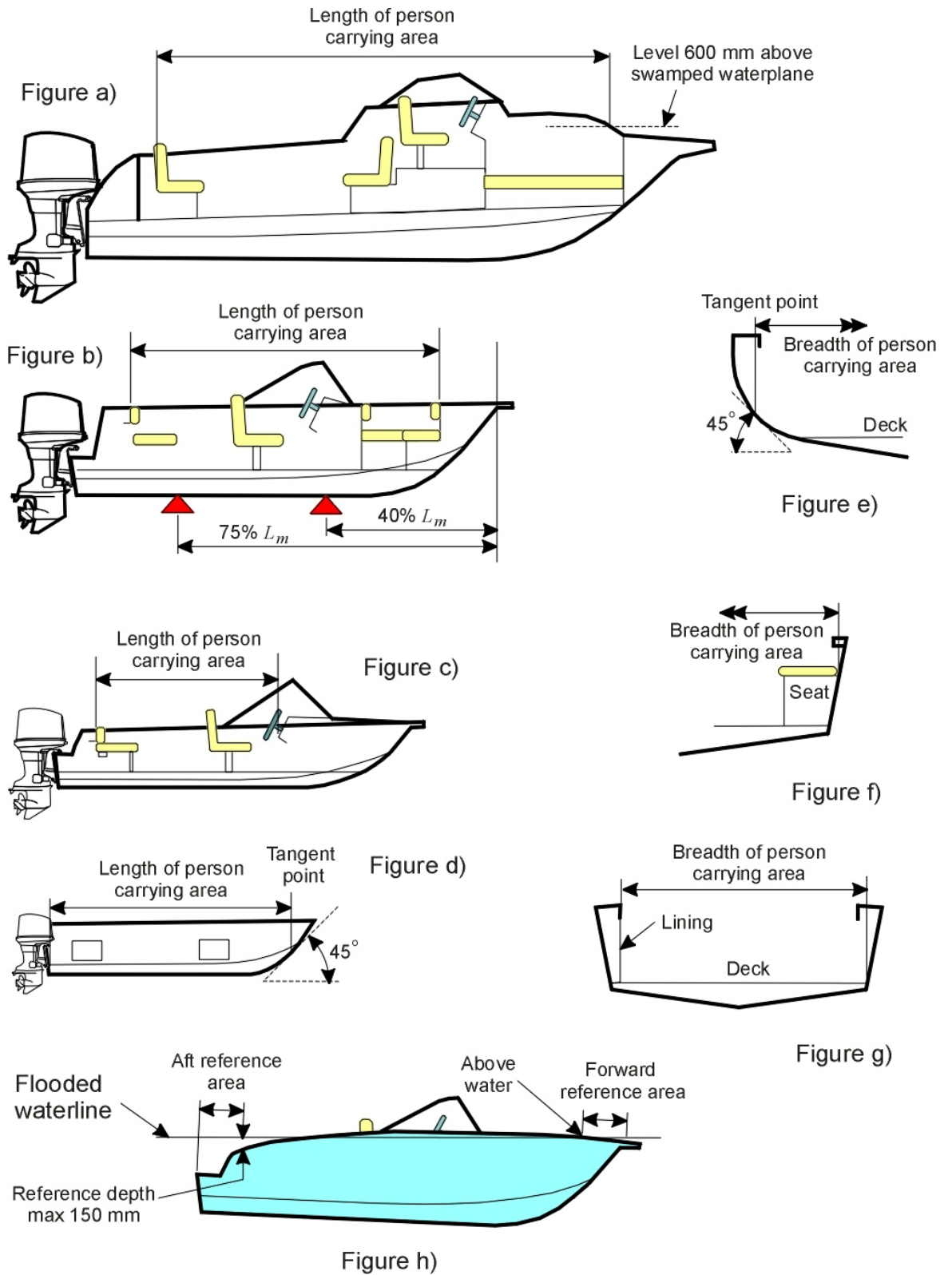

Figure 11 —Illustrations for level flotation criteria

**Table 33 — Level flotation criteria—Symmetrical fully-laden condition (1)**

Criterion No.	Criterion description
LFa1	The vessel shall not heel at an angle greater than 10 degrees from the upright.
LFa2	At least one location on either the forward or aft reference area shall be above the surface of the water.
LFa3	The maximum permissible immersion at the highest point of any immersed reference area shall not be greater than 152 mm, measured at the vessel's centre line.

KEY:

- (1) The vessel shall be in the flooded fully-laden equilibrium condition assuming all persons on board seated and symmetrically distributed. The total weight of persons ( $W_P$ ) shall be calculated assuming not less than 80 kg each person.

**Table 34 — Level flotation criteria—Unsymmetrical partially-laden condition (1)**

Criterion No.	Criterion description
LFb1	At least one location on either the forward or aft reference area shall be above the surface of the water.
LFb2	The maximum permissible immersion in way of the highest point of any immersed reference area shall not be greater than 305 mm, measured at the vessel's centre line.
LFb3	The vessel shall not heel at an angle greater than 30 degrees from the upright.

KEY:

- (1) The vessel shall be loaded with the following weights:
- a) A person weight equal to half the total person weight; i.e. ( $W_P/2$ ) assuming a minimum weight per person not less than 80 kg each.
  - b) A weight ( $W_D$ ) equivalent to the maximum deadweight ( $W_{DWT}$ ) less the total person weight ( $W_P$ ).
- (2) The weights referred to in (1) above shall be distributed as follows:
- a) The weight  $W_D$  shall be located on the centre line of the vessel at the mid-length of the person carrying area.
  - b) The person weight  $W_P/2$  shall be located along one extreme side of the vessel within the passenger area distributed so as to have a longitudinal centre of gravity at the mid-length of the person carrying area. The persons shall be seated on seats, or on the deck in those locations where no seats are fitted.

**Table 35 — Level flotation criteria—Symmetrical light condition (1)**

Criterion No.	Criterion description
LFc1	The vessel shall not heel at an angle greater than 10 degrees from the upright.
LFc2	At least one location on either the forward or aft reference area shall be above the surface of the water.
LFc3	The maximum permissible immersion at the highest point of any immersed reference area shall not be greater than 152 mm, measured at the vessel's centre line.

KEY:

(1) The vessel shall be in the flooded light equilibrium condition without persons or deadweight on board.

### 8.7.5 Methods of verification

Compliance with the level flotation criteria shall be verified by either direct calculation or by physical testing or a combination of both methods.

A deemed-to-satisfy method for direct calculation is specified in Annex C. Guidance on the distribution of flotation material for level flotation is given in Annex D. The method for physical testing is specified in Annex E.

## CHAPTER 9 REQUIREMENTS FOR THE EFFECTIVENESS OF WATERTIGHT COMPARTMENTS TO PROVIDE ADDITIONAL BUOYANCY

### 9.1 SCOPE

This Chapter specifies the minimum deemed-to-satisfy requirements for the construction of watertight boundaries within a vessel in the context of their function to limit the flooding of water.

### 9.2 APPLICATION

The provisions of this Chapter shall apply to all watertight boundaries that are assumed to be watertight for the purposes of compliance with this Subsection.

NOTE: Boundaries that are not essential to compliance are not subject to these provisions. Typically, a boundary is not essential when the vessel meets a higher standard than the minimum specified in this Subsection or the boundary cannot be counted as effective for other reasons such as the minimum extent of damage provisions.

### 9.3 HEIGHT OF WATERTIGHT INTEGRITY

Watertight boundaries shall be watertight up to the level of the bulkhead deck or freeboard deck. This requirement for watertight integrity shall include to the connection of the bulkhead to the bulkhead deck or freeboard deck.

NOTE: A proposal for an equivalent solution may lie where the flooded waterline on a vessel intended for smooth water service lies appreciably below the level of the bulkhead deck.

### 9.4 STRENGTH

Each watertight boundary including any steps or recesses shall be capable of supporting at least the pressure due to a head of water up to the bulkhead deck.

For vessels not required to meet the criteria specified in CHAPTER 8 each watertight boundary including any steps or recesses shall be capable of supporting at least the pressure due to a head of water up to the freeboard deck.

Trunks, tunnels, duct keels and ventilators that pierce watertight boundaries shall also be capable of supporting at least the pressure due to a head of water up to the freeboard deck.

NOTE: Scantlings for watertight boundaries are specified in NSCV Part C Section 3.

### 9.5 MARKING

Each watertight boundary that is not a boundary to a tank shall be marked on both sides to indicate that its watertight integrity is an essential element of the safety of the vessel, see Figure G.1 in Annex G.

## **9.6 PENETRATIONS THROUGH WATERTIGHT BOUNDARIES**

### **9.6.1 Types of penetrations**

Penetrations through watertight boundaries are identified as one of two types:

- a) Service penetrations through which persons do not pass.
- b) Access and inspection penetrations.

### **9.6.2 Service penetrations**

#### **9.6.2.1 *Number to be kept to a minimum***

The number of service penetrations through watertight boundaries shall be reduced to the minimum necessary compatible with the design and proper working of the vessel.

#### **9.6.2.2 *Service penetrations to be watertight***

Where service penetrations such as pipes, scuppers, electric cables, shafts and ventilators are carried through watertight boundaries, arrangements shall be made to ensure the watertight integrity of the bulkheads.

#### **9.6.2.3 *Penetrations in spaces of High Fire Risk***

Within spaces classified as High Fire Risk in NSCV Part C Section 4 on vessel of Flooding Risk Category III or IV, heat sensitive materials shall not be used in systems within the High Fire Risk space that penetrate watertight boundaries, except where deterioration of such systems in the event of fire would not impair the watertight integrity.

EXAMPLE of a heat sensitive material:

ABS plastic piping

#### **9.6.2.4 *Drainage valves not permitted***

Except as otherwise stated in this Subsection, valves shall not be fitted in watertight boundaries to allow drainage past bulkheads unless the valve is part of a self-contained piping system.

#### **9.6.2.5 *Service trunkways***

The fitting of service trunkways shall be avoided where possible. Where service trunkways are carried through watertight boundaries, they shall be made watertight so as not to compromise the watertight integrity of the adjoining spaces. Ventilators and vertical trunks shall be watertight at least up to the bulkhead deck or, on vessels not required to meet the criteria specified in CHAPTER 8, up to the freeboard deck. On vessels of Flooding Risk Category IV, where trunkways are carried through more than one watertight bulkhead, the means of closure at such openings shall be operated by power and be capable of being closed from a central position situated above the bulkhead deck.

#### **9.6.2.6 *Exhaust piping***

Where it is necessary for an exhaust pipe to penetrate a watertight boundary, the exhaust pipe shall be arranged to pass through bulkheads as

high on the bulkhead as practicable. The penetration through the boundary shall be watertight.

### 9.6.3 Access and inspection penetrations

#### 9.6.3.1 Principles of design

All watertight doors shall normally be kept closed during navigation. A watertight door or hatch of width not greater than that specified in Table 36 may be opened during navigation to permit the passage of passengers or crew, or when work in the immediate vicinity of the door necessitates it being opened. The door must be immediately closed and secured when transit through the door is complete or when the task which necessitated it being open is finished.

NOTE: A proposal for a watertight door or hatch to remain open during navigation would need to be considered as a proposal for an equivalent solution having regard to the means for rapid closure and the consequences of the opening being left open in the event of flooding.

**Table 36 — Maximum deemed-to-satisfy clear watertight doorway width for the passage of persons during navigation**

Length of vessel (m)	Maximum width of opening (mm)
35 m or more	1200
Less than 35 m	800

#### 9.6.3.2 Prohibitions on access and inspection penetrations

The number of access and/or inspection penetrations through watertight boundaries shall be kept to the minimum number necessary. Watertight boundaries shall not contain access or inspection penetrations that are not essential to the proper functioning, operation or maintenance of the vessel. Where an access or inspection penetration is essential for the proper operation of the vessel, such penetrations shall only be permitted if reliable measures are provided to ensure that the effectiveness of the watertight boundary will not be compromised at time of need.

Access or inspection penetrations shall not be fitted in the following locations:

- a) In a collision bulkhead below the bulkhead deck.
- b) In a bulkhead separating adjoining cargo spaces below the bulkhead deck that may become inaccessible when cargo is carried.
- c) In a bulkhead adjoining a space normally occupied by persons for which the access penetration would be the only means of escape.

NOTE: Spaces normally occupied by persons include accommodation, machinery spaces, control spaces, steering flats containing emergency steering positions or machinery forming the source of power for steering.

**9.6.3.3 Number in a single watertight boundary to be kept to a minimum**

Not more than one access penetration shall be fitted through any single watertight boundary, except in way of the entrance to shaft tunnels of vessels having more than two screws where a maximum of two access penetrations may be provided.

**9.6.3.4 Size to be kept to a minimum**

The size of access and inspection penetrations shall be kept to the minimum necessary for its safe use. The maximum deemed-to-satisfy clear opening width of watertight doors below the bulkhead deck shall comply with Table 37.

NOTE: See NSCV Part C Section 1 for sizes of doors and escapes used for escape.

**Table 37 — Maximum deemed-to-satisfy clear opening width of access and inspection penetrations through watertight bulkheads**

Type of closure	Maximum width of door (mm)
Power operated (sliding or hinged)	1200
Manual sliding	1200
Manual hinged	800

**9.6.3.5 Access and inspection penetrations to be watertight**

Access and inspection penetrations including doors, man-holes, hatches and hand-holes through watertight boundaries shall be fitted with closing appliances that render them effectively watertight.

**9.6.3.6 Location of penetrations**

Penetrations where fitted through watertight boundaries shall be located as high and as far inboard on the boundary as practicable.

NOTE: This provision has multiple benefits including delaying the time before immersion, reducing the pressure head, protecting from damage and minimising the effect of the vessel heeling.

**9.6.3.7 Marking of access and inspection penetrations**

Access penetrations through boundaries shall be marked on each side of the boundary in bold and permanent lettering—

‘THIS DOOR (OR HATCH) TO BE KEPT CLOSED AND SECURED’.

**9.6.3.8 Specific requirements for watertight doors****9.6.3.8.1 Types of watertight doors**

Three types of watertight doors are defined:

- a) Type 1— Sliding door, operated by power and by manual gear.
- b) Type 2— Sliding door, operated by manual gear only.
- c) Type 3— Hinged door, operated manually.

NOTE: Hinged doors, operated by power and by manual gear are considered as a proposal for an equivalent solution.



### 9.6.3.8.2 Application of Types of watertight doors

The applicable Type of watertight door for a particular application on a vessel shall be in accordance with Table 38.

**Table 38 — Applicable Types of watertight doors**

		<b>Type 1</b>	<b>Type 2</b>	<b>Type 3</b>
		Sliding door, operated by power and by manual gear	Sliding door, operated by manual gear only	Hinged door
<b>Additional limits on application</b>		None	Door sill not more than 4 m below the bulkhead or freeboard deck	Door sill not more than 2.5 m below the bulkhead or freeboard deck Maximum width 800 mm
<b>Flooding Risk Category</b>	I	Required where Type 2 or Type 3 cannot apply	Optional for vessels having no more than four watertight doors per hull (1)	Optional for vessels having one or two watertight doors per hull (1) (2)
	II	Required where Type 2 or Type 3 cannot apply	Optional for vessels having no more than four watertight doors per hull (1)	Optional for vessels having one or two watertight doors per hull (1) (2)
	III	Required where Type 2 or Type 3 cannot apply	Optional for vessels having no more than three watertight doors per hull (1)	Optional for vessels having a single watertight door per hull (1) (2)
	IV	Required where Type 2 cannot apply	Optional for vessels having a single watertight door per hull (1)	Not applicable

**KEY:**

- (1) The number of watertight doors specified is per hull on multihulls provided each of the hulls is fully isolated from each other by watertight boundaries without opening interconnecting penetrations.
- (2) For vessels not subject to extent of bottom or side damage specified in Clauses 6.5 or 7.4, hinged watertight doors additional to the number specified are permitted provided the criteria in Clause 8.4 are still met when the compartments interconnected by hinged watertight doors are all considered flooded.

### 9.6.3.8.3 Construction and performance criteria for watertight doors

Watertight doors shall comply with the requirements specified in Table 39.

NOTE: Within Table 39, (1) refers to IEC 60529 for the degree of protection for—

- a) electrical motors, associated circuits and control components; protected to IPX 7 standard;
- b) door position indicators and associated circuit components; protected to IPX 8 standard; and
- c) door movement warning signals; protected to IPX 6 standard.
- d) The water pressure IPX 8 shall be based on the pressure that may occur at the location of the component during flooding for a period of 36 h.

**Table 39 — Construction and performance criteria for the various types of watertight doors**

Character- istic	<p style="text-align: center;"><b>Type 1</b></p> <p style="text-align: center;">Sliding door, operated by power and by manual gear</p>	<p style="text-align: center;"><b>Type 2</b></p> <p style="text-align: center;">Sliding door, operated by manual gear only</p>	<p style="text-align: center;"><b>Type 3</b></p> <p style="text-align: center;">Hinged door</p>
Indication of status	<p>All power-operated sliding watertight doors shall be provided with means of indication at the operating compartment to show whether each door is open or closed.</p> <p>Each power-operated sliding door shall be provided with a means of indication at the location for its manual closure above the bulkhead deck.</p>	<p>All manually-operated sliding watertight doors shall be provided with means of indication at the operating compartment to show whether each door is open or closed.</p> <p>Each manually-operated sliding door shall be provided with a means of indication at the location for its manual closure above the bulkhead deck.</p>	<p>All hinged watertight doors shall be provided with means of indication at the operating compartment to show whether each door is open or closed. An audible alarm shall be provided at each side of the opening.</p>
Remote power operation	<p>All power-operated sliding doors shall be capable of being closed simultaneously from the central operating console in the operating compartment.</p> <p>The central operating console at the operating compartment shall have a 'master mode' switch with two modes of control: a 'local control' mode which shall allow any door to be locally opened and locally closed after use without automatic closure, and a 'doors closed' mode which shall automatically close any door that is open. The 'doors closed' mode shall automatically close any door that is open. The 'doors closed' mode shall permit doors to be opened locally and shall automatically re-close the doors upon release of the local control mechanism. The 'master mode' switch shall normally be in the 'local control' mode. The 'doors closed' mode shall only be used in an emergency or for testing purposes. Special consideration shall be given to the reliability of the 'master mode' switch.</p> <p>The central operating console at the operating compartment shall be provided with a diagram showing the location of each door, with visual indicators to show whether each door is open or closed. A red light shall indicate a door is fully open and a green light shall indicate a door is fully closed. When the door is closed remotely the red light shall indicate the intermediate position by flashing. The indicating circuit shall be independent of the control circuit for each door.</p> <p>It shall not be possible to remotely open any door from the central operating console.</p>	Not applicable	Not applicable

Table 40 — (continued)

Characteristic	Type 1 Sliding door, operated by power and by manual gear	Type 2 Sliding door, operated by manual gear only	Type 3 Hinged door
Remote manual operation	Each power-operated door shall be provided with a manual means of closure from a location above the bulkhead deck.	Each door shall be provided with a manual means of closure from a location above the bulkhead deck.	Not applicable
Alarms warning of remote operation	Each door shall be provided with an audible alarm, distinct from any other alarm in the area, which will sound whenever the door is closed remotely by power. The alarm shall sound for between 5 s and 10 s before the door begins to move and shall continue sounding until the door is completely closed. Visual alarms shall be provided to supplement the audible alarm in locations having high levels of ambient noise. For remote manual operation it is sufficient for the audible alarm to sound only when the door is moving.	Each door shall be provided with an audible alarm, distinct from any other alarm in the area, which will sound only when the door is moving. Visual alarms shall be provided to supplement the audible alarm in locations having high levels of ambient noise.	Not applicable
Local operation	Controls for opening and closing the door by power shall be located at both sides of the door, see also manual operation. Control handles shall be provided at each side of the bulkhead at a minimum height of 1.6 m above the floor and shall be so arranged as to enable persons passing through the doorway to hold both handles in the open position without being able to set the power closing mechanism in operation accidentally. The direction of movement of the handles in opening and closing the door shall be in the direction of door movement and shall be clearly indicated.	Not applicable	Not applicable
Speed of closure when upright	When all power-operated sliding doors are closed simultaneously, the time from the command being given to the time the last watertight door closes shall not exceed 60 s with the vessel in the upright position. All doors shall have an approximately uniform rate of closure under power. The closure time for any single door, from the time the door begins to move to the time it reaches the completely closed position shall in no case be less than 20 s or more than 40 s with the vessel in the upright position. The time necessary for the complete closure of a single door when closed manually shall not exceed 90 s with the vessel in the upright position.	The time necessary for the complete closure of a single manually operated sliding watertight door shall not exceed 90 s with the vessel in the upright position.	The time necessary for the complete closure (including securing) of a single hinged door shall not exceed 90 s with the vessel in the upright position.

Table 41 — (continued)

Characteristic	Type 1 Sliding door, operated by power and by manual gear	Type 2 Sliding door, operated by manual gear only	Type 3 Hinged door
Manual operation	An individual manually-operated mechanism shall be provided to open and close the door arranged to allow operation from— a) either side of the door; and b) from an accessible position above the bulkhead deck close to the door. A single failure in the electric or hydraulic power-operated systems excluding the hydraulic actuator shall not prevent the manual operation of any door.	An individual manually-operated mechanism shall be provided to open and close the door arranged to allow operation from an accessible position above the bulkhead deck close to the door.	A hinged watertight door shall be fitted with catches or other quick action closing devices capable of being operated from each side of the bulkhead in which the door is fitted.
Instructions for operation	Instructions and directions for operation of doors shall be clearly indicated at all operating positions.	As per Type 1	As per Type 1
Instructions to maintain watertight integrity	Access doors and access hatch covers normally closed at sea, intended to ensure the watertight integrity of internal openings, shall be provided with a notice affixed to each such door or hatch cover to the effect that it is not to be left open. Closing appliances which are kept permanently closed at sea to ensure the watertight integrity of internal openings shall be provided with a notice which is to be affixed to each such closing appliance to the effect that it is to be kept closed. Such notices shall not become obscured when the door is open. Manholes fitted with closely bolted covers need not be so marked.	As per Type 1	As per Type 1
Capacity to close when vessel heeled	The means of operation whether by power or by hand of any power-operated sliding watertight door shall be capable of closing the door with the vessel listed to 15 degrees either way.	The means of operation of any manually-operated watertight door shall be capable of closing the door with the vessel listed to 15 degrees either way.	As per Type 2

Table 42 — (continued)

Character- istic	Type 1 Sliding door, operated by power and by manual gear	Type 2 Sliding door, operated by manual gear only	Type 3 Hinged door
Capacity to close against pressure head	The means of operation whether by power or by hand of any power-operated sliding watertight door shall be capable of closing when water is flowing through the opening applying a static head equivalent to a water height of at least 1 m above the sill on the centre line of the door on either side of the bulkhead.	The means of operation of any manually-operated sliding watertight door shall be capable of closing when water is flowing through the opening applying a static head equivalent to a water height of at least 1 m above the sill on the centre line of the door on either side of the bulkhead.	Hinged watertight doors shall be arranged to open forward or outboard except as follows: a) Doors to spaces of high flooding risk shall open into the space b) Doors to spaces containing important machinery or equipment shall open away from the space.
Protection from damage	Watertight door controls, including hydraulic piping and electric cables, shall be kept as close as practicable to the boundary in which the doors are fitted. Watertight doors and their controls shall be located inboard of any damage zone applicable to the particular vessel.	Watertight doors and their control and/or locking mechanisms shall be located inboard of any damage zone applicable to the particular vessel.	As per Type 2
Reliability of power source	<p>The electrical power required for power-operated sliding watertight doors shall be supplied from the emergency switchboard either directly or by a dedicated distribution board situated above the bulkhead deck.</p> <p>The hydraulic system for power-operated sliding watertight doors shall have hydraulic accumulators of sufficient capacity to operate all the doors at least three times, i.e. closed to open to closed or visa-versa, against an adverse list of 15 degrees. Where the hydraulic system is centralized, it shall have two independent power sources each consisting of a motor and pump capable of simultaneously closing all doors. The power operating system shall be designed to minimize the possibility of having a single failure in the hydraulic piping adversely affect the operation of more than one door. The hydraulic system shall be provided with a low-level alarm for hydraulic fluid reservoirs serving the power-operated system and a low gas pressure alarm or other effective means of monitoring loss of stored energy in hydraulic accumulators. These alarms are to be audible and visual and shall be situated on the central operating console at the operating compartment.</p> <p>The power source for electrically operated sliding watertight doors shall consist of an</p>	Not applicable	Not applicable

Table 42 — (continued)

Character- istic	Type 1 Sliding door, operated by power and by manual gear	Type 2 Sliding door, operated by manual gear only	Type 3 Hinged door
	<p>independent electrical system and motor capable of both opening and closing the door. The power source shall be automatically supplied by the transitional source of emergency electrical power as required by Subsection 5B in the event of failure of either the main or emergency source of electrical power and with sufficient capacity to operate the door at least three times, i.e. closed-open-closed, against an adverse list of 15 degrees.</p> <p>Power systems for power-operated watertight sliding doors shall be separate from any other power system.</p> <p>As far as practicable, electrical equipment and components for watertight doors shall be situated above the bulkhead deck and outside hazardous areas and spaces.</p> <p>The enclosures of electrical components necessarily situated below the bulkhead deck shall provide suitable protection against the ingress of water (1).</p> <p>Electric power, control, indication and alarm circuits shall be protected against fault in such a way that a failure in one door circuit will not cause a failure in any other door circuit. Short circuits or other faults in the alarm or indicator circuits of a door shall not result in a loss of power operation of that door. Arrangements shall be such that leakage of water into the electrical equipment located below the bulkhead deck will not cause the door to open.</p> <p>A single electrical failure in the power operating or control system of a power-operated sliding watertight door shall not result in a closed door opening. Availability of the power supply should be continuously monitored at a point in the electrical circuit as near as practicable to each of the motors required. Loss of any such power supply should activate an audible and visual alarm at the central operating console at the operating compartment.</p>		
Reliability of design	The frames of vertical watertight doors shall have no groove at the bottom in which dirt might lodge and prevent the door closing properly.	As per Type 1	

### **9.6.3.9 Access or inspection tunnels**

#### **9.6.3.9.1 Limitations on use**

Where access or inspection tunnels are carried through watertight boundaries, they shall be located and made watertight so as not to compromise the watertight integrity of the boundary, see also Clause 9.6.3.3. Tunnels located within the assumed extent of damage CHAPTER 6 and CHAPTER 7 shall be assumed flooded for the purposes of the criteria specified in CHAPTER 8.

##### EXAMPLES

Shaft tunnels

Tunnels for movement of crew to accommodation

Service tunnels

#### **9.6.3.9.2 Access requirements**

The access to at least one end of each such a tunnel, if used as a passage when underway, shall be through a trunk extending watertight to a height sufficient to permit access above the bulkhead deck. The access to the other end of the tunnel may be through a watertight door of the type required by its location in the vessel. On vessels carrying more than 36 passengers, such tunnels shall not extend through the first subdivision bulkhead abaft the collision bulkhead.

### **9.6.4 Enclosed Ro-Ro spaces**

#### **9.6.4.1 Trunks in enclosed Ro-Ro spaces**

Where a ventilation trunk passing through a structure penetrates the bulkhead deck, the trunk shall be capable of withstanding the water pressure that may be present within the trunk, after having taken into account the maximum heel angle allowable during intermediate stages of flooding, in accordance with the relevant criteria in CHAPTER 8. Where all or part of the penetration of the bulkhead deck is on the main Ro-Ro deck, the trunk shall be capable of withstanding impact pressure due to internal water motions (sloshing) of water trapped on the Ro-Ro deck.

#### **9.6.4.2 Openings within enclosed Ro-Ro spaces**

Other than vehicle ramps specified in Clause 9.6.4.3, all accesses that lead to spaces below the bulkhead deck shall have a lowest point which is not less than 2.5 m above the bulkhead deck.

#### **9.6.4.3 Vehicle ramps**

Where vehicle ramps are installed to give access to spaces below the bulkhead deck, their openings shall be able to be closed weathertight to prevent ingress of water below. The open or sealed status of the ramp shall be monitored from within the operating compartment by an indicator and an alarm that operates with the ramp is not secured.

## 9.7 ADDITIONAL REQUIREMENTS FOR COLLISION BULKHEADS

The collision bulkhead shall comply with the relevant provisions of Clause 7.3. In addition, the collision bulkhead shall be constructed in accordance with Table 43.

**Table 43 — Additional requirements for collision bulkheads**

Characteristic	Flooding Risk Category IV	Flooding Risk Category I, II and III
Watertight doors in the collision bulkhead below the level of the bulkhead or freeboard deck	Not permitted	Not permitted
Inspection manholes fitted with closely bolted covers below the level of the bulkhead or freeboard deck	Not permitted	One permitted, to be as high as practicable and on the centre line of the vessel. For Flooding Risk Category III, the lower edge of the manhole shall be located above the damaged waterline.
Ventilation ducts	Not permitted	Not permitted
Forepeak tank fluid or bilge piping	One pipe penetration per watertight space contained within the forepeak forward of the collision bulkhead, the pipe to be fitted with a screw-down valve (1) capable of being operated from above the bulkhead deck.	One pipe penetration per watertight space contained within the forepeak forward of the collision bulkhead, the pipe to be fitted with a screw-down valve (1) capable of being operated from either above the bulkhead deck or abaft the collision bulkhead.

KEY:

(1) The valve shall be of a type not prone to brittle failure in the event of collision.

## 9.8 DRAINAGE WELLS IN THE INNER BOTTOM OF A DOUBLE BOTTOM STRUCTURE

The number of wells in the inner bottom shall be kept to the minimum required to drain spaces above the double bottom. The dimensions of a well for drainage of the inner bottom that protrudes into the double bottom space shall be kept to the minimum necessary for collection of water and effective operation of the bilge pump.

The well and its associated bilge piping shall be located so as not to be affected when the vessel is exposed to the applicable assumed extent of damage specified in CHAPTER 6.

NOTES:

1. As a guide to a workable solution, a depth of well not greater than 457 mm has been specified in some prescriptive standards.
2. Wells located on the longitudinal centre line of the vessel are normally less vulnerable to bottom damage because of the protection afforded by the keel structure and the greater height of the double bottom at this location.



## 9.9 VERIFICATION OF WATERTIGHT INTEGRITY

Each watertight boundary including any steps or recesses shall be tested and/or inspected for structural adequacy and/or watertightness with the vessel as an advanced stage of construction in accordance with Table 44.

Guidance on the testing of watertight boundaries is given in Annex H.

**Table 44 — Test requirements for watertight boundaries**

	Tank or boundary to be tested	Test type (1)	Test head or pressure	Remarks
1	<ul style="list-style-type: none"> <li>• Double bottom tanks</li> <li>• Double side tanks</li> <li>• Deep tanks</li> <li>• Peak tanks</li> </ul>	Leak and structural	The greater of— - top of the overflow; - to 2.4 m above top of tank (2); and - to bulkhead deck.	After peak to be tested after installation of stern tube
2	<ul style="list-style-type: none"> <li>• Cargo oil tanks</li> </ul>	Leak and structural	The greater of— - top of the overflow; - to 2.4 m above top of tank (2); and - to top of tank (2) plus setting of any pressure relief valve	
3	<ul style="list-style-type: none"> <li>• Chain locker</li> </ul>	Leak and structural	Top of chain pipe	
4	<ul style="list-style-type: none"> <li>• Watertight bulkheads</li> <li>• Watertight doors below freeboard or bulkhead deck</li> <li>• Shaft tunnel clear of deep tanks</li> </ul>	Leak		
5	<ul style="list-style-type: none"> <li>• Double bottom voids</li> <li>• Double side voids</li> <li>• Peak voids</li> <li>• Cofferdams</li> </ul>	Leak	Excluding hose test	After peak to be tested after installation of stern tube

KEY:

(1) Refer to Annex H.

(2) Top of tank is deck forming the top of the tank excluding any hatchways.

## CHAPTER 10 REQUIREMENTS FOR THE EFFECTIVENESS OF LOW-DENSITY FLOTATION MATERIALS AND AIR CHAMBERS TO PROVIDE ADDITIONAL BUOYANCY

### 10.1 SCOPE

This Chapter specifies the minimum deemed-to-satisfy requirements for the composition and installation of low-density flotation material and the manufacture and installation of air chambers for the purposes of providing additional buoyancy on a vessel when the vessel is subject to flooding.

### 10.2 APPLICATION

The provisions of this Chapter shall apply to low-density flotation material and/or air chambers that have been assumed to contribute to buoyancy for the purposes of compliance with this Subsection. It does not apply to other vessel structures or components that may contribute to buoyancy but have functions that are not primarily for buoyancy.

NOTE: To calculate the required quantity of buoyancy material or volume of air chambers, see CHAPTER 8 and Annex C.

### 10.3 MATERIAL AND STRUCTURAL PROPERTIES

#### 10.3.1 General characteristics

Low-density flotation material and/or air chambers shall have properties that ensure they will perform at time of need in the manner assumed in the relevant flooding criteria. The flotation material and/or air chambers as installed shall be—

- a) impervious to water absorption;
- b) structurally stable under service conditions; and
- c) chemically inert in relation to structural materials with which it is in contact or other substances with which the buoyancy component is likely to be in contact.

#### 10.3.2 Low-density flotation materials

##### 10.3.2.1 *Definition of bilges*

For the purposes of Clause 10.3.2, the bilge space of a vessel shall be defined as specified in Table 45.

##### 10.3.2.2 *Material to be suited to location on vessel*

For the purposes of complying with Clause 10.3.1 a) and b), low-density flotation material shall comply with properties specified in Annex F and Table 46.

**Table 45 — Bilge spaces**

Location	Below a plane parallel to the design waterline located at a height above the lowest point in the compartment at which water can collect, the greater value of
Spaces containing machinery or fuel tanks (1)	300 mm or 10 per cent of the greatest depth of hull within the compartment
Other spaces	100 mm or 5 per cent of the greatest depth of hull within the compartment

KEY:

(1) Includes compartments containing steering gear or stern gland.

**Table 46 — Required classes of low-density flotation material for different flooding risk categories and locations on the vessel**

Application	Required class of low-density flotation material, see Annex F			
	Vessels of Flooding Risk Category I		Vessels of Flooding Risk Category II, III or IV	
	Not encapsulated	Encapsulated	Not encapsulated	Encapsulated
Bilge spaces (1) in spaces containing machinery or fuel tanks (2) (3)	LDFM A	LDFM B	LDFM A	LDFM B
Bilge spaces (1) in spaces not containing machinery or fuel tanks (2) (3)	LDFM B	LDFM C	LDFM B	LDFM C
Machinery spaces not being bilge spaces	LDFM C	LDFM C	LDFM B	LDFM C
Other spaces	LDFM B or C	Not specified	LDFM B	LDFM B or C

KEY:

LDFM A, LDFM B and LDFM C are different grades of low-density flotation materials that comply with the relevant provisions contained in Annex F.

(1) Bilge spaces are defined in Clause 10.3.2.1.

(2) Includes compartments containing steering gear or stern gland.

(3) Assumes that measures are in place to prevent flotation material in bilges being left in contact with bilge water over very long periods.

**10.3.2.3 Encapsulation**

A low-density flotation material shall be considered encapsulated if the foam as encapsulated complies with the relevant requirements specified in Clause 10.3.3 for air chambers.

NOTE: The advantage of applying the encapsulation of foam compared to air chambers is that no allowance for redundancy is required (see Table 30 and Table 32) and the foam may be counted as support for the encapsulating skin.

### **10.3.3 Air chambers**

#### **10.3.3.1 Form**

Air chambers may be either integral to the vessel's structure or of independent construction affixed to, contained within or otherwise incorporated into the vessel.

#### **10.3.3.2 Design head**

Air chambers shall be designed to prevent buckling or a loss of buoyant volume greater than 5 per cent of the air chamber assuming an external pressure head of seawater equivalent to the greater of—

- a) the depth of water  $1.5 T_f$  where  $T_f$  is the distance to the bottom of the air chamber in the flooded condition; or
- b) 1.5 m.

NOTE: The depth of water  $T_f$  will likely be similar to the distance from the lowest point of the low-density flotation material to the gunwale on vessels with level flotation, but may be as much as the length of the vessel beneath the water on vessels with basic flotation.

#### **10.3.3.3 Reliability of the watertight integrity of the air chamber**

Air chambers shall be of robust construction using materials suited to the marine environment.

The chamber shall be designed to withstand normal cyclical air pressure variations due to heating and cooling effects without suffering fatigue, bursting or collapse.

Means shall be provided to enable—

- a) any water contained within each chamber to be ascertained and drained; and
- b) initial and periodic verification that the air chambers do not leak.

NOTE: Such means may include arrangements for tests to show that over an extended period of time the chamber can hold a pressure head or vacuum.

## **10.4 INSTALLATION**

### **10.4.1 Location and securing**

Low-density flotation material and/or air chambers shall be placed and secured so that they will effectively contribute to supporting the mass of the vessel in the relevant flooded conditions. The low-density flotation material and/or air chambers shall be installed so that they cannot be readily moved or floated out of place. The structure enclosing or holding the low-density flotation material and/or air chambers in place shall be sufficiently strong to withstand the buoyancy forces when submerged and any surging forces when flooded spaces are partially filled. Where a vessel is required to meet the assumed extent of damage criteria specified in CHAPTER 6 and/or CHAPTER 7, the low-density flotation material and/or air chambers shall either be—

- a) located so as to be protected from the assumed extent of damage where applicable in CHAPTER 6 and CHAPTER 7; or

- b) on vessels subject to the extent of damage criteria in CHAPTER 6 and CHAPTER 7, installed with sufficient redundancy to allow for a loss of buoyancy contribution corresponding to the assumed extent of damage.

NOTES:

1. The vertical and transverse location of low-density flotation material or air chambers will have a large influence on the vessel's capacity to meet the criteria for level flotation in Clause 8.7. Stability in the flooded condition is generally enhanced by locating buoyancy as high and as far outboard in the vessel as practicable, see Annex D for guidance.
2. Low-density flotation material or air chambers will not be effective if they are floating freely within a partially filled compartment.

#### **10.4.2 Protection from mechanical damage**

Low-density flotation material and/or air chambers shall be protected from degradation that might arise from mechanical loading.

EXAMPLES

Vibrations, slamming accelerations, pedestrian loading, cargo weights, impacts.

#### **10.4.3 Protection from exposure to liquids and/or solvents**

Low-density flotation material and/or air chambers shall be protected from degradation that might arise from exposure to liquids or solvents.

EXAMPLES

Bilge water, fuel, oil, fuel vapours.

#### **10.4.4 Protection from exposure to heat and/or sunlight**

Low-density flotation material and/or air chambers shall be protected from degradation that might arise from long term exposure to heat and/or sunlight.

EXAMPLES

Exposure to heat adjacent to machinery exhaust pipe systems.

#### **10.4.5 Control of fire risk**

Where low-density flotation material or air chambers are installed within a space, the flotation material or the material of construction of air chambers shall not compromise the fire safety measures applied to the space by NSCV Part C Section 4. Either the low-density material/air chambers themselves or the method of installation shall comply with the relevant clauses in NSCV Part C Section 4.

NOTE: Relevant clauses within NSCV Part C Section 4 include—

- a) fire characteristics specified for insulation materials; and
- b) protection of surfaces against oil penetration.

#### **10.4.6 Control of corrosion risk**

Where low-density flotation material in a metal-hulled vessel is installed in locations prone to moisture or water in normal service, the material shall be—

- a) separated from direct contact with metallic surfaces by a membrane or air gap; and
- b) arranged so that it can be removed to allow periodic inspection of the hull and foam.

## NOTES:

1. Locations prone to moisture or water include bilges and on top of exposed decks.
2. This clause effectively precludes as a deemed-to-satisfy solution the use of poured foams in locations prone to moisture or water on a metal-hulled vessel.

## 10.5 POURED FOAM

Poured foam low-density flotation material, where permitted in Clause 10.4, shall comply with BS 5241-2 when dispensed or sprayed on a construction site.

## NOTES:

1. Proper mixing and installation is critical to achieving the required properties.
2. The calculation for the required volume of low-density flotation material contained in Annex C includes a margin of uncertainty for poured foam above the nominal volume requirement. This calculation also provides that the margin need not apply where the density and actual volume of the foam resulting from the pour can be verified.

## 10.6 INFLATED COLLARS

### 10.6.1 Collar materials

#### 10.6.1.1 *General suitability*

All collar materials used in fabric and fittings shall have characteristics of strength, reliability and durability suitable for the intended duty.

#### 10.6.1.2 *Standards for inflated materials*

Materials for inflated components shall be manufactured to AS 2677, ISO 6185, or another equivalent national or international standard.

#### 10.6.1.3 *Quality of inflated materials*

Materials for inflated components shall be independently verified against the applicable standard by one or more of the following methods:

- a) The material shall be tested and specifically listed for the purpose by a NATA approved testing laboratory in Australia.
- b) The material shall be certified by a JAS-ANZ accredited product certification body.
- c) The material shall be approved by a Classification Society.
- d) The material shall be certified by an AMSA-recognised Notified Body in accordance with the EU Marine Equipment Directive, Module B (MED-B).

NOTE: The Register of Compliant Equipment published by the NMSC at [www.nmsc.gov.au](http://www.nmsc.gov.au) provides a listing of equipment and materials that have been verified as complying with relevant standards.

### 10.6.2 Number and disposition of chambers

The inflated collar shall be divided into multiple air chambers individually sealed from each other with an airtight boundary. The minimum number of

individual air chambers in the collar shall not in any case be less than that specified in Table 47. In addition, the number and disposition of inflated air chambers shall be such as to satisfy the relevant extent of flooding criteria specified in Table 3 (or Table 4) for a vessel relying on inflated air chamber buoyancy.

NOTE: A vessel that complies with recreational boat standards such as AS 2677 or ISO 6185 should still be checked against these criteria,

**Table 47 — Minimum number of and size limits for inflated chambers**

Maximum Power Rating ( $P$ ) (kW)	Dimensional Factor ( $F_{INF}$ ) $F_{INF} = L_{OA} \times B$	Nominal minimum number of chambers ( $N$ ) (1), (2)
$P \leq 15$	All	3
$15 \leq P \leq 45$	$\leq 8$	3
	$> 8$	4
$P > 45$	$\leq 8$	4
	$> 8$	5

KEY:

(1) The maximum permissible single inflated chamber volume shall not exceed  $0.4\Delta/N$  ( $m^3$ ), where  $\Delta$  is the maximum displacement of the vessel (in tonnes) and  $N$  is the nominal minimum number of chambers from column 3.

(2) For each inflated chamber of the largest  $N$  (column 3) chambers of volume less than  $0.16\Delta/N$  ( $m^3$ ), the actual minimum number of chambers shall be not less than the nominal value  $N$  increased by one.

$L_{OA}$  is the overall length of the vessel defined in Part B (including any extension of the collars abaft the transom), in m

$B$  is the maximum breadth of the vessel measured to the outside surface of the collars, in m

### 10.6.3 Collar to hull connection

#### 10.6.3.1 Performance requirements

Where the inflated collar is attached to a rigid hull or rigid floor structure, the collar to hull connection shall be designed and constructed to ensure that—

- the inflated components are supported and restrained to the extent necessary for achieving the intended characteristics of buoyancy, stability, watertightness, impact resistance and freeboard;
- the loads from the inflated components are effectively transmitted to the rigid structure;
- the connection will not fail before failure of the collar or rigid structure, unless specifically addressed in the design;
- the inflated components are protected from damage caused by potential chafing or point loading; and
- provision is made to enable the condition of the connection to be monitored during the service life of the vessel.

NOTE: The collar to hull connection is normally by means of mechanical fastening, chemical bonding or a combination of both.

### 10.6.3.2 Design load

The collar to hull connection shall be designed and constructed with sufficient strength to withstand a load not less than—

$$F_B = 2P_b D_c$$

where

- $F_B$  = the minimum force per metre of bonded joint applied pulling the collar from the hull, in kilonewtons
- $P_b$  = the bottom design pressure over the collar considering the collar as a panel as indicated in Figure 12, in kilopascals
- $D_c$  = the diameter of the collar, in m

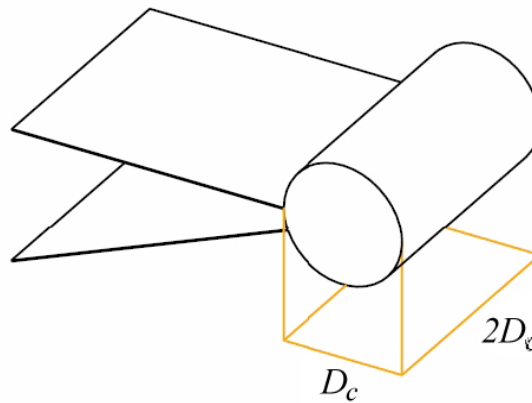
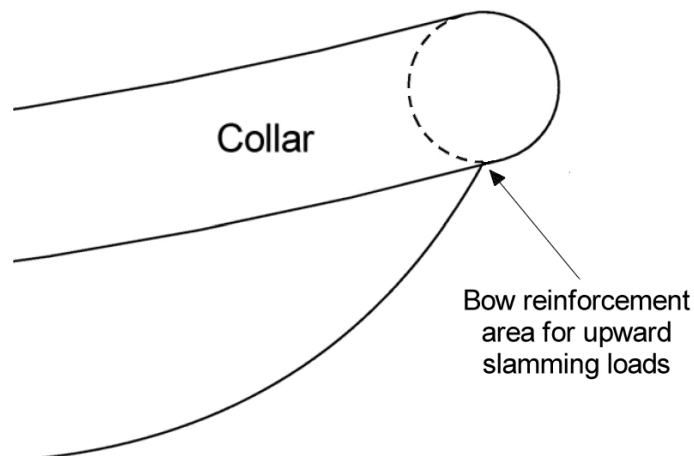

Figure 12 — Assumed panel dimensions for determining the design pressure  $P$

### 10.6.3.3 Local reinforcement

The collar to hull connection shall be locally reinforced to take account of the additional loads at the following locations:

- At the bow to accommodate the upward slamming loads likely to be encountered in service, see Figure 13.
- At the transom on those vessels where the collars extend beyond the transom. The bending moment shall be calculated assuming a force twice the buoyancy force of the collars aft of the point of attachment as shown in Figure 14.



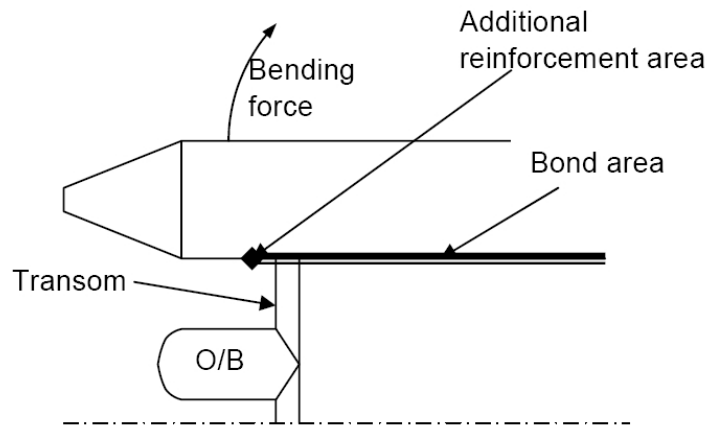

**Figure 13 — Reinforcement at bow****Figure 14 — Reinforcement in way of an overhanging collar****10.6.4 Fittings for inflation and deflation**

Arrangements shall be provided to permit manual inflation and deflation of each individual chamber of the collar independent of all other chambers.

NOTE: Deflation may be by using the inflation valve or by using a separate device.

Valve assemblies shall be of corrosion resistant materials. Valves shall be designed, arranged and/or installed to—

- prevent damage to the inflated chambers;
- permit ready access for connection of the inflation device whether the vessel is on land or in the water;
- avoid inconvenience to persons when seated in their normal seating positions;
- avoid any interference with the operation of the vessel including loading and unloading of the vessel;
- prevent the valves being damaged or torn off by lines, lifelines or movable components of the vessels construction or by normal movements of the passengers and load;
- prevent any cap used to seal the valve from being accidentally lost; and
- allow a controlled reduction in buoyancy chamber pressure.

**10.6.5 Additional tests for inflated collars****10.6.5.1 Collar to hull connection test**

The connection of the collar to the hull shall be tested by applying a force to the connection equal to 95 per cent of the collar bond load as determined in Clause 10.6.3 for not less than 1 min. At the conclusion of the load the connection shall be inspected for signs of physical damage to the connection or connected components. The collar shall be deemed to have failed the collar to hull connection test if there are signs of physical damage.

**10.6.5.2 Collar to life safety fittings connection test**

The connection of the collar to life safety fittings (such as grab ropes or grab handles) shall be tested by applying a static load of not less than 2

kilonewtons in the worst direction for shear and bending for not less than 1 min. At the conclusion of the load the connection shall be inspected for signs of physical damage to the connection or connected components. The collar shall be deemed to have failed the collar to life safety fittings connection test if there are signs of physical damage.

#### **10.6.5.3 Overpressure test**

Each compartment of an inflated collar shall be pressure tested to 1.5 times the manufacturer's design working pressure for 30 minutes. When separate compartments have common envelope parts (for example, internal partition bulkheads, these compartments shall be individually tested with adjacent compartments deflated. The test shall be deemed satisfactory if no damage or rupture occurs.

#### **10.6.5.4 Airtightness Test**

The inflated collar shall be tested for airtightness in accordance with the following procedure:

- a) The collar shall be supported or insulated from the floor and protected from exposure to draught of air or direct sunlight.
- b) All the compartments of the collar shall be inflated for 30 min to a pressure that is 20 per cent in excess of the manufacturer's design working in order to pre-stretch the collar.
- c) The internal pressure shall be reduced to the design working pressure and kept at that point for a further 30 min period in order to stabilise conditions.
- d) Ambient temperature, atmospheric pressure and the pressure within each collar compartment shall be measured and recorded.
- e) Following a test period of 24 hours, the ambient temperature, atmospheric pressure and the pressure within each collar compartment shall again be measured and recorded.
- f) The atmospheric pressure difference between the between the two sets of test readings d) and e) shall not exceed  $\pm 1$  per cent.
- g) The temperature difference between the two sets of test readings d) and e) shall not exceed  $\pm 3^{\circ}\text{C}$ .
- h) Each final recorded collar pressures shall be reduced or increased by an amount of 0.004 bar for each rise or fall in ambient temperature of  $1^{\circ}\text{C}$ , respectively.

The collar shall be deemed to have failed the airtightness test if the pressure drop in any one compartment adjusted in accordance with h) exceeds 20 per cent over the 24 hour period.

#### **10.6.6 Means to repair and reinflate collars**

All vessels that rely on inflated collars for compliance with NSCV Part C Subsections 6A and 6B shall be provided with—

- a) a collar repair kit sufficient to make temporary repairs to small punctures and tears of up to 20mm in diameter; and
- b) a means of re-inflating a repaired collar.

NOTE: Instructions for repair and reflation of collars shall be provided, see NSCV Part C Subection 6C.

## CHAPTER 11 SUBDIVISION LOAD LINE

### 11.1 APPLICATION

Vessels of Flooding Risk Category III or IV that are not required to be marked with a load line in NSCV Part C Section 2 shall be marked with a subdivision load line corresponding to the minimum allowable freeboard obtained from the worst case maximum loading condition for compliance with the criteria for buoyancy and stability after flooding contained in this Subsection. However, in no case shall the displacement corresponding to the subdivision load line exceed the maximum displacement corresponding to—

- a) the design scantling draft assumed for the application of NSCV Part C Section 3; and
- b) loading conditions that comply with the intact stability criteria specified in NSCV Part C Subsection 6A.

NOTE: Compliance with the relevant criteria in this Subsection is also a key parameter for determination of the load line on vessels required to have a load line under Part C Section 2.

### 11.2 MULTIPLE MODES OF OPERATION

A vessel intended for alternating modes of operation may have additional subdivision load lines assigned and marked to correspond with the critical operating condition for each subdivision draft. The freeboard corresponding to each of these load lines shall be measured at the same position.

### 11.3 MARKING

The subdivision load line shall be marked in accordance with the following:

- a) The subdivision load line shall be marked on each side of the vessel amidships.
- b) The load line shall consist of a horizontal line 25 mm in breadth and 230 mm in length.
- c) The upper edge of the horizontal line shall be placed at a distance below the deck line equal to the freeboard that corresponds to that subdivision load line.

NOTE: For a definition and details of the location of the deck line, refer to NSCV Part C Section 2.

- d) The marks shall be identified with the letter N. If more than one subdivision load line is assigned to the vessel, consecutive numbers shall be added beginning from the mark indicating the position of the deepest subdivision load line assigned to the vessel; i.e., 'N1, N2, etc'.
- e) The load line mark and identifying letters (and where applicable numbers) shall be permanently marked and highlighted by painting in white or yellow on a dark background or in black on a light background.

NOTES:

1. Permanent marking on steel or aluminium vessels is normally by welding of pre-cut components, cutting-in or centre-punching.
2. Permanent marking on wooden vessels is normally by cutting-in to a depth of 3 mm or more into the planking.
3. Permanent marking on FRP vessels can be achieved by permanently glueing with structural adhesive pre-glassed coremat markings.

## ANNEX A SUMMARY OF HAZARDS

### A1 SCOPE

Annex A summarises the key flooding hazards addressed by the provisions of this section and other sections of the NSCV. Table A.1 forms the basis for the requirements contained in this Subsection.

This informative Annex is referenced in Clause 1.3 of this Subsection.

**Table A.1 — Analysis of risks associated with flooding**

<b>Hazard</b>	<b>Cause</b>	<b>Likelihood factors</b>	<b>Magnitude factors</b>
Swamping	Caused by entry of water to buoyant spaces via openings above the gunwale, freeboard deck or bulkhead deck	Wave height relative to freeboard Compartments having decks open to the sea. Wells and cockpits	Volume of cockpits and wells Area of cockpits, wells and vehicle decks Drainage of cockpits, wells and vehicle decks
Local flooding	Caused by failure of watertight structures or fittings (such as sea valves, sea water piping, discharges, rudder or stern tube, propeller tail shaft, structural cracking, exhaust discharges); but may also include for the purposes of this Subsection water used to extinguish fires	Number and disposition of seawater systems and shell fittings such as valves, rudders, propellers.	Size of openings relative to total buoyancy Bilge pumping capacity Size of single compartment where breach occurs. Contents of compartment in context of systems essential to safety, or potential danger to persons.
Collision	Caused by contact with other vessels, large marine creatures, port infrastructure (buoys, groins, wharves), submerged containers, etc	Location on vessel Extent of collision damage Area of operation Speed	As per local flooding but also: Relative size of vessels Extent of collision damage (energy = function of speed and mass) Hull material and thickness Area of operation Location of any breach relative to watertight boundaries
Grounding or stranding	Caused by contact with the sea bottom, wrecks and other stationary objects at or below the waterline	Extent of grounding damage Speed Location on vessel	As per local flooding but also: Bottom configuration Hull material and thickness Extent of bottom damage (energy = function of speed and mass) Area of operation Location of breach relative to watertight boundaries

## ANNEX B FUNCTIONAL ANALYSIS OF REQUIREMENTS FOR BUOYANCY AND STABILITY AFTER FLOODING

### B1 SCOPE

Table B.1 lists specific prescriptive requirements and identifies the corresponding primary function, performance requirement and the parameters that determine performance.

This informative Annex is referenced in Clause 2.1 of this Subsection.

**Table B.1 — Function, performance requirement and performance parameters derived from prescriptive requirements**

Requirement	Primary function	Performance requirement	Performance parameters
Collision bulkhead	Reduce the consequences of a bow on collision	<p>1. Control the relatively high risk of bow collision by limiting the extent of direct flooding to the forward most portion of the vessel and thus prevent—</p> <p>a) foundering due to loss of buoyancy through direct flooding or progressive downflooding</p> <p>b) excessive trim by the stem that would endanger safety</p> <p>c) water entry into enclosed spaces above the bulkhead deck that could endanger the stability of the vessel</p> <p>2. Allow the vessel to make port under own power</p>	<p>Likelihood of bow collision.</p> <p>Speed during collision</p> <p>Height of waves</p> <p>Proximity of collision bulkhead to point of impact determines likelihood of bulkhead survival</p> <p>Strength of bulkhead to maintain watertight integrity after a collision and after exposure from hydrostatic and hydrodynamic heads arising from the vessel's return to port</p> <p>Flooded volume of fore peak compartment and its effect on the trim of the vessel</p> <p>Freeboard at the collision bulkhead to prevent progressive downflooding in the static state</p> <p>Minimum bow height after damage if the vessel is to return to port under its own power</p> <p>The effect of excessive trim on rudder &amp; propeller emergence and directional stability</p> <p>Height of bulkhead relative to the bulkhead deck and other enclosed spaces to prevent progressive downflooding</p> <p>Other factors that affect the reliability of the collision bulkhead such as penetrations</p>

Requirement	Primary function	Performance requirement	Performance parameters
Aft peak bulkhead	Reduces the consequences of a loss of watertight integrity the aft end of a vessel	Control the relatively high risk of flooding from a failure of a propeller blade, stern tube or rudder tube by limiting the extent of flooding that can occur to the aft most portion of the vessel to prevent— a) foundering due to loss of buoyancy through direct or progressive downflooding b) excessive trim by the stern that would endanger safety	Likelihood of propeller blade failure Likelihood of stern tube failure Likelihood of rudder tube failure Separation of that portion of vessel containing the stern tube, rudder tube and the hull adjacent to the propeller Flooded volume of aft peak compartment and its effect on the trim of the vessel Strength of bulkhead to maintain watertight integrity once flooded Other factors that affect the reliability of the bulkhead such as bulkhead penetrations
Stern gland and shaft tunnel	Isolates a high risk space from other spaces on the vessel	Control of the relatively high risk of flooding caused by leaking or failure of the stern gland or a fracture of the tail shaft  Allow access to the stern gland, notwithstanding damage to the stern tube that floods the aft peak compartment	Likelihood of tail shaft failure Likelihood of stern gland leaking or failing Separation of that portion of the vessel where the stern gland is located Strength of bulkheads and flats to maintain watertight integrity once flooded Other factors that affect the reliability of the bulkhead such as bulkhead penetrations
Machinery space bulkheads	Isolates a high risk space from other spaces on the vessel.	Control the relatively high risk of flooding in a machinery space due to the number and extent of sea connections and seawater systems  Reduce the effect of flooding in other spaces of the vessel by protecting a space that contains machinery and equipment essential for safety (e.g. bilge pumping, electrical services, propulsion machinery)  Reduce the risk of fire in a space that is normally of high risk by providing a barrier that allows the space to be shut down of oxygen preventing the spread of smoke through the vessel	Likelihood of flooding through seawater systems in engine room Nature of emergency systems contained within machinery space and any redundancy outside the engine room Effective separation of the machinery space from other portions of the vessel Height of bulkhead relative to the bulkhead deck and other enclosed spaces to delay progressive downflooding Strength of bulkhead to maintain watertight integrity once flooded Other factors that affect the reliability of the bulkhead such as bulkhead penetrations

Requirement	Primary function	Performance requirement	Performance parameters
Basic subdivision	Confines flooding to specific portion of vessel.	Prevent loss by capsize and prolong the period before the vessel is lost through loss of buoyancy allowing time to reduce the consequences by— a) damage control and/or b) evacuation	Relative flooded volume and waterplane moment of inertia of individual compartments relative to the total reserve buoyancy and waterplane moment of inertia of the vessel Height of bulkhead relative to the bulkhead deck and other enclosed spaces to delay progressive downflooding Strength of bulkhead to maintain watertight integrity during flooding Other factors that affect the reliability of the bulkhead such as bulkhead penetrations Time needed for damage control and/or evacuation
Double bottom	Confines flooding from bottom damage to a relatively small volume within the lower part of the vessel	Reduce the consequences of damage by grounding or stranding. Provide a local one, two or even more compartment standard of protection for portions of the length of the vessel that would not otherwise meet such standards Protect spaces containing equipment and systems essential to safety Confine lost buoyancy to relatively low location on the vessel, largely eliminating the likelihood of capsize through damage	Likelihood of grounding or stranding Likely location of damage through grounding or stranding Likely extent of damage through grounding or stranding Consequence of breach of one or more compartments on reserve buoyancy of the vessel Strength of double bottom to maintain watertight integrity after flooding Height of double bottom above underside of keel Height of double bottom above bottom shell Other factors that affect the reliability of the double bottom such as penetrations and the presence of wells
One-compartment subdivision (Becomes basic if more than one compartment flooded)	Confines flooding to specific portion of vessel sufficient to avoid progressive downflooding	Reduces the consequences of a vessel flooding by having bulkheads sufficiently closely spaced that if a single compartment floods equilibrium will be reached before progressive downflooding can occur allowing additional time for a) damage control and/or b) evacuation	Likelihood of flooding through collision exceeding one compartment Likelihood of flooding through grounding exceeding one compartment Likelihood of flooding through loss of watertight or weathertight integrity exceeding one compartment Height of waves Location of damaged waterline relative to points of downflooding Height of bulkhead relative to the bulkhead deck and other enclosed spaces to delay progressive downflooding Strength of bulkhead to maintain watertight integrity during flooding Other factors that affect the reliability of the bulkhead such as bulkhead penetrations



Requirement	Primary function	Performance requirement	Performance parameters
<p>One-compartment damage stability (Becomes basic if more than one compartment flooded)</p>	<p>Confines flooding to specific portion of vessel sufficient to maintain stability under specified conditions</p>	<p>Reduces the risk of loss of the vessel by having bulkheads sufficiently closely spaced that if a single compartment floods the vessel will maintain a given minimum level of stability</p>	<p>Likelihood of flooding through collision exceeding one compartment Likelihood of flooding through grounding exceeding one compartment Likelihood of flooding through loss of watertight or weathertight integrity exceeding one compartment Heeling moments including wind, person, evacuation, unsymmetrical flooding Height of waves Angles of heel before points of downflooding are immersed by the damaged waterline Height of bulkhead relative to the bulkhead deck and other enclosed spaces to delay progressive downflooding Strength of bulkhead to maintain watertight integrity during flooding Other factors that affect the reliability of the bulkhead such as bulkhead penetrations Maximum allowable angles for evacuation and the operation of essential systems</p>
<p>Two-compartment subdivision (Becomes basic if more than one compartment flooded)</p>	<p>Confines flooding to specific portion of vessel sufficient to avoid progressive downflooding</p>	<p>Reduces the consequences of a vessel flooding by having bulkheads sufficiently closely spaced that if two compartments flood equilibrium will be reached before progressive downflooding can occur allowing additional time for a) damage control and/or b) evacuation Reduces the risk of loss of the vessel by having bulkheads sufficiently closely spaced that if a single compartment floods the vessel will survive with a relatively high freeboard</p>	<p>Likelihood of flooding through collision exceeding two compartments Likelihood of flooding through grounding exceeding two compartments Likelihood of flooding through loss of watertight or weathertight integrity exceeding two compartments Height of waves Location of damaged waterline relative to points of downflooding Height of bulkhead relative to the bulkhead deck and other enclosed spaces to delay progressive downflooding Strength of bulkhead to maintain watertight integrity during flooding Other factors that affect the reliability of the bulkhead such as bulkhead penetrations</p>

Requirement	Primary function	Performance requirement	Performance parameters
Two-compartment damage stability (Becomes basic if more than one compartment flooded)	Confines flooding to specific portion of vessel sufficient to maintain stability under specified conditions	Reduces the risk of loss of the vessel by having bulkheads sufficiently closely spaced that if two compartments flood the vessel will maintain a given minimum level of stability	<p>Likelihood of flooding through collision exceeding two compartments</p> <p>Likelihood of flooding through grounding exceeding two compartments</p> <p>Likelihood of flooding through loss of watertight or weathertight integrity exceeding two compartments</p> <p>Heeling moments including wind, person, evacuation, unsymmetrical flooding</p> <p>Height of waves</p> <p>Angles of heel before points of downflooding are immersed by the damaged waterline</p> <p>Height of bulkhead relative to the bulkhead deck and other enclosed spaces to delay progressive downflooding</p> <p>Strength of bulkhead to maintain watertight integrity during flooding</p> <p>Other factors that affect the reliability of the bulkhead such as bulkhead penetrations</p>
Basic flotation	Keep the vessel afloat in the event of swamping or capsize	Flotation sufficient to support the boat and a portion of its load in the event that the boat is fully swamped; persons are supported by clinging to the partially submerged boat	<p>Likelihood of quick rescue and proximity of shore</p> <p>Volume of buoyancy media relative to the mass of the boat and fixings</p> <p>Characteristics of buoyancy media to withstand hydrostatic pressure, permeation by sea water</p> <p>Attachment of the buoyancy media to the vessel structure</p> <p>Reliability of the buoyancy media including resistance to solvents, structural degradation over time, vulnerability of air tight chambers to leaking, etc</p> <p>Fire risks associated with material of construction of buoyancy media</p> <p>For vessels where the buoyancy material is in place of a liferaft or buoyancy apparatus, the likelihood of fire on the vessel</p>

Requirement	Primary function	Performance requirement	Performance parameters
Level flotation	<p>Keep the vessel afloat and upright in the event of swamping</p> <p>Keep the vessel afloat in the event of capsize</p>	<p>Flotation sufficient to support the boat and its load level to the water surface in the event that the boat is fully swamped; persons are supported within the partially submerged boat</p> <p>Vessel capable of being drained after swamping and vessel returning to safety under own power (outboards?)</p>	<p>Volume and disposition of buoyancy media relative to the mass of the boat, its fixings and the load of the boat</p> <p>Characteristics of buoyancy media to withstand hydrostatic pressure, permeation by sea water</p> <p>Attachment of the buoyancy media to the vessel structure</p> <p>Reliability of the buoyancy media including resistance to solvents, structural degradation over time, vulnerability of air tight chambers to leaking, etc</p> <p>Fire risks associated with material of construction of buoyancy media</p> <p>For vessels where the buoyancy material is in place of a liferaft or buoyancy apparatus, the likelihood of fire on the vessel</p>

## ANNEX C ADDITIONAL BUOYANCY CALCULATION

### C1 SCOPE

This Annex specifies calculation methods for determining the volume and location of additional buoyancy required for a vessel to satisfy the criteria for basic flotation or level flotation specified in Clauses 8.6 and 8.7 respectively.

This Annex is a normative part of this Subsection.

### C2 APPLICATION

This Annex applies to vessels specified in CHAPTER 3, CHAPTER 4 and CHAPTER 5 that are required to meet the criteria for basic and level flotation.

### C3 OBJECTIVE

The objective of this Annex is to provide a reliable method for calculating the quantity of additional buoyancy required to meet the criteria for basic and level flotation.

### C4 METHOD

A2

#### C4.1 Description

The method has three stages

- a) The swamped weight of the vessel is determined, then
- b) The total weight required to be supported by additional buoyancy when in the swamped condition is established, then
- c) The quantity of additional buoyancy required to support this weight is determined.

NOTE: The method applies units of mass. While not strictly correct for an analysis of weight, this has been done for the convenience of users.

A2

#### C4.2 Total deadweight and its components

For the purposes of the following calculations, the dry deadweight  $W_{Dwt}$  shall comprise the following components:

$$W_{Dwt} = W_P + W_{Fw} + W_{De} + W_{Di}$$

where

- $W_{Dwt}$  = The dry deadweight of the vessel including safety equipment, moveable furniture and soft furnishings, in kg
- $W_P$  = The dry weight of total persons on board, in kg
- $W_{Fw}$  = The dry weight of any fuel or water below the deck or gunwale, in kg
- $W_{De}$  = The dry weight of that portion of the deadweight, excluding passengers but including any fuel or water, that lies above the deck or gunwale, in kg
- $W_{Di}$  = The dry weight of that portion of the deadweight, excluding passengers, fuel or water, that lie below the deck or gunwale, in kg

**A2 | C4.3 Swamped weight of the vessel**

The swamped weight ( $W_s$ ) of the vessel including permanently installed fittings, the engine and engine related equipment, shall be determined as follows.

NOTE: The swamped weight of the vessel should not include Items that are not permanently attached such as soft furnishings, safety equipment, fenders, lifting hatch covers and non-integral furniture.

A2 
$$W_s = \sum_1^n W_{hk} + W_d + 0.69 W_{pf} + 0.75 W_e + k_v \left( \sum_1^n W_h + W_d + W_{pf} + W_e \right)$$

where

$\sum_1^n W_{hk}$  = The swamped weight of those portions of the hull likely to be immersed in the flooded condition (normally assume up to gunwale on small craft), in kilograms

=  $W_1 k_1 + W_2 k_2 + W_3 k_3 + \dots + W_{n-1} k_{n-1} + W_n k_n$

where

$W_1, W_2, \dots, W_n$  = the dry weight of the various materials used in hull construction, in kilograms

$k_1, k_2, \dots, k_n$  = a conversion factor applied to the weight of each piece of hull material ( $W_h$ ), to convert the dry material to an equivalent weight when submerged in fresh water as determined by Table C1

$W_d$  = The dry weight of deck and superstructure not immersed in the flooded condition, in kilograms

A1  $W_{pf}$  = The dry weight of permanent fittings not included in  $W_d$ , in kilograms

$W_e$  = The dry weight of the engine and related equipment as installed, in kilograms

$k_v$  = Factor for the reliability of the verification method

= 0 where the vessel is physically tested for compliance

= 0.03 where the vessel is weighed but not actually tested for compliance

= 0.05 where the vessel is not physically weighed or actually tested for compliance

$\sum_1^n W_h$  = The dry weight of those portions of the hull likely to be immersed in the flooded condition (normally assume up to gunwale on small craft), in kg

=  $W_1 + W_2 + W_3 + \dots + W_{n-1} + W_n$

**A2 | C4.4 Total weight required to be supported by additional buoyancy when in the swamped condition**

The total weight ( $W_B$ ) required to be supported by additional buoyancy shall be determined as follows:

$$W_F = W_S + k_{De} W_{De} + k_P W_P + 0.25 W_{Di}$$

where

- $W_F$  = The total weight required to be supported by additional buoyancy, in kg
- $W_S$  = The swamped weight of the vessel from Clause C4.2, in kg
- $k_{De}$  = The deadweight support factor  
 = 0.25 for basic flotation  
 = 1.00 for level flotation
- $W_{De}$  = The dry weight of that portion of the deadweight, excluding persons but including any fuel or water, that lies above the deck or gunwale, in kg
- $k_P$  = Person support factor  
 = 0.1 for basic flotation  
 = 0.5 for level flotation on an open, collared or well-deck vessel  
 = 1.0 for level flotation on a decked vessel
- $W_P$  = The dry weight of total persons on board, in kg  
 =  $N \times w$   
 where  
 $N$  = The maximum number of persons on board the vessel  
 $w$  = The assumed weight of each person on the vessel, in kg  
 = 80 kg
- $W_{Di}$  = The dry weight of that portion of the deadweight, excluding persons but including any fuel or water, that lies below the deck or gunwale, in kg

## A2 | C4.5

### Volume of additional buoyancy

The volume of additional buoyant ( $V_b$ ) shall be determined as follows:

$$V_b = k_f k_{pf} \frac{W_F}{1000 - w_b} + V_{ac}$$

where

- $V_b$  = The minimum required volume of additional buoyancy, in  $m^3$
- $k_f$  = Factor to allow for a degree of shrinkage including pressure, chemical or other effects  
 = 1.05
- $k_{pf}$  = Factor for the variability of poured foam  
 = 1.1 where poured foam is used, and the density and/or volume of the foam cannot be accurately verified, and the vessel is not physically tested for compliance.  
 = 1.0 otherwise
- $W_F$  = The total weight required to be supported by additional

buoyancy calculated in Clause C4.4 , in kg

$w_b$  = The dry weight of 1 m<sup>3</sup> of additional buoyancy used, in kg  
 = For non-integral buoyancy chambers; the average weight obtained by dividing the total weight of chambers by the total volume of chambers, in kg

$V_{ac}$  = For collared vessels with inflated collars: The volume of the largest air chamber (excluding damaged chambers as specified in Clauses 7.3.7., 7.4.5, or 7.5 applicable for the particular condition being analysed), in m<sup>3</sup>  
 = For other vessels: The volume of the two largest air chambers, in m<sup>3</sup>

**Table C.1 — Factor  $k$  applicable to various materials**

Material	Relative density	Factor ( $k$ )	Material	Relative density	Factor ( $k$ )
Lead	11.38	0.91	Tallow-wood	0.99	-0.01
Copper	8.91	0.89	Spotted gum	0.95	-0.05
Monel Metal	8.91	0.89	High density polyethylene	0.945	-0.06
Bronze	8.88	0.89	Karri	0.90	-0.11
Nickel	8.61	0.88	Red River Gum	0.90	-0.11
Brass	8.56	0.88	Jarrah	0.82	-0.22
Stainless Steel	8.00	0.88	Silver Ash	0.67	-0.49
Steel	7.85	0.88	Pine – Celery Top	0.65	-0.54
Cast Iron	7.08	0.86	Queensland Maple	0.60	-0.67
Zinc-Cast Alloy	6.63	0.85	Blandex-Particle Board	0.58	-0.70
Aluminium	2.73	0.63	Mahogany-Honduras	0.56	-0.78
Glass	2.60	0.62	Fir Plywood	0.55	-0.81
Ferro-Cement	2.40	0.58	Mahogany-Plywood	0.54	-0.83
Rubber	1.51	0.34	Douglas Fir / Oregon	0.53	-0.89
Fibreglass-Laminate	1.50	0.33	Pine – Huon	0.52	-0.92
Kevlar-Laminate	1.30	0.24	White beech	0.50	-1.00
Plexiglass-Lucite	1.20	0.17	Pine – King William	0.40	-1.50
A.B.S. Plastic	1.12	0.11	Cork	0.24	-3.17
Iron Bark	1.12	0.11	Balsa	0.16	-5.24
Teak	0.99	-0.01			

NOTE:

The factor  $k$  can be calculated for any material of known relative density as follows:

$$k = \frac{(\text{Relative density} - 1)}{\text{Relative density}}$$

NOTE: For the purposes of this table, the density of water in which the vessel floats has been assumed to be 1000 kg/m<sup>3</sup>.

## ANNEX D GUIDANCE ON THE DISTRIBUTION OF ADDITIONAL BUOYANCY TO ACHIEVE LEVEL FLOTATION

### D1 SCOPE

This Annex provides guidance on the distribution of additional buoyancy to achieve level flotation.

The Annex is referenced in Clause 8.7.5 and is an informative part of this Subsection.

### D2 APPLICATION

This Annex applies to vessels of measured length less than 7.5 m that are required in CHAPTER 3, CHAPTER 4 or CHAPTER 5 to meet the criteria for level flotation.

### D3 OBJECTIVE

The objective of this Annex is to provide a guide for the distribution of additional buoyancy required to comply with the criteria for level flotation in Clause 8.7.

NOTE: Refer to Annex C to determine the quantity of additional buoyancy.

### D4 GENERAL DESCRIPTION

To achieve level flotation—

- a) additional buoyancy should be located as high in the vessel as possible
- b) a significant proportion of the additional buoyancy should be located along the sides of the vessel in way of and above the loaded flooded waterline
- c) additional buoyancy should not be installed in way of the keel or bottom of the vessel
- d) the keel or bottom of the vessel should be arranged to allow water to quickly fill the space without unsymmetrical flooding effects.

### D5 QUANTITY OF ADDITIONAL BUOYANCY IN THE SIDES OF THE VESSEL

The total additional quantity of buoyancy in each side of the vessel at or above the flooded waterline should not be less than:

$$V_S = \frac{0.125 W_P}{1000 - w_b}$$

where

$V_S$  = The total additional quantity of buoyancy in each side of the vessel at or above the flooded waterline, in m<sup>3</sup>

$W_P$  = The maximum total weight of persons on board, in kg

=  $N \times w$



where

$N$  = The maximum number of persons on board the vessel

$w$  = The assumed weight of each person on the vessel, in kg

= 80 kg

$w_b$  = The weight of 1 m<sup>3</sup> of buoyant material used, in kg

= For non-integral buoyancy chambers; the average weight obtained by dividing the total weight of chambers by the total volume of chambers, in kg

NOTE: There is no guarantee that a vessel fitted with air chambers will comply with level flotation criteria should one or more chambers leak; however, the vessel will continue to comply with basic flotation criteria.

## D6 QUANTITY OF ADDITIONAL BUOYANCY IN THE ENDS OF THE VESSEL

The total quantity of additional buoyancy in each end of a vessel fitted with an outboard or sterndrive should not be less than:

$$V_f = 0.25 V_b \text{ and}$$

$$V_a = 0.5 V_b$$

where

$V_f$  = The quantity of additional buoyancy located in the forward 30 per cent of the person carrying area, in m<sup>3</sup>

$V_a$  = The quantity of additional buoyancy located in the aft 30 per cent of the vessel, in m<sup>3</sup>

$V_b$  = The minimum required volume of buoyant material for level flotation calculated in Clause 0, in m<sup>3</sup>

## ANNEX E TEST PROCEDURE FOR LEVEL FLOTATION

### E1 SCOPE

This Annex specifies a procedure for testing a vessel's compliance with the level flotation criteria of this Subsection.

The Annex is a normative part of this Subsection.

### E2 APPLICATION

This Annex applies to vessels required to meet the criteria for level flotation specified in Clause 8.7. It is suited to vessel of length 7.5 m or less but may be applied to larger vessels of simple configuration.

The Annex is referenced in Clauses 4.6 and 8.7.5.

### E3 OBJECTIVE

The objective of this Annex is to provide a reliable, relatively low-cost method of verifying compliance with the level flotation criteria that does not require complex calculation.

### E4 EQUIPMENT

#### E4.1 Application

The equipment used in the test procedure to verify compliance with level flotation is listed in Table E.1.

**Table E.1 — Requirements for equipment**

Requirement	Reference
The vessel	Clause E4.2
Weights to simulate swamped conditions	Clause E4.3
Means for measuring angles of inclination	
Means for reading freeboards and reference drafts without affecting the attitude of the vessel in its simulated swamped condition	
Means for recording results	

#### E4.2 The vessel

The vessel shall be complete with every permanently installed fitting such as windshields and convertible tops, secured in place. The vessel shall be prepared as follows:

- a) Permanent fuel tanks shall be filled with fuel and sealed.
- b) Water and holding tanks shall be filled with fresh water.

#### E4.3 Weights to simulate swamped conditions

A sufficient quantity of weights shall be obtained to simulate weights on the vessel as specified in Table E.2.

NOTE: Dense materials such as lead, steel or iron are frequently used to simulate weights.

**Table E.2 — Simulated weights for level flotation**

<b>Group</b>	<b>Description</b>
$W_1$	= 50% of the weight of persons if the vessel is an open vessel, a well deck vessel or a collared vessel; or
	= 100% of the weight of persons if the vessel is a decked vessel
$W_2$	= 25% of the difference between maximum load and the sum of the weights of persons, fuel and water;
$W_3$	= 75% of the weight of the engine and battery and other machinery components

**E5 PREPARATION**

The vessel shall be prepared as follows—

- a) The weights  $W_1$ , and  $W_2$  shall be placed so that their centre of gravity lies at the centre of the person-carrying area (Figure E.1a) as shown in Figure E.1b.
- b) The weights  $W_3$  shall be placed as close as practicable to the position of those components they replace.
- c) All compartments integral with the hull not being intact watertight compartments (see CHAPTER 4 and CHAPTER 5) or designated air chambers (see CHAPTER 10) shall be flooded so that no trapped air remains in the hull, and water is free to flow in and out of the hull.
- d) Where air chambers are part of the flotation, the number of such chambers specified in Clause 8.7 shall be perforated so as to allow complete flooding.
- e) The vessel shall be flooded for a period of not less than 18 hours.

**E6 EXPERIMENTAL PROCEDURE****E6.1 Overview**

The vessel shall be tested in three separate conditions of loading—

- a) the symmetrical fully-laden condition,
- b) the unsymmetrical partially-laden condition, and
- c) the symmetrical light condition.

**E6.2 Symmetrical fully-laden condition**

With the vessel laden as described in Clause E5:

- a) The vessel shall be inspected to confirm that at least one point of either the forward or aft reference area is above the surface of the water;
- b) The least draft of the immersed reference area shall be measured at the centre line; and
- c) The results shall be compared against the criteria in Table 33

If the vessel fails to meet the criteria, the test shall be suspended.

**E6.3 Unsymmetrical partially-laden condition**

With the vessel laden as described in Clause E5:

- d) Half the swamped weight of persons ( $W_1/2$ ) shall be removed from the vessel;
- e) The second half of the swamped weight of persons ( $W_1/2$ ) shall be shifted outboard within the middle 70% of the length of the person carrying area, see Figure E.1c;
- f) The vessel shall be inspected to confirm that at least one point of either the forward or aft reference area is above the surface of the water;
- g) The least draft of the immersed reference area shall be measured at the centre line;
- h) The angle of heel of the vessel shall be measured; and
- i) The results shall be compared against the criteria in Table 34.

If the vessel fails to meet the criteria, the test shall be suspended.

#### **E6.4 Symmetrical light condition**

With the vessel laden as described in Clause E6.3:

- a) The unsymmetrical swamped weight of persons ( $W_1/2$ ) shall be removed;
- b) The weight  $W_1$  shall be removed from the vessel;
- c) The vessel shall be inspected to confirm that at least one point of either the forward or aft reference area is above the surface of the water;
- d) The least draft of the immersed reference area shall be measured at the centre line;
- e) The results shall be compared against the criteria in Table 35.

If the vessel fails to meet the criteria, the test shall be suspended.

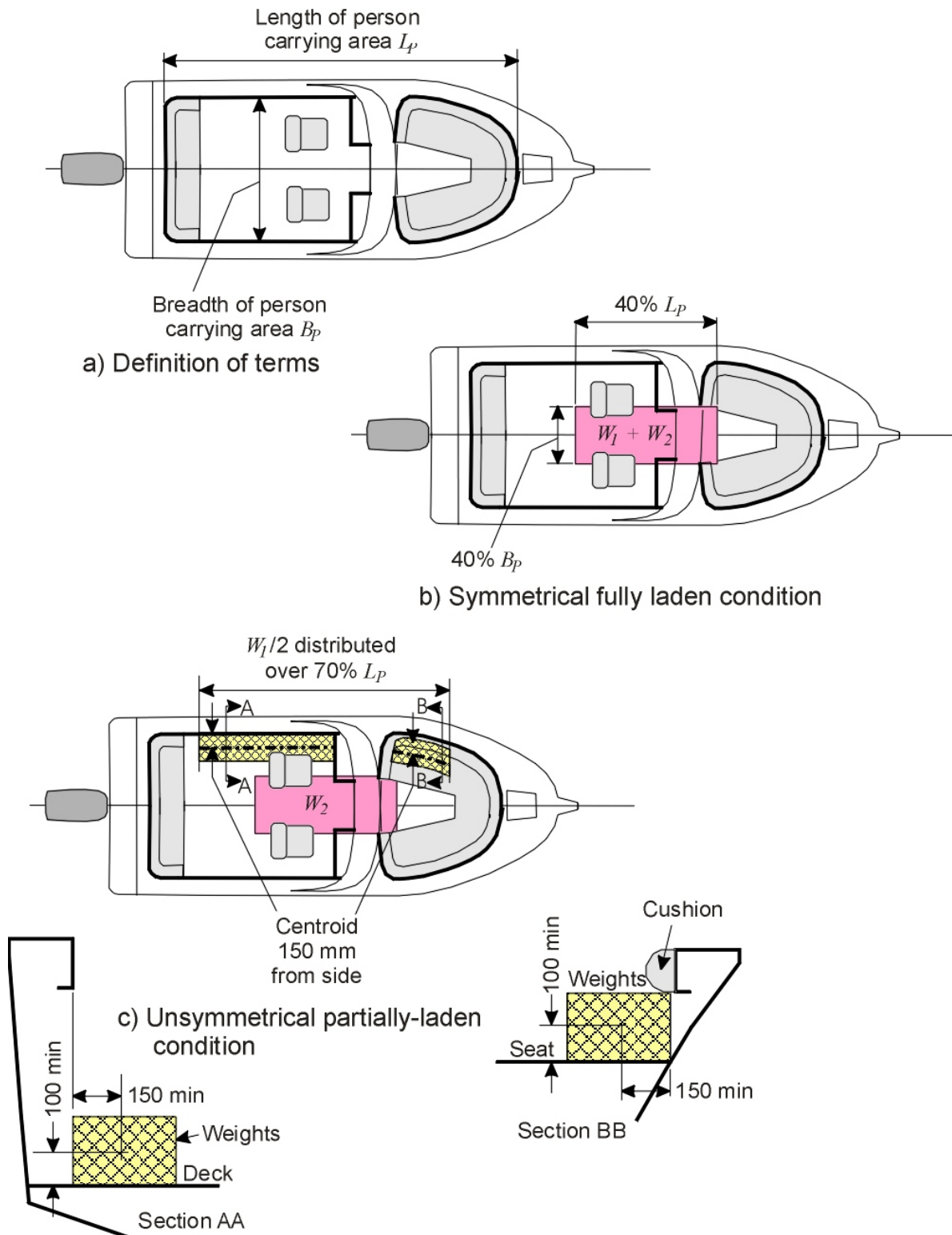

Figure E.1 — Location of weights on vessel during level flotation test

## ANNEX F TESTS FOR LOW-DENSITY FLOTATION MATERIALS

### F1 SCOPE

This Annex specifies the deemed-to-satisfy specification for low-density flotation material intended to provide buoyancy for vessels in compliance with this section.

The Annex is a normative part of this Subsection.

EXAMPLE:

Rigid closed-cell foam materials

### F2 APPLICATION

This Annex applies to low-density flotation material installed to provide basic flotation (Clause 8.6), level flotation (Clause 8.7) or compliance with the comprehensive damaged stability criteria specified in Clauses 8.4 and/or 8.5.

The Annex is referenced in Clause 10.3.2.2.

### F3 OBJECTIVE

The objective of this Annex is to ensure that low-density flotation material that has been installed to provide buoyancy at time of need will perform as intended in the event that the vessel is flooded.

### F4 REQUIRED MATERIAL PROPERTIES AND RELEVANT TEST STANDARDS

#### F4.1 Resistance to hydrostatic pressure

Low-density flotation materials shall be resistant to the effects of hydrostatic pressure that might be encountered during flooding. The compressive strength in kPa at 10 per cent strain shall not be less than the greater of

$$95 T_f \text{ or } 235 \text{ kPa}$$

where

$$T_f = \text{Depth of water to the lowest point of the low-density flotation material in the flooded condition, in m}$$

NOTES:

1. The depth of water will likely be similar to the distance from the lowest point of the low-density flotation material to the gunwale on vessels with level flotation, but may be as much as the length of the vessel beneath the water on vessels with basic flotation.
2. Material of compressive strength less than that specified may be considered as proposal for an equivalent solution where additional volume is provided that compensates for the effects of hydrostatic pressure on the effective buoyancy.

The material shall be subject to a submergence test at the depth  $T_f$  for a period of not less than 7 days to confirm that the material has sufficient strength to withstand a hydrostatic head. The resulting density after the submergence test, if different from the initial density, shall be used to

modify the relative density of the flotation material for use in applying the criteria specified in CHAPTER 8 and, where applicable, Annex C.

Materials that comply with the compressive strength requirements of the relevant standards listed in Table F.1 shall be deemed-to-satisfy the requirements of this Clause, to the extent specified within the Table.

#### F4.2 Stability under temperature cycling

Low-density flotation materials shall be resistant to the effects of changes of temperature during normal operation. Materials that comply with the relevant standards for stability under temperature cycling listed in Table F.1 shall be deemed-to-satisfy the requirements of this Clause.

**Table F.1 — Deemed-to-satisfy standards for low-density flotation materials**

Standard	Resistance to hydrostatic pressure (Clause F4.1)	Stability under temperature cycling (Clause F4.2)	Water absorption (Clause F4.3)	Resistance to hydrocarbons (Clause F4.4)	Resistance to bilge cleaner (for LDFM A only Clause F4.4)
IMO Resolution MSC.81(70) (see note 1)	DtS for depths ( $T_f$ ) up to 0.75 m	DtS	DtS for depths ( $T_f$ ) up to 0.75 m	DtS for LDFM B and LDFM C applications (see Table F.2) ☒ for LDFM A	☒
MIL-P-21929C	DtS for depths ( $T_f$ ) up to 2.4 m	DtS	DtS for depths ( $T_f$ ) up to 2.4 m	DtS for LDFM B and LDFM C applications (see Table F.2) ☒ for LDFM A	☒
MIL-P-21929B	DtS for depths ( $T_f$ ) up to 4.3 m	DtS	DtS for depths ( $T_f$ ) up to 4.3 m	DtS for LDFM B and LDFM C applications (see Table F.2) ☒ for LDFM A	☒

KEY:

3. Includes requirements for low-density materials in ISO 12217-1 Annex F and ISO 12217-3 Annex C where the material complies with IMO Resolution MSC.81(70).

DtS Deemed-to-satisfy

☒ Test required to be deemed-to-satisfy

#### F4.3 Resistance to water absorption

Low-density flotation materials shall be resistant to water absorption when immersed. Materials that comply with the relevant standards for resistance to water absorption listed in Table F.1 shall be deemed-to-satisfy the requirements of this Clause.

#### F4.4 Resistance to hydrocarbons and bilge cleaner

Low-density flotation materials shall have a resistance to hydrocarbons and bilge cleaner appropriate to the risks of exposure to such substances. Three classes of low-density flotation materials are defined: LDFM A, LDFM B and LDFM C, as listed in Table F.2. Materials that comply with the

specified standards listed in Table F.1 shall be deemed-to-satisfy the requirements of this Clause to the extent specified in Table F.1.

**Table F.2 — Low-density flotation material resistance tests**

Description	Test	Class of flotation material		
		LDFM A	LDFM B	LDFM C
Exposure to hydrocarbon vapours	The flotation material shall not reduce in buoyant volume by more than 5% after being immersed in a fully saturated petrol vapour atmosphere for the time specified at not less than 38°C. No sign of damage or deterioration should be observed	Not required	Not required	30 days
Immersion in petrol	The flotation material shall not reduce in buoyant volume by more than 5% after being immersed for the time specified at 23°C ± 2°C in reference fuel B (1). . No sign of damage or deterioration should be observed	30 days	24 hours	Not required
Immersion in oil	The flotation material shall not reduce in buoyant volume by more than 5% after being immersed for the time specified at 23°C ± 2°C in No. 2 reference oil (1). . No sign of damage or deterioration should be observed	30 days	24 hours	Not required
Immersion in bilge cleaner	The flotation material shall not reduce in buoyant volume by more than 5% after being immersed for the time specified at 23°C ± 2°C in a 5% solution of trisodium phosphate in water. . No sign of damage or deterioration should be observed	30 days	Not required	Not required

KEY:

(1) Refer to ASTM D 471-96 for specifications of reference liquids.



## ANNEX G WARNING SYMBOLS

### G1 SCOPE

This Annex specifies warning symbols.

The Annex is a normative part of this Subsection.

### G2 APPLICATION

This Annex is referenced in Clause 9.5.

### G3 OBJECTIVE

The objective of this Annex is to provide a standard means of providing information essential to the safety of the vessel.

### G4 WATERTIGHT BOUNDARIES

Internal boundaries that are assumed watertight for the purposes of compliance with the criteria contained within this subsection shall be marked in at least one location on each side of the bulkhead by a warning symbol as shown in Figure G.1.

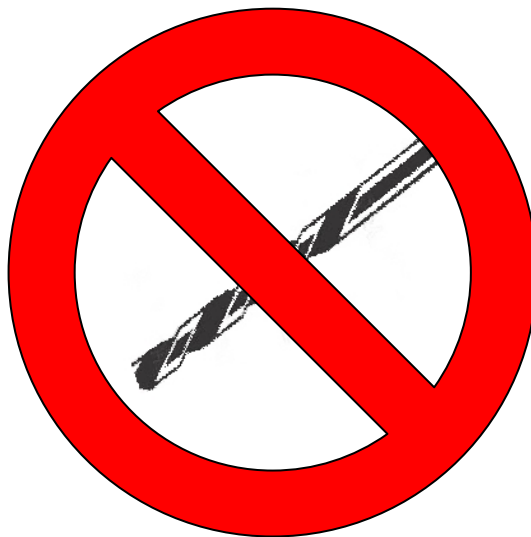

Figure G.1 — Do not penetrate bulkhead sign

## ANNEX H      GUIDELINES FOR PROCEDURES OF TESTING WATERTIGHT BOUNDARIES

### H1      SCOPE

These test procedures are to verify the watertightness of watertight boundaries and structural adequacy of tanks.

This Annex is informative.

### H2      APPLICATION

This Annex applies to watertight boundaries of spaces. It is referenced in Clause 9.9.

The tests apply to the—

- a) boundaries of gravity tanks and chain lockers — for their tightness and structural adequacy, and
- b) watertight boundaries other than those of gravity tanks and chain lockers — for their watertightness.

NOTE: Gravity tank means a tank that is subject to vapour pressure not greater than 70 kPa.

### H3      TEST PROCEDURES

#### H3.1 State of completion

Tests should be carried out at a stage sufficiently close to the completion of the work with all hatches, doors, windows, etc., installed and all penetrations including pipe connections fitted, and before any ceiling and cement work is applied over the joints.

NOTE: Legislation may require that the tests be witnessed in the presence of a Surveyor.

### H4      STRUCTURAL TEST

#### H4.1 Application

A structural test is applied to verify the structural adequacy of the construction of tanks and chain lockers.

#### H4.2 Testing methods

Testing methods for undertaking structural tests are listed in Table H.1. A hydropneumatic test should not be used except where—

- a) the hydrostatic test is not possible because of practical limitations in the support of the vessel or strength of the building berth; or
- b) the tank is intended for cargoes with higher density, and the tank is to be tested with fresh water or sea water.

#### H4.3 Testing afloat

A hydrostatic test for structural adequacy of a watertight division may be undertaken with the vessel afloat, subject to the results of a leak test having already been found satisfactory.

## **H4.4 Number of tanks to be tested**

### **H4.4.1 Sampling**

Structural tests need only be undertaken on a representative sample of tanks; taking into account the similarity of loading, design, construction and workmanship. Tanks should be selected so that all representative structural members are tested for the expected tension and compression. Tanks that have not been subjected to a structural test should be tested for leaks by an air test.

NOTE: Additional tanks may require structural test if found necessary after the structural testing of the sample tank(s) or if doubts remain after visual inspection and/or leak testing.

### **H4.4.2 Sister vessels**

Structural tests need not be undertaken on the tanks of subsequent sister vessels taking into account the extent to which the loading, design, construction and workmanship of the sister vessel is similar to those of the prototype vessel. For the purposes of this clause, a vessel built at a different shipyard or built at the same shipyard after a lengthy break in production of the series should not be considered a sister vessel. The tanks of sister vessels that have not been subjected to a structural test shall be tested for leaks by an air test.

## **H5 LEAK TEST**

### **H5.1 Application**

A leak test are applied to verify the tightness of the boundary.

### **H5.2 Testing methods**

Testing methods for undertaking leak tests are listed in Table H.1.

### **H5.3 Hierarchy of test method reliability**

Leak testing by hydrostatic test, hydropneumatic test, or air test should be preferred because of their greater reliability.

Where such tests are not practical because of difficulties containing fluid, possible damage to the vessel, machinery, electrical equipment insulation or outfitting items, they may be replaced by a hose test, tank air test, compressed air fillet weld test or vacuum box test. A compressed air fillet weld test may be carried out in the block stage provided all work of the block that may affect the tightness of the joint is completed before the test.

In those locations where the above-listed tests are still not practical, they may be replaced by a careful visual examination of welded connections, supported where necessary by means such as a dye penetrant test or ultrasonic leak test.

### **H5.4 Coatings**

#### **H5.4.1 General**

Measures should be taken to ensure that surface coatings do not hinder the reliability of leak test results.

**H5.4.2 Final coating**

For butt joints by automatic process, final coating may be applied anytime before completion of leak test of the space bounded by the joint.

For all other joints, final coating should be applied after the completion of leak test of the joint.

**H5.4.3 Temporary coating**

Shop primer may be applied at any time. Any other temporary coating which could conceal defects or leaks should be applied at a time as specified for final coating.

Table H.1 — Test methods for watertight boundaries

Testing method	Test type	Description	Details of tests
Hydrostatic test	Structural or leak	The space is filled with a liquid to specified head.	The hydrostatic test consists of filling the space by fresh water or sea water, whichever is appropriate for testing of the space, to the level specified in Table 1 or Table 2.
Hydropneumatic test	Structural or leak	The space is partially filled with liquid and air pressure is applied on top of the liquid surface to achieve the specified head.	The hydropneumatic test should be such that the test condition in conjunction with the approved liquid level and air pressure will simulate the actual loading as far as practicable. The requirements and recommendations for tank air tests below should also apply to hydropneumatic test.
Hose test	Leak	A jet of water from a hose is used to verify the tightness of a joint.	Hose test should be carried out with the pressure in the hose nozzle maintained at least at 200 kPa during the test. The nozzle should have a minimum inside diameter of 12 mm and be at a distance to the joint not exceeding 1.5 m.
Air test	Leak	A pressure differential is created by means of air pressure (1). Leak detection solution is applied verify the tightness of a boundary.	The boundary welds, erection joints and penetrations including pipe connections are examined with a leak indication solution applied under a pressure differential above atmosphere pressure not less than 15 kPa. It is recommended that the air pressure in the tank be raised to and maintained at about 20 kPa for approximately one hour, with a minimum number of personnel around the tank, before lowered to the test pressure of 15 kPa. A U-tube should be provided having a height sufficient to hold a head of water corresponding to the required test pressure. The cross sectional area of the U-tube should be not less than that of the pipe supplying air to the tank. In addition to U-tube, a master gauge or other reliable means to verify the pressure should be provided.

Testing method	Test type	Description	Details of tests
Compressed air test for fillet welds	Leak	A leak indicating solution is applied onto a fillet welded tee joint and leaks are detected by measuring any drop in pressure of compressed air injected into the joint between the fillet welds.	Compressed air is injected from one end of fillet welded joint and the pressure verified at the other end of joint by a pressure gauge on the opposite side. Pressure gauges should be arranged so that an air pressure of at least 15 kPa can be verified at each end of all passages within the portion being tested.
Vacuum box test	Leak	A vacuum is created within a box placed over fillet or butt welds and a leak indicating solution applied onto the fillet or butt welds.	A box (vacuum tester) with air connections, gauges and inspection window is placed over the joint with leak indicator applied. The air within the box is removed by an ejector to create a vacuum of -20 kPa to -26 kPa inside the box.
Ultrasonic test	Leak	Ultrasonic testing techniques are applied to verify the tightness of the boundary.	An arrangement of an ultrasonic echoes sender inside of a compartment and a receiver outside. A location where the sound is detectable by the receiver displays a leakage in the sealing of the compartment.
Penetration test	Leak	A low surface tension liquid is applied to verify that no continuous leakages exist in the boundaries of a compartment.	A test of butt welds using of a low surface tension liquid applied at one side of a compartment boundary. Tightness of the weld is verified if no liquid is detected on the opposite sides of the boundary after expiration of a specified period of time.

KEY:

(1) Examples include filling a tank with air under pressure and creating a vacuum within a tank.

## ANNEX J INFORMATION ON BUOYANCY AND STABILITY AFTER FLOODING – PROPOSED AMENDMENT TO NSCV PART C SUBSECTION 6C.

### J1 SCOPE

This Chapter specifies the minimum deemed-to-satisfy requirements for information on buoyancy and stability after flooding.

### J2 APPLICATION

The provisions of this Chapter shall apply to all vessels required to have stability documentation in accordance with NSCV Part C Subsection 6C.

### J3 INFORMATION TO BE INCLUDED IN THE STABILITY DOCUMENTATION OR OPERATING MANUAL

#### J3.1 Information to be aimed at competence of user

Information essential for safety relevant to buoyancy and stability after flooding shall be provided to the operator. The information shall be kept concise and in a form readily understood by persons having competencies corresponding to the minimum levels prescribed by Part D of this standard.

NOTE: Where a vessel has features that require competencies beyond that provided by compliance with the minimum standards, these shall be highlighted with a requirement that appropriate training be provided.

#### J3.2 Removal of water from spaces within the vessel

The operator shall be provided with information that identifies—

- a) the spaces in which water can collect;
- b) the means by which the presence and quantity of water is to be ascertained; and
- c) the means by which water which has leaked into the space is to be removed.

#### J3.3 Standard of buoyancy and stability after flooding

The operator shall be provided with a description in general terms of the standard of buoyancy and stability after flooding that applies to the vessel, together with a commentary on the limitations of the safety outcomes that arise from such a standard. The damage stability information shall provide the operator with a simple and easily understandable way of—

- a) Identifying the worst-case loading conditions with respect to flooding;
- b) assessing whether the vessel's actual loading condition is no more severe with regard to reserve buoyancy, stability and trim than those used for assessment of the vessel's buoyancy and stability after flooding, and
- c) assessing the vessel's survivability in all flooding cases involving a compartment or group of compartments.

NOTE: Limiting  $KG_f$  and damaged stability computers can be of assistance for providing ready information.

### **J3.4 Loading conditions critical to buoyancy and stability after flooding**

The operator shall be provided with information that—

- a) specifies which, if any, of the loading conditions presented for intact stability in Part F Subsection 6C represent limiting conditions for compliance with the criteria for buoyancy and stability after flooding; and
- b) indicates whether compliance with the criteria for buoyancy and stability after flooding is the limiting condition for assignment of the load line in Part F Section 2.

### **J3.5 Location, operational status and emergency operation of essential components and machinery**

The operator shall be provided with information on the location and use of weathertight and watertight closing appliances, watertight bulkheads, watertight doors, foam buoyancy, air chambers and, where applicable, any cross-flooding fittings, etc. The information shall specify the normal operational status and the operation in emergency circumstances. Any watertight doors permitted to remain open during navigation shall be clearly indicated.

NOTE: Part of this information may be incorporated into the Damage Control Plan specified in Clause J4.

### **J3.6 Vessels with inflated collars**

For vessels with inflated collars, the operator shall be provided with procedures describing—

- a) the method of inflation of collars;
- b) the required working inflation pressure and the means for measuring pressure;
- c) ongoing care and maintenance of the inflated collar;
- d) actions to be taken in the event of chambers losing pressure; and
- e) the repair procedure for collars.

## **J4 DAMAGE CONTROL PLAN**

For vessels of measured length 24 m or more, or vessels of Flooding Risk Category III or IV, a damage control plan shall be permanently exhibited in the main operating compartment showing clearly for each deck and hold the boundaries of the watertight compartments, the openings in those compartments, the means of closure and where relevant the arrangements for the correction of any list due to flooding<sup>1</sup>.

NOTE: For vessels of measured length less than 35 m, the separate Damage Control Plan under this Clause and the Fire Control Plan specified in Part C Section 4 may be combined into a single Emergency Plan.

---

<sup>1</sup> Refer to the IMO Guidelines for damage control plans (MSC/Circ.919).



**J5 COMPLIANCE REPORT**

The vessel's compliance with the requirements of this subsection shall be documented in a compliance report for reference by Marine Authorities and other stakeholders responsible for the safety of the vessel.

NOTE: Detailed calculations or computer program output showing compliance with the criteria contained within this Subsection should not normally be included in documentation intended for use by the operators of the vessel as they are unlikely to have the competencies required to interpret and apply the information.