

Australian Transport Council

**National Standard**  
**for**  
**Commercial Vessels**

**PART B**  
**GENERAL REQUIREMENTS**

Edition 1

Draft for public comment issued — 22 December 2000

Endorsed by the Australian Transport Council — July 2002

First Published — August 2002 (on CD)

Second Publication — April 2005 (on CD)

Correction Amendment 1: April 2011

Edition 1.1, incorporating Amendment 1,

First published: April 2011

© Commonwealth of Australia

This work is copyright. Apart from any use as permitted under the *Copyright Act 1968*, no part may be reproduced by any process without written permission of the CEO, NMSC Inc..

Published by The National Marine Safety Committee Inc, Level 5, 9-15 Young Street, Sydney NSW 2000. All inquiries to be addressed to the Chief Executive Officer, NMSC Inc.

ISBN 978-0-642-73678-9

## FOREWORD

Part B of the National Standard for Commercial Vessels replaces Section 1 of the Uniform Shipping Laws (USL) Code. It has been prepared by the National Marine Safety Committee (NMSC) in consultation with a reference group comprising government and industry representatives.

This Part was workshopped in June 2000 by NMSC members and members of the NMSC's Industry Advisory Panel. Following this workshop, the Part was revised with the draft document and accompanying Regulatory Impact Statement (RIS) being released for public comment on 22 December 2000. Public comment on this Part was received until April 2001. A reference group comprising industry and government met in May 2001 to review the public comment and provide recommendations to the NMSC. The NMSC accepted most of the recommendations of the working group on 30 May 2001 and the draft Subsection and RIS were revised accordingly.

NMSC approved this version of the Subsection in February 2002, with the Office of Regulation Review providing an assessment of the final RIS in March 2002. The Australian Transport Council (ATC) endorsed the document in July 2002.

This standard was first published in August 2002 on CD, and again in April 2005 on CD. There were no amendments between the first and second publication.

Edition 1 was later subject to a correction amendment. Amendment 1 to Clause 1.8 was endorsed by NMSC on 22 March 2011 and published in April 2011.

## CONTENTS OF PART B

CHAPTER 1	PRELIMINARY .....	7
	1.1 Scope .....	7
	1.2 Application .....	7
	1.3 Overall objectives of Parts B to F .....	7
	1.4 Objective of Part B.....	8
	1.5 Transitional arrangements.....	8
	1.6 Referenced documents .....	8
	1.7 Terminology.....	9
	1.8 Definitions.....	9
	1.9 Abbreviations.....	21
	1.10 National Marine Guidance Manual .....	21
CHAPTER 2	USE OF PARTS B TO F OF THE NATIONAL STANDARD.....	22
	2.1 Scope .....	22
	2.2 Objective.....	22
	2.3 Structure of the National Standard for Commercial Vessels .....	22
	Required outcomes.....	24
	2.4 Level of safety .....	24
	2.5 Basis of solutions.....	24
	2.6 Documentation .....	24
	Deemed-to-satisfy solutions.....	24
	2.7 Compliance.....	24
	2.8 Materials, fittings, equipment and workmanship.....	27
CHAPTER 3	CATEGORIES OF VESSELS.....	29
	3.1 Scope .....	29
	3.2 Objective.....	29
	3.3 Vessel use categories .....	29
	3.4 Operational area categories .....	29
	3.5 Service categories .....	31
	3.6 Special service notation.....	32
	3.7 Multiple service categories .....	33

	3.8	Minimum length of seagoing passenger vessels .....	33
	3.9	Limitations on the use of open vessels at sea .....	33
	3.10	Design environmental parameters for equivalent solutions .....	33
ANNEX A		METHODS FOR ESTABLISHING MEASURED LENGTH .....	35
	A1	Scope .....	35
	A2	Objective .....	35
	A3	Application .....	35
	A4	Terminology .....	35
	A5	Illustrations .....	37
	A6	Methods for measuring .....	37
	A7	Unusual vessels .....	38
ANNEX B		GUIDELINES FOR HAZARD IDENTIFICATION, RISK ASSESSMENT AND CONTROL OF RISK .....	50
	B1	Scope .....	50
	B2	Application .....	50
	B3	Hazard identification .....	50
	B4	Risk assessment .....	51
	B5	Control of risk .....	52
	B6	Recommended format for documenting hazards, risks and options for controlling risk .....	54
ANNEX C		GUIDANCE ON ACCEPTABLE RISK .....	57
	C1	Scope .....	57
	C2	Application .....	57
	C3	Desired outcome .....	57
	C4	Nature of risk .....	57
	C5	Likelihood .....	57
	C6	Consequence .....	58
	C7	Acceptable and unacceptable levels of risk .....	59
	C8	Example .....	60
ANNEX D		GUIDANCE ON THE PREPARATION OF INFORMATION AND PLANS FOR VESSELS .....	62
	D1	Scope .....	62
	D2	Application .....	62
	D3	Preliminary information .....	62

D4 Information and plans ..... 63

## CHAPTER 1 PRELIMINARY

### 1.1 SCOPE

Part B of the National Standard for Commercial Vessels specifies how the National Standard for Commercial Vessels is to be used and applied. It includes definitions common to all Parts of the National Standard, as well as establishes a framework for the application of the National Standard. All other Parts of this National Standard shall be read in conjunction with this Part.

Part B should be read in conjunction with Part A of the National Standard for Commercial Vessels.

### 1.2 APPLICATION OF THE NSCV

The NSCV applies to commercial vessels engaged in domestic operations.

In particular, the NSCV shall apply to—

- a) The design and construction of—
  - i) new vessels;
  - ii) existing vessels subject to initial survey; and
  - iii) existing vessels subject to upgrade in survey.
- b) the competencies of certain persons on board vessels ; and
- c) operational practices on board vessels.

The NSCV may also apply to existing vessels that have been altered and existing vessels without change in survey status to the extent required by applicable legislation.

#### NOTES:

1. Commercial vessel, domestic operation, new vessel, existing vessel, initial survey, upgrade in service and alter are defined in Clause 1.8 below.
2. Design and construction includes arrangement, accommodation, personal safety, watertight integrity, construction, fire safety, engineering, stability and equipment.
3. Part B and the other Parts of the NSCV may also be applicable to non-SOLAS vessels engaged in international operations where a relevant National Authority has adopted them for such purposes. In Australia, the relevant Authority is the Australian Maritime Safety Authority (AMSA).

### 1.3 OVERALL OBJECTIVES OF PARTS B TO F

The objective of Parts B, C, D, E and F of the National Standard for Commercial Vessels is to specify agreed standards for safety certification by government, of vessels and persons engaged in commercial domestic operations in Australia.

Parts B to F of the NSCV do not specify requirements for every aspect of commercial vessel safety, nor do they provide for adequate safety in every instance. For guidance on the duties of persons to provide safety

additional to compliance with Parts B to F, refer to Part A of this National Standard.

NOTE: Vessels are normally also subject to other legislation that is additional to that pertaining to marine safety certification and survey. This standard is not intended to specifically address requirements beyond those of the latter legislation. Other legislation which may impact on the design, construction and operation of a vessel includes that pertaining to:

- a) Health and safety (occupational and public).
- b) Pollution (oil, sewage, garbage, air, noise).
- c) Control of marine traffic and marine activity.
- d) Environmental impacts (visual, wave wake, marine ecology).
- e) Liquor licensing.
- f) Other matters that may not be listed above.

Further information can be obtained from the relevant State, Territory and Local government departments that administer these laws.

#### **1.4 OBJECTIVE OF PART B**

The objective of Part B of the National Standard for Commercial Vessels (NSCV) is to specify the overall framework for a safety system of agreed standards applicable to commercial vessels.

#### **1.5 TRANSITIONAL ARRANGEMENTS**

Where, at a given time, a clause in this National Standard refers to a Part, Section, Subsection, Chapter, Clause or Annex of this standard that has not been published at that time, the clause shall be taken to refer to the relevant provisions within the current version of the USL Code. Where, in the absence of published provisions in the NSCV, the USL Code contains no specific provisions relevant to the clause, then the clause shall not apply to the extent consistent with the context of the reference.

#### **1.6 REFERENCED DOCUMENTS**

Any document referenced in this National Standard should be considered as the latest revision of the document, including amendments.

The following documents are referred to in this Part of the NSCV:

AUSTRALIAN TRANSPORT COUNCIL

*National Standard for Commercial Vessels (all Parts)*

*National Marine Guidance Manual*

COMMONWEALTH OF AUSTRALIA

*Navigation Act 1912*

*Marine Orders 19—Tonnage Measurement*

INTERNATIONAL MARITIME ORGANIZATION

*International Code of Safety for High-Speed Craft 2000 (HSC Code)*

*SOLAS 1997—International Convention for the Safety of Life at Sea*



## STANDARDS AUSTRALIA

AS/NZS 4360—*Risk management***1.7 TERMINOLOGY**

For the purposes of this standard, the terms “must”, “shall”, “should” and “may” shall have the meanings set out in Table 1.

**Table 1 — Context for terminology used in the National Standard for Commercial Vessels**

Term	Where used	Context of usage
must	Required outcomes	Indicates that the safety outcome expressed in the required outcomes is normative <sup>1</sup> for the purposes of compliance with this standard (i.e., mandatory if the standard is adopted by legislation). To be achieved by whatever means.
shall	Prescriptive Clauses	Indicates that a requirement expressed in a prescriptive Clause is normative <sup>1</sup> , <u>but only</u> where the path of compliance with such prescriptive Clauses is chosen in order to be deemed-to-satisfy <sup>2</sup> the required outcomes.
should	Prescriptive solutions, NOTES	Advisory only—informative <sup>1</sup> . Not mandatory for the purpose of compliance with this standard. However, the term is used to highlight safety issues that should be considered and addressed if necessary in order to fulfil safety obligations. See Part A of this National Standard
may	Prescriptive solutions, NOTES	Indicates an option, with or without conditions.

1. The terms normative and informative are defined in Clause 1.8.

2. See Chapter 2 for further information on deemed-to-satisfy solutions.

**1.8 DEFINITIONS**

For the purposes of this National Standard, the following definitions apply, unless expressly stated to the contrary.

**abnormal conditions—**

conditions that fall outside those of normal operation including emergency conditions, having risks that would be unacceptable without specific measures being put in place to eliminate or control those risks.

When determining risk levels, account must be taken of the state of knowledge at the time the risk is assessed, as well as the likelihood of hazards (as an abnormal event) and the magnitude of consequences that might arise from such an event.

## NOTES:

1. The state of knowledge at a given time may be limited by a lack of experience as to the nature of the hazards that may arise, the likelihood of those hazards and the likely consequences that might flow. A lack of knowledge may necessitate the adoption of a more conservative solution, at least until sufficient experience is gained.

A1

2. Collision, grounding, fire, mechanical or structural failure, extreme wind or sea conditions and evacuation are examples of abnormal conditions applicable to many vessels.
3. For guidance on acceptable and unacceptable risk, refer to Annex C.

**accommodation space—**

public spaces, corridors, lavatories, cabins, offices, hospitals, cinemas, games & hobbies rooms, barber shops, pantries containing no cooking appliances, and similar spaces.

**alter—**

to change the vessel such that new measures are required to eliminate or control the risk to health and safety, but does not include routine maintenance, repairs or replacements.

The following examples illustrate potential alterations on a vessel. However, for the purposes of this National Standard, the examples are only deemed to alter the vessel when the change in overall risk would be detrimental to the vessel's safety.

**EXAMPLE 1**

Electrical systems—

an addition or alteration of components or wiring in systems.

**EXAMPLE 2**

Machinery and associated systems—

the addition or alteration of engines, winches, pumping systems, stern gear or the replacement of such items with items that are not identical.

**EXAMPLE 3**

Stability—

alteration in position or amount of permanent ballast.

Alterations to scuppers and freeing ports impairing drainage.

Alteration or replacement of any part of a vessel (including machinery) that, because of its weight or location, alters the stability of the vessel.

**EXAMPLE 4**

Structural sufficiency—

alterations or non-identical replacements to the hull, bulkheads, deck and superstructure.

**EXAMPLE 5**

watertight integrity and subdivision—

alterations or non-identical replacements to the hull, watertight bulkheads, decks, enclosed superstructures and weathertight watertight closing devices.

NOTE: Enabling legislation contains provisions requiring the Authority to be advised of

alterations including replacements. Note that the definition of alter in the applicable legislation may differ from that given above.

**Australian coastal and middle-water operations—**

operations within a range laterally along the coast within a limit of 600 nautical miles to seaward; or within such lesser limits as may be specified.

**Authority—**

the statutory marine authority of the Commonwealth of Australia or of a State or Territory within the Commonwealth.

**breadth—**

in relation to the breadth of a vessel, the maximum breadth measured amidships as follows:

- a) In the case of a metal hull—to the moulded line of the frame.
- b) In the case of any other hull—to the outer surface of the hull.

**cargo space—**

any spaces used for cargo including cargo oil tanks and trunks leading to such spaces.

**classed vessel—**

a vessel in respect of which there is in force a Classification Certificate.

**Classification Certificate—**

a certificate issued by a Classification Society which records the classification accorded to a vessel by that society.

**Classification Society—**

an association for the survey of vessels that has been approved as a survey Authority by AMSA under the Commonwealth Navigation Act.

NOTE: At the time of publication AMSA has approved the following classification societies to act as survey authorities under the Commonwealth Navigation Act:

American Bureau of Shipping  
Bureau Veritas  
Det Norske Veritas  
Germanischer Lloyd  
Lloyds Register of Shipping  
Nippon Kaiji Kyokai

**commercial purpose—**

for the purposes of this National Standard, use in connection with a commercial transaction of any kind including operations—

- a) as a business;
- b) as a service (including a service provided by the Crown);
- c) for profit; or
- d) for research.

**commercial vessel—**

for the purposes of this National Standard means—

- a) any ship, boat or any other type of craft capable of navigation that is used for a commercial purpose including a dinghy; lighter; barge; punt; raft; houseboat; air cushion vehicle or other ground effect craft; but does not include seaplanes or other aircraft; or
- b) a structure designed to float in water that is used for a commercial purpose, other than—
  - i) pontoons or floating jetties that are used only for the purposes of walkways or storage; or
  - ii) similar platforms situated adjacent to river banks or any other shore in circumstances in which they are not being towed or moored away from the shore.

NOTE: The above definition of a commercial vessel is intended solely for determining the application of this technical standard. It may differ from the definition of a commercial vessel specified in legislation for the purposes of determining the application of the legislation, including legislative provisions for certification, exemptions and penalties.

**competent person—**

a person who has acquired through training, qualification, experience, or a combination of these, the knowledge and skills enabling that person to perform the tasks required by this National Standard.

**control station—**

spaces in which the—

- a) vessel's radio or main navigating equipment are located;
- b) emergency source of power and emergency switchboard are located;
- c) fire recording or fire control equipment is centralised; or
- d) other functions essential to the safe operation of the vessel in normal and emergency conditions (such as a public address system) are located.

**crew—**

all persons carried on board the vessel to provide navigation and maintenance of the vessel, its machinery, systems, and arrangements essential for propulsion and safe navigation; or to provide services for other persons on board.

**crew accommodation—**

accommodation provided for the crew of a vessel not being accommodation which is also used by, or provided for the use of, passengers.

**depth—**

in relation to the depth of a vessel, the moulded depth measured at the middle of the measured length from the moulded line of the keel to the top of the freeboard deck beams at the side of the vessel, see Figure 1(a).

For the purposes of this definition, the moulded line of the keel is the top of the keel where a plate keel is fitted, see Figure 1(c).

In the case of a timber or composite vessel, the moulded line of the keel shall be read as a reference to the lower edge of the keel rabbet, see Figure 1(b).

In the case of a vessel which has a bar keel, as shown in Figure 1(e) or in which the form at the lower part of the midship section is of a hollow

character, or thick garboards are fitted, the moulded line of the keel shall be read as a reference to the point where the flat of bottom continued inwards cuts the side of the keel of the vessel, see Figure 1(d).

In every case the moulded line of the keel shall be horizontal when extended transversely.

NOTE: The middle of the measured length  $L_M$  is located—

- a)  $0.5 L_M$  from the fore part of the hull when the measured length is based on the length on deck  $L_D$ ; or
- b)  $0.5 L_M$  from the foremost part of the hull when the measured length is based on 96 per cent of the length overall  $L_{OA}$

Refer to definition of measured length and Annex A.

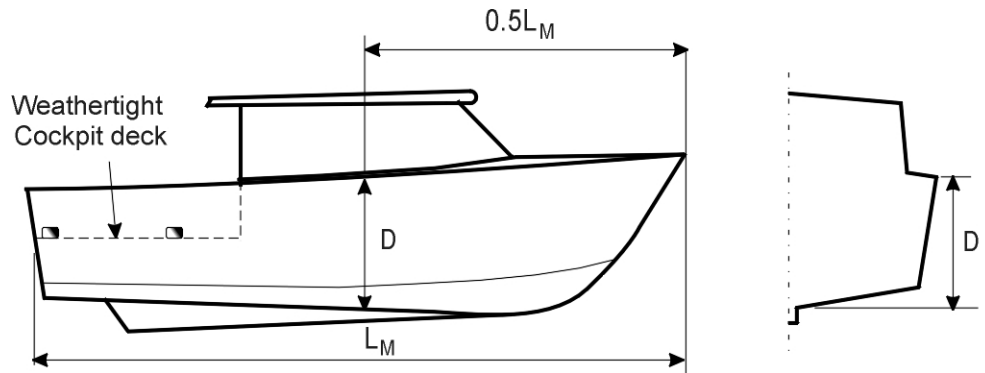

a) Vessel having discontinuous sheer

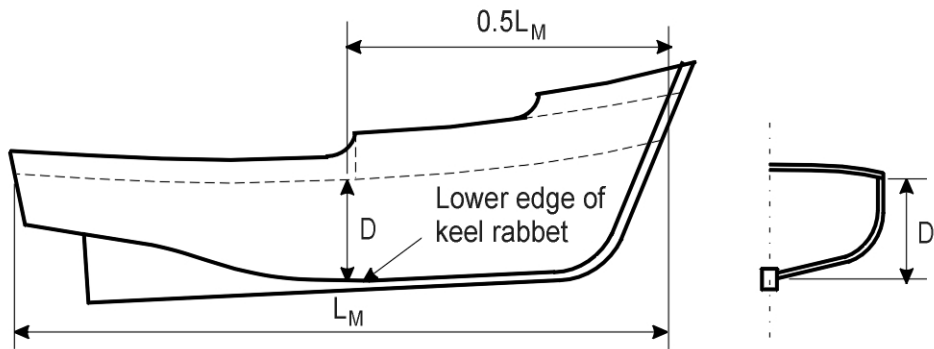

b) Timber vessel with rise of keel and deck camber

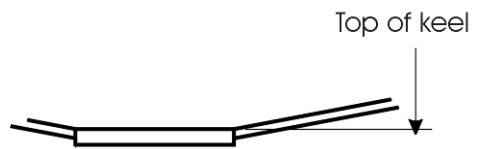

c) Flat plate keel

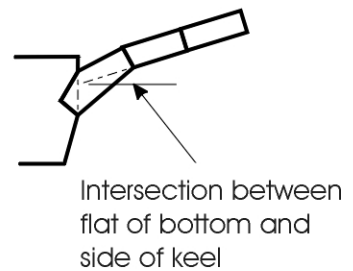

d) Vessel with hollow garboards

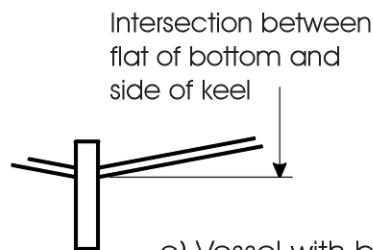

e) Vessel with bar keel

**Figure 1 — Measurement of the depth of a vessel**

**domestic operations—**

operations which do not include international voyages. A vessel is engaged in domestic operations if the place of departure and the first place of arrival are within Australia, notwithstanding that the vessel may travel through waters which are outside Australian territorial limits.

**existing vessel—**

a vessel which is not a new vessel.

**fast craft—**

a vessel capable of maximum speed equal to or exceeding 25 knots.

NOTE: Requirements for fast craft are contained in Part F Section (Fast Craft) of the NSCV.

**fish—**

a living resource of the sea or seabed.

**fishing operations—**

means—

- a) the farming, taking, catching or capturing of fish for trading or manufacturing purposes;
- b) the processing or carrying of the fish that are farmed, taken, caught or captured; or
- c) activities in support of fishing operations, including—
  - i) the feeding, storage or transport of fish farmed, taken, caught or captured by the fishing vessel;
  - ii) the provision of food, fuel and other supplies to the fishing vessel while it is engaged in fishing operations;
  - iii) the transport of crew members or special personnel to and from the fishing vessel while it is engaged in fishing operations; and
  - iv) the maintenance of fish farms.

**fishing vessel—**

means—

- a) a vessel that is used for fishing operations; or
- b) a vessel that—
  - i) is in the course of construction; and
  - ii) is intended to be used for fishing operations.

**gross tonnage (GT)—**

a measurement of the volume enclosed by a vessel, measured in accordance with Marine Orders 19.

**hazard—**

a thing, or a state of a thing, that has potential to cause death, injury, illness or environmental damage.

NOTE: A hazard may also have the potential to cause other forms of loss; i.e. economic, social and political. See Annex B of this Part.

**hire and drive vessel—**

any vessel that is let for hire or reward, or for any other consideration whatsoever, and that the hirer uses solely for pleasure.

**EXAMPLE**

A vessel provided in conjunction with holiday establishments or hotels for the use of guests or tenants.

NOTE: Requirements for hire and drive vessels are contained in Part F Section 2: Hire and Drive of the NSCV.

**informative—**

not mandatory for the purposes of compliance with this standard.

NOTE: Although not mandatory for the purposes of compliance with this Standard, an informative provision may provide guidance that assists users to meet mandatory safety obligations under OH&S law and the general law, see Part A.

**initial survey—**

the process by which a commercial vessel is investigated and verified that it meets prescribed standards for the first time.

**inshore operations—**

operations laterally along the coast from the base or regular port of departure, and within a limit of 15 nautical miles to seaward of the coast or of designated sheltered water limits; or within such lesser limits as may be specified.

**length—**

in relation to a vessel, a longitudinal measure of the vessel used for the purposes of estimating risk, complexity, mass, volume or other characteristics. A number of different defined types of length are used within this National Standard to accommodate the specific needs of particular sections.

NOTE: The definition of measured length is contained within this Part of the NSCV. Definitions for load line length and waterline length are specified within the relevant Parts and Sections of this National Standard.

**marine orders—**

orders made under the Navigation Act (1912) (Commonwealth)

**master—**

in relation to the function performed on the vessel, the person having command or charge of the vessel.

NOTE: The title given to the person in command, or the name of the qualification held by that person, does not change the function of the master. A person having command of a vessel may be referred to on board that vessel by titles such as Captain, Skipper, Coxswain or Master, but is deemed to function as master for the purposes of this Standard.

**maximum speed—**

the speed achieved at the maximum continuous propulsion power for which the machinery is rated at maximum operational weight and in smooth water.

**may—**

a term having the meaning specified in Clause 1.7.



**measured length ( $L_m$ )—**

means the greater of—

- a)  $L_D$ ; and
- b)  $0.96 L_{OA}$ .

where

$L_D$  = the length on deck, in metres (see definition in Clause A4).

$L_{OA}$  = the length overall, in metres (see definition in Clause A4).

NOTE: Guidance on establishing measured length is contained in Annex A of this Part of the NSCV.

**must—**

a term having the meaning specified in Clause 1.7.

**nautical mile (nm)—**

the International nautical mile of 1852 metres.

**new vessel—**

a vessel the keel of which is laid, or which is at a similar stage of construction on or after the coming into force of the applicable Part, Section or Subsection of this National Standard.

In this definition similar stage of construction means the stage of construction of the vessel at which—

- a) construction identifiable with the particular vessel has begun; and
- b) a portion of the vessel has been fabricated and finally assembled, having a mass of not less than the lesser of—
  - i) 50 tonnes; or
  - ii) one per cent (1 per cent) of the estimated mass of all structural material of the vessel as proposed to be completed.

**non-passenger vessel—**

a vessel that is not—

- a) a passenger vessel;
- b) a fishing vessel; or
- c) a hire and drive vessel.

NOTE: A non-passenger vessel may be certified to carry up to 12 passengers.

**normative—**

mandatory for the purposes of compliance with this standard.

**novel vessel—**

a vessel for which the hazards and risks are not adequately addressed by the requirements for conventional vessels contained in Parts B to E of the NSCV, and that are not, apart from Part F Section 3, otherwise specifically addressed in Part F—Special Vessels of the NSCV.

NOTE: Requirements for novel vessels are contained in Part F Section 3 of the NSCV.

**offshore operations—**

an operational area as defined in Clause 3.4.2.

**open vessel—**

a vessel which has no weathertight deck for the whole or part of the length of the vessel.

**EXAMPLE 1**

A rowing boat with open bottom boards

**EXAMPLE 2**

A half-cabin vessel with a cockpit aft fitted with loose deck panels.

**operational area—**

a geographical limit on a vessel's operation used in determining the nature and magnitude of risk, and the nature of solutions to control that risk. See Clause 3.4.

NOTE: The geographical limits may reflect limitations on the vessel's ability to operate in heavy or extreme weather or wave conditions.

**operational speed—**

90 per cent of the maximum speed.

**owner—**

any person exercising or discharging or claiming the right or accepting the obligation to exercise or discharge any of the powers or duties of an owner of a vessel whether on their own behalf or on behalf of another, and includes a person who is the owner jointly with any other person or persons and the manager or secretary of any body corporate or company.

**partially smooth water operations—**

an operational area as defined in Clause 3.4.2.

**partially smooth waters—**

waters where the significant wave height does not exceed 1.5 m from trough to crest for at least 90 per cent of the time.

**passenger—**

any person other than—

- a) the master and other members of the crew;
- b) a person designated as special personnel; or
- c) a child under one year of age.

**passenger vessel—**

a vessel which carries, or is certified to carry, more than 12 passengers.

**restricted offshore operations—**

an operational area as defined in Clause 3.4.2.

**risk—**

the chance that one or more hazards will cause something to happen that will have a detrimental impact upon safety. It is measured in terms of the likelihood and consequences of injury, illness or environmental damage.

NOTE: A fatality may be a consequence of injury or illness.

**risk assessment—**

the process of evaluating the probability and consequences of injury, illness or environmental damage arising from exposure to identified hazards associated with a vessel.

**safe haven—**

A place that can reduce the risk to a vessel and those persons on board the vessel by providing shelter from the sea and weather. A safe haven includes a port, harbour, designated sheltered water area and an inlet or river mouth that offers a good anchorage.

NOTE: Whether a place is a safe haven is a function of the characteristics of the locality together with the risks encountered in leaving or reaching a safe haven, which include the current weather wave condition and the characteristics of the vessel.

**seagoing—**

any one of the operational areas defined as seagoing in Clause 3.4.1.

**service category—**

the framework used in the NSCV to classify vessels according to the types and levels of risk likely to be encountered. The service category is determined by the nature of the vessel's use and its operational area. See Clause 3.5.

**service space—**

spaces used for galleys, main pantries, sales shops, store rooms (except isolated pantries and lockers of floor area not greater than 2 m<sup>2</sup>), mail rooms and workshops. Workshops that are located in machinery spaces or in trunks to a machinery space, are excluded.

**shall—**

a term having the meaning specified in Clause 1.7.

**sheltered waters—**

waters comprising designated smooth and partially smooth waters.

**should—**

a term having the meaning specified in Clause 1.7.

**significant wave height—**

the mean value of the highest one-third of wave heights measured from trough to crest recorded in a wave time history.

NOTE: It is probable that one in every 1000 waves will have a height at least 1.86 times the significant wave height.

**smooth water operations—**

an operational area as defined in Clause 3.4.2.

**smooth waters—**

waters where the significant wave height does not exceed 0.5 m from trough to crest for at least 90 per cent of the time.

**special personnel—**

all persons who—

- a) have knowledge of safety procedures and handling of safety equipment on board;

- b) are not passengers, or members of the crew, or children under one year of age;
- c) are carried on board in connection with the special purpose of that vessel, or because of special work being carried out aboard that vessel; and
- d) are able bodied.

**special purpose vessel—**

a vessel that is either—

- a) a non-passenger vessel which by reason of its function carries on board a total of more than 12 special personnel and passengers, or
- b) a fishing vessel which by reason of its function carries on board more than 12 special personnel.

**EXAMPLE**

Examples of special purpose vessels may include:

- Ships engaged in research, expeditions and survey
- Ships for training of marine personnel
- Fish factory ships and ships processing other living resources of the sea, or seabed

NOTE: Requirements for special purpose vessels are contained in Part F Section 4 (Special Purpose Vessels) of the NSCV.

**superstructure—**

a decked structure, including a raised quarter deck on the freeboard deck, extending from side to side of the vessel or with the side plating of the structure not being inboard of the shell plating by more than 4 per cent of the breadth of the vessel.

Where, in pursuance of the above, a lower deck is specified as the freeboard deck of a vessel, any part of the hull that extends above the deck so specified shall be deemed to be a superstructure.

**tanker—**

a cargo vessel constructed or adapted for the carriage of bulk fluid cargoes.

**unclassified vessel—**

a vessel that is not a classed vessel.

**unlimited domestic operations—**

an operational area as defined in Clause 3.4.2.

**unmanned machinery space—**

a decked propulsion machinery space that under normal operating conditions is not occupied or is intermittently occupied.

**upgrade in service—**

a change in the service category which will, in any way, subject the vessel or persons on the vessel to an increase in risk.

**vessel—**

a commercial vessel as defined above.

**1.9 ABBREVIATIONS****AMSA—**

Australian Maritime Safety Authority

**GT—**

gross tonnage

**IMO—**

International Maritime Organization

**NSCV—**

National Standard for Commercial Vessels

**NMSC—**

National Marine Safety Committee

**RIB—**

rigid inflatable boat

**SOLAS—**

Safety of Life at Sea – refers to the IMO International Convention for the Safety of Life at Sea

**USL Code—**

Uniform Shipping Laws Code

**WIG—**

wing-in-ground effect craft

**1.10 NATIONAL MARINE GUIDANCE MANUAL**

The National Marine Guidance Manual contains material for the guidance of users of the NSCV, including interpretations and details of corrections. Persons using this National Standard should also refer to the National Marine Guidance Manual to ascertain whether it contains documentation relevant to a particular Part or Section of this National Standard.

## CHAPTER 2 USE OF PARTS B TO F OF THE NATIONAL STANDARD

### 2.1 SCOPE

This Chapter describes the structure of the National Standard for Commercial Vessels and how the standard is to be used and applied to commercial vessels.

### 2.2 OBJECTIVE

The objective of Chapter 2 is to provide—

- a) structured methods for the uniform application of this standard; and
- b) flexibility in the solutions adopted for the control of risk.

#### NOTES

1. Hazards associated with failing to achieve uniform application of this standard include: reduction in safety standards below acceptable levels, and barriers against the free movement of vessels between jurisdictions.
2. Hazards associated with failing to provide for flexibility in solutions include: the stifling of innovation in the design, construction and operation of vessels.
3. Consequences of such risks if left uncontrolled include: increased potential for death or injury to persons, degradation of safety standards within a jurisdiction, an additional economic burden placed on all parties concerned with vessel safety, uncertainty and conflict within the industry and loss of competitive advantage.

### 2.3 STRUCTURE OF THE NSCV

#### 2.3.1 General

Parts B, C, D, E and F of the NSCV contain:

- a) Scope
- b) Application
- c) Objectives
- d) Required outcomes
- e) Solutions
- f) Notes

#### 2.3.2 Scope

The scope defines the general subject of a particular Part, Section, Subsection, Chapter or Annex in the NSCV and appears as the first clause.

#### 2.3.3 Application

The application clause specifies those persons or vessels subject to the content of a particular Part, Section, Subsection, Chapter or Annex in the NSCV, as well as those persons or vessels specifically excluded. In some instances the application may be covered in the scope clause.

### 2.3.4 Objectives

Objectives are a statement of what is intended by a particular Part, Section, Subsection or Chapter in the NSCV. Objectives are framed to reflect community expectations. They are to be used as an aid to the interpretation of the NSCV and not to be used as the criteria for determining compliance with the NSCV. Notes attached to some objective statements contain guidance as to hazards and consequences associated with particular risks.

### 2.3.5 Required outcomes

Required outcomes state the essential outcomes that must be met for compliance with the National Standard. Required outcomes are specified in the National Standard by the terminology “must”. The required outcomes may state the level of compliance required, but more frequently will not be quantified.

NOTE: For information on how to determine whether a solution satisfies a required outcome that is not quantified, refer to Clause 2.7.

### 2.3.6 Solutions

Solutions are the means adopted for eliminating or controlling risk. They frequently comprise a combination of technical and operational measures for controlling risk that together form an element of the safety system of the vessel. A solution must comply with the relevant required outcomes specified in the National Standard. The safety system may comprise—

- a) deemed-to-satisfy solutions;
- b) equivalent solutions; or
- c) a combination of a) and b).

#### 2.3.6.1 *Deemed-to-satisfy solutions*

Deemed-to-satisfy solutions are solutions that are deemed-to-satisfy the required outcomes. Deemed-to-satisfy solutions are specified within the NSCV using the terminology “shall”. They are normally prescriptive in form and represent one common means of meeting the required outcomes. Proof of compliance with the prescription is deemed-to-satisfy the standard specified in the required outcomes, see Clause 2.7.3 a).

#### 2.3.6.2 *Equivalent solutions*

Equivalent solutions are solutions that satisfy the required outcomes by a means that differs from that prescribed for deemed-to-satisfy solutions in this National Standard. They are performance-based solutions that must be proven to satisfy the required outcomes to the extent specified within the standard.

An equivalent solution must be assessed according to one or more of the assessment methods specified in Clause 2.7.3. An equivalent solution will only comply with the NSCV if the assessment methods used to determine compliance with the required outcomes have been satisfied.

**2.3.7 Notes**

Notes are informative and contain information provided for advice only. Notes often take the form of a suggestion or recommendation. Compliance with the objectives, required outcomes and deemed-to-satisfy solutions can still be achieved without necessarily meeting recommendations contained in notes. However, such recommendations may highlight safety issues that should be considered and addressed as necessary in order to fulfil a person's wider safety obligations.

**REQUIRED OUTCOMES****2.4 LEVEL OF SAFETY**

Solutions for the control of risk must satisfy the required outcomes to a level of safety at least equivalent to that of the deemed-to-satisfy solutions specified within this National Standard.

**2.5 BASIS OF SOLUTIONS**

Solutions for the control of risk must be based on sound quantitative or qualitative data.

**2.6 DOCUMENTATION**

Solutions for the control of risk must be documented to permit third party audit or review.

**DEEMED-TO-SATISFY SOLUTIONS****2.7 COMPLIANCE****2.7.1 General**

A solution shall comply with the NSCV if it satisfies the required outcomes and that compliance is documented (see Clause 2.7.4). Compliance with required outcomes can only be achieved by—

- a) complying with a deemed-to-satisfy solution; or
- b) formulating an equivalent solution which—
  - i) complies with the required outcomes; or
  - ii) is shown to be at least equivalent to the deemed-to-satisfy solution.

**2.7.2 Equivalent solutions**

Equivalent solutions are alternative solutions that give levels of safety no less than that provided by the deemed-to-satisfy solution. Equivalent solutions may be one of two types—

- a) generic equivalent solutions; or
- b) local equivalent solutions.



### **2.7.2.1 Generic equivalent solutions**

Generic equivalent solutions are solutions that are independent of the circumstances of a particular locality or operation within a locality. Generic equivalent solutions shall continue to fulfil the applicable required outcomes, notwithstanding that a vessel may transfer to a different locality or jurisdiction or may engage in a different operation within the limits of its service category.

### **2.7.2.2 Local equivalent solutions**

Local equivalent solutions are solutions that are specifically customised for the circumstances of a particular locality or operation within a locality. Local equivalent solutions shall fulfil the applicable required outcomes while the vessel is operating within the particular locality or operation. Information and controls shall be provided to ensure that the effectiveness of the safety system is reassessed prior to the vessel being used in another locality or for an operation where the same special circumstances no longer apply. Additional measures to control risk shall be provided if, upon reassessment, the standard of safety falls below that specified in this National Standard.

NOTE: The choice of whether to adopt a generic or local equivalent solution is an economic matter to be determined by the applicant. A generic equivalent solution is more suited to vessels that travel between jurisdictions or localities on a regular basis, or that are built to a standard design for use anywhere within Australia. A local equivalent solution is more suited to a vessel dedicated to a particular operation within a particular locality.

### **2.7.3 Assessment methods**

The following assessment methods, or any combination of them, may be used to determine whether a solution complies with the required outcomes:

- a) Evidence to support that the use of a material, form of construction, design or system of work meets a deemed-to-satisfy solution.
- b) Evidence to support that the use of a material, form of construction, design, or system of work meets the applicable required outcomes.
- c) Quantitative comparison with the deemed-to-satisfy solution.
- d) Quantitative risk analysis.
- e) Expert judgement with or without qualitative risk analysis.

NOTES:

1. Proving that an equivalent solution provides equivalent safety can be time consuming and expensive. Specialised professionals and test facilities may be required. The onus to show equivalence normally lies with the applicant.
2. Guidelines for hazard identification, risk assessment and control of risk are provided in Annex B of this Part. Guidance on acceptable risk is given in Annex C of this Part.
3. AS/NZS 4360 provides further information on the risk management process.

#### 2.7.4 Documentation of decisions

Decisions made under the NSCV shall be fully documented and copies of all relevant documentation shall be retained for future reference, which may include third party audit.

Examples of the kind of documentation that should be prepared and retained include:

- a) Details of the solution including all relevant plans and other supporting documentation (refer to Annex D of this Part).
- b) In cases where an equivalent solution has been proposed—
  - i) details of the relevant required outcomes;
  - ii) the assessment method or methods used to establish compliance with the relevant required outcomes;
  - iii) details of any expert judgement relied upon including the extent to which the judgement was relied upon and the qualifications and experience of the expert;
  - iv) details of any tests or calculations used to determine compliance with the relevant required outcomes;
  - v) test certificates, classification certificates or other documentation from an appropriate body which verify that a solution meets an applicable standard; and
  - vi) details of any standards or other information which were relied upon.

#### 2.7.5 Provision of information

Information relevant to achieving and maintaining the safety effectiveness of the solution shall be provided to those parties responsible for the safety of the vessel.

##### EXAMPLE 1

Manuals for stability, operation, maintenance and training

##### EXAMPLE 2

Fire control, emergency and damage control plans

NOTE: Refer to Annex D for further information.

#### 2.7.6 Classed vessels deemed-to-satisfy

A vessel designed, constructed and maintained in accordance with the rules of a classification society (i.e. a classed vessel) shall be deemed-to-satisfy the relevant required outcomes of this National Standard to the extent provided for by those rules and subject to any conditions or limits specified on the classification certificate.

NOTE: Classification Society rules frequently omit specific requirements for those aspects of vessel safety that are normally the responsibility of the Authority, especially those items expressly specified by legislation; e.g. safety equipment, stability, subdivision, etc. Care should be taken to ensure that all essential outcomes as

expressed by required outcomes are adequately addressed, notwithstanding that a vessel is in class.

### **2.7.7 Classification Society rules, design approval and/or initial survey without maintaining class**

The use of classification society rules, design approval or initial survey without maintaining class shall be considered on a case-by-case basis as a proposal for an equivalent solution under Clause 2.7.2 above. The onus of proving compliance with the required outcomes lies with the applicant (see Clause 2.7.3).

High performance, novel or complex vessels such as fast craft or submersibles should be constructed and maintained in class to ensure that the safety outcomes provided for in the classification society rules are properly achieved and maintained.

NOTE: Some Classification Societies do not support the use of their rules or services on unclassified vessels on the basis that doing so would not be in accordance with quality management principles. Their concern is that in-house training, procedures, and guidance material necessary for the proper use of the rules and the initial and on-going inspection of the vessel would be unavailable to persons outside the classification society.

### **2.7.8 Special vessels—fast craft, hire and drive vessels, novel vessels, special purpose vessels, etc.**

Vessels that have hazards and risks that cannot be adequately or appropriately addressed by the requirements for conventional vessels contained in Parts B to E of the NSCV, shall comply with the requirements contained in Part F—Special Vessels.

## **2.8 MATERIALS, FITTINGS, EQUIPMENT AND WORKMANSHIP**

### **2.8.1 General**

All materials, fittings, equipment and workmanship essential to the safety of the vessel or persons that is used in the construction and fitout of the vessel shall have characteristics of quality and reliability no less than that needed to achieve the required outcomes listed within this National Standard.

### **2.8.2 Location of equipment and fittings**

Equipment and fittings required by this National Standard shall be positioned so as not to impede the free movement of persons while at the same time being readily available for their intended use.

### **2.8.3 Verification**

Unless otherwise specified, the characteristics of quality and reliability of materials, fittings, equipment and workmanship essential to the safety of the vessel or persons shall comply with a relevant national or international standard or shall be verified by other means such as inspection and/or testing.

#### **2.8.4 Documentation**

The verification of quality and reliability of materials, fittings, equipment and workmanship essential to the safety of the vessel or persons shall be documented.

##### NOTES

1. The quality of materials, fittings and equipment can be better assured by sourcing these items from reputable manufacturers, especially those having an accredited quality management system in place.
2. Standards of workmanship can be controlled by ensuring that only competent persons are engaged in activities that may impact on the safety of the vessel or persons.

## CHAPTER 3 CATEGORIES OF VESSELS

### 3.1 SCOPE

This Chapter provides details of the system used for the categorisation of vessels under this National Standard.

### 3.2 OBJECTIVE

The objective of Chapter 3 is to provide a broad framework that models the types of hazards and levels of risk associated with a particular vessel and its intended operation so that the vessel is designed, constructed and operated with measures for controlling or eliminating risk that are appropriate for the nature of the vessel's use, the characteristics of persons on board and the area of operation.

NOTE: The categorising of vessels by type of use and area of operation enables the major hazards and their associated risks to be readily ascertained. This information then forms the basis for determining the nature of solutions needed to achieve the required outcomes.

### 3.3 VESSEL USE CATEGORIES

For the purposes of the NSCV, a vessel shall be categorised according to its use as shown in Table 2.

**Table 2 — Vessel use categories**

Vessel use	Denoted by
Passenger vessel	1
Non-passenger vessel	2
Fishing vessel	3
Hire and drive vessel	4

NOTE: Each use is defined in Clause 1.8

### 3.4 OPERATIONAL AREA CATEGORIES

#### 3.4.1 Designation

For the purposes of the NSCV, a vessel shall be categorised according to its area of operation as shown in Table 3.

**Table 3 — Operational area categories**

Operational area	Denoted by
<b><i>Seagoing</i></b>	
—Unlimited domestic operations	A
—Offshore operations	B
—Restricted offshore operations	C
<b><i>Sheltered waters</i></b>	
—Partially smooth water operations	D
—Smooth water operations	E

### 3.4.2 Definitions of operational area categories

In relation to the limits of a vessel's area of operations, each of the operational areas listed under Clause 3.4.1 is defined as follows:

**unlimited domestic operations—**

all domestic operations greater than 200 nautical miles to seaward of the coast.

**offshore operations—**

operations within a limit of 200 nautical miles to seaward of the coast; or within such lesser limits as may be specified.

**restricted offshore operations—**

operations within—

- a) 30 nautical miles from the seaward limit of a safe haven<sup>1</sup>, including designated smooth or partially smooth waters (i.e. sheltered waters), or within such lesser limits as may be specified; or
- b) specified waters designated by the Authority as “restricted offshore”<sup>2</sup>

**partially smooth water operations—**

operations within specified geographical limits in waters designated by the Authority as partially smooth waters (see also Clause 1.8—definition of partially smooth waters).

<sup>1</sup> Restricted offshore operations are based upon the assumption that the vessel will not be required to bear the full force of the weather at sea; i.e. prior to encountering bad weather the vessel can cease operation and seek shelter. For restricted offshore operations, it is assumed that the vessel has access to timely and accurate weather forecast information.

<sup>2</sup> Contact the relevant State or Territory Authority for details of any areas nominated as designated restricted offshore waters within their jurisdictions.

**smooth water operations—**

operations within specified geographical limits in waters designated by the Authority as smooth waters (see also Clause 1.8—definition of smooth waters).

NOTE: State or Territory Authorities can be contacted regarding areas nominated as Smooth and Partially Smooth Waters within their respective jurisdictions.

**3.5 SERVICE CATEGORIES****3.5.1 General**

Vessels shall be assigned a service category, according to the nature of vessel use (see Clause 3.3) and the intended operational area (see Clause 3.4.1). Table 4 lists and describes the various combinations that form the service categories.

**Table 4 — Service categories**

<b>Service Category</b>	<b>Description</b>
Class 1A	Seagoing passenger vessel for use in all operational areas up to and including unlimited domestic operations.
Class 1B	Seagoing passenger vessel for use in all operational areas up to and including offshore operations.
Class 1C	Seagoing passenger vessel for use in all operational areas up to and including restricted offshore operations.
Class 1D	Sheltered waters passenger vessel for operations in partially smooth and smooth waters only.
Class 1E	Sheltered waters passenger vessel for use in smooth waters only.
Class 2A	Seagoing non-passenger vessel for use in all operational areas up to and including unlimited domestic operations.
Class 2B	Seagoing non-passenger vessel for use in all operational areas up to and including offshore operations.
Class 2C	Seagoing non-passenger vessel for use in all operational areas up to and including restricted offshore operations.
Class 2D	Sheltered waters non-passenger vessel for operations in partially smooth and smooth waters only.
Class 2E	Sheltered waters non-passenger vessel for use in smooth waters only.
Class 3A	Seagoing fishing vessel for use in all operational areas up to and including unlimited domestic operations.
Class 3B	Seagoing fishing vessel for use in all operational areas up to and including offshore operations.
Class 3C	Seagoing fishing vessel for use in all operational areas up to and including restricted offshore operations.
Class 3D	Sheltered waters fishing vessel for operations in partially smooth and smooth waters only.
Class 3E	Sheltered waters fishing vessel for use in smooth waters only.
Class 4C	Seagoing hire and drive vessel for use in all operational areas up to and including restricted offshore operations.
Class 4D	Sheltered waters hire and drive vessel for operations in partially smooth and smooth waters only.

Class 4E	Sheltered waters hire and drive vessel for use in smooth waters only.
----------	---

### 3.6 SPECIAL SERVICE NOTATION

#### 3.6.1 General

A special service notation shall be added to the service category specified in Table 4 where the vessel is of a specialised type that requires special measures for the control of risk.

#### 3.6.2 Notation

A special service notation denotes a vessel engaged in operations where there are specific risks to be controlled or other factors beyond those contemplated in the service categories listed under Clause 3.5.1 above. A special service notation shall be assigned to the following types of operation in accordance with Table 5.

**Table 5 — Special Service Notations**

Operations	Notation
Fast craft	(FAST)
Novel or unusual vessels	(NOV)
Special purpose vessels	(SP)
Other craft	Notation to be determined as the need arises

#### EXAMPLE

Class 1C (FAST) means a seagoing passenger fast craft for operations in restricted offshore areas.

Class 1D (NOV) means a sheltered waters passenger novel craft for operations in partially smooth waters.

Class 3C (SP) means a seagoing fishing special purpose vessel for operations in restricted offshore areas.

#### 3.6.3 Standards

Vessels having a special service notation are subject to standards that add to, modify, or replace the requirements for conventional vessels contained in Parts C to E of this National Standard. These standards may be provided in Part F of the NSCV, or in their absence, a relevant national or international standard for the specific type of vessel, its hazards and risks, shall be applied.

NOTE: Classification societies can offer class for a diverse range of vessels including submersibles, WIGs, offshore platforms, etc.



### **3.7 MULTIPLE SERVICE CATEGORIES**

#### **3.7.1 General**

A vessel shall be assigned more than one service category where the vessel or its operation is not adequately defined by a single service category.

#### **3.7.2 Non-concurrent operations**

A vessel with multiple service categories, which are not concurrent, shall comply with the standard for the control of risk corresponding to the type of operation in which the vessel is engaged at that particular time.

NOTE: Legislation or other factors may necessitate certain standards for the control of risk on a vessel be maintained for all categories of service for which the vessel is certified, notwithstanding that the vessel may not be operating within a given service category at a particular time.

#### **3.7.3 Concurrent operations**

Where a vessel has multiple service categories and such operations are concurrent, the vessel shall be capable of complying with the standards for the control of risk applicable to each of the concurrent service categories.

NOTE: Not all operations corresponding to service categories are compatible for concurrent application; e.g. the carriage and transfer of cargo oil with passengers on board. Where special hazards and increased risks arise through concurrent operations, these should be identified and controlled.

### **3.8 MINIMUM LENGTH OF SEAGOING PASSENGER VESSELS**

Seagoing passenger vessels of class 1A, 1B and 1C shall be a minimum of 10 m in measured length.

### **3.9 LIMITATIONS ON THE USE OF OPEN VESSELS AT SEA**

Open vessels shall not carry passengers to sea, nor be used for hire and drive service at sea, except where the vessel is limited to class 2C or 4C service, and it is an inflatable, Rigid Inflatable Boat (RIB), or similar vessel that is fitted with buoyancy chambers or buoyancy foam such that its swamped buoyancy and damaged stability characteristics are equivalent to those for a decked vessel.

### **3.10 DESIGN ENVIRONMENTAL PARAMETERS FOR EQUIVALENT SOLUTIONS**

#### **3.10.1 Operational areas**

Subject to Clauses 3.10.2 and 3.10.3, the design environmental parameters corresponding to each operational area given in Clause 3.4 shall be, for the purposes of proving equivalent solutions, in accordance with Table 6.

#### **3.10.2 Conditions more severe than the design parameters**

Where a vessel's operation will be such that conditions more severe than those specified in Clause 3.10.1 are likely to be encountered, e.g. patrol or rescue craft, the solution should be capable of providing equivalent safety in those conditions.

### 3.10.3 Conditions less severe than the design parameters

Where a vessel's operation will be such that conditions less severe than those specified in Clause 3.10.1 will be encountered, then the design parameters may be reduced accordingly, provided they can be proven to be an equivalent solution. Information shall be provided and a system of work adopted to ensure that the vessel does not operate in conditions that exceed the design environmental parameters. Reductions in design conditions for a particular service shall be considered as a local equivalent solution, refer to Clause 2.7.2.2.

**Table 6 — Design environmental parameters**

	<b>Class A</b>	<b>Class B</b>	<b>Class C</b>	<b>Class D</b>	<b>Class E</b>
Operational Characteristics	Independent operation at sea	Independent operation at sea	Restricted operation within a few hours travel of the coast	Operation within Sheltered Waters	Operation within Smooth Waters
Weather and sea characteristics	Survives all but the most extreme weather or sea conditions	Survives all but the most extreme weather or sea conditions	Avoids gale-force weather and very rough seas <sup>3</sup>	Avoids gale-force weather and rough seas <sup>3</sup>	Avoids gale-force weather and operates only in small waves <sup>3</sup>
Survival and rescue infrastructure	Early rescues not likely. Possible lengthy period in survival mode	Planes for early location and helicopters for rescue out to about 100nm	Survival in benign conditions or rescue within a relatively short time	Rescue facilities and/or shoreline nearby	Rescue facilities and/or shoreline readily available
Assumed gusting wind Pressure (Pa)	600	600	450	360	300
Beaufort Scale	9 (strong gale)	9 (strong gale)	7 (near gale)	6 (strong breeze)	6 (strong breeze)
Design significant wave height <sup>1, 2</sup> (m)	>6	>6	4.5	2.5	0.6
Water temperature <sup>4</sup>	7-37°C	7-37°C	7-37°C	7-37°C	7-37°C
Air temperature <sup>4</sup>	1-45°C	1-45°C	1-45°C	1-45°C	1-45°C

LEGEND

1. Conditions where waves are breaking such as over river bars or on shorelines present additional hazards.
2. The maximum probable wave height can be up to twice the significant wave height.
3. The Bureau of Meteorology issues routine coastal waters forecasts several times daily for areas within 60 nautical miles of the Australian coast.
4. No provision has been made for vessels intended for operations in areas prone to freezing or icing.

## ANNEX A METHODS FOR ESTABLISHING MEASURED LENGTH

### A1 SCOPE

This Annex A specifies methods for establishing the measured length of a vessel referred to in Clause 1.8 of this Part. It forms a normative part of this document.

### A2 OBJECTIVE

The objective of the measurement of length is to establish the magnitude of a key parameter used for estimating the nature and magnitude of risks that pertain to a vessel.

NOTE: Length is used in determining the relevant provisions for a number of vessel characteristics including the following:

- a) The seagoing operation of passenger vessels.
- b) The limits of the detailed NSCV construction and machinery provisions.
- c) Crewing and competency requirements.
- d) Load line, weathertight and watertight integrity.
- e) Accommodation and railing requirements.
- f) Fire safety and equipment.
- g) Lifesaving equipment.
- h) Stability standards.

### A3 APPLICATION

This Annex applies to all vessels.

### A4 TERMINOLOGY

The following terms used in the definition of Measured Length shall be interpreted as follows:

**length on deck ( $L_D$ )—**

the distance from the fore part of the hull to the after part of the hull, measured parallel to the design loaded waterline.

**length overall ( $L_{OA}$ )—**

the distance measured parallel to the design loaded waterline from the foremost part of the hull to the aftermost part of the hull, excluding appendages.

**fore part of the hull—**

the point at the intersection of the leading edge of the shell plating, planking or other structural material with the upper side of the uppermost weathertight deck or, in the case of an open vessel, at the height of the gunwale. In the case of bar stems or stem posts, the intersection lies at the point where the outside of the shell plating or planking meets with the stem bar or post. Members added to the exterior of the hull, e.g. fender, sponson, rubbing strip, etc., shall be excluded.

NOTE: Further guidance on the location of the fore part of the hull is given in Figure A.1.

**foremost part of the hull—**

is the most forward point of the vessel. In all cases the following applies:

- a) Members added to the vessel and not forming part of the structure of the vessel shall be excluded, e.g. fenders, pulpit rails, bow door or ramp, sponsons, rubbing strip, bowsprits, bumpkins, etc.
- b) Bulwarks shall be taken as part of the vessel.
- c) Integrally formed, welded or moulded components and other appendages that provide buoyancy shall be included in the measurement of length overall including integral long-line fishing platforms. Integrally formed bowsprits, pulpits and other such structures may be excluded provided the total width of the structure is not greater than 30 per cent of the total breadth of the hull (or hulls if the vessel is of multihull configuration).
- d) Areas of deck that are included in the deck area measurement and overhang beyond the extremities of the hull shall be included in the measurement of length overall.

NOTE: Further guidance on the location of the foremost part of the hull is given in Figure A.1.

**after part of the hull—**

the point of intersection of the trailing edge of the shell plating, planking or other structural material with the upper side of the uppermost weathertight deck or, in the case of an open vessel, at the height of the gunwale. In the case of stern bars or posts, the point of intersection lies where the outside of the shell plating or planking meets with the stern bar or post. Members added to the exterior of the hull shall be excluded, e.g. fender, sponson, rubbing strip, etc.

NOTE: Further guidance on the location of the after part of the hull is given in Figure A.2.

**aftermost part of the hull—**

the most aft point of the vessel. In all cases the following applies:

- a) Members added to the vessel and not forming part of the structure of the vessel shall be excluded, e.g. rudders; outboard motor brackets; non-buoyant swim platforms; fenders; pushpit rails; stern door or ramp; sponsons; rubbing strip; sternsprits; bumpkins; etc.
- b) Bulwarks shall be taken as part of the vessel.
- c) Integrally formed, welded or moulded components and other appendages that provide buoyancy shall be included in the measurement of length overall including integral pods and integral swim platforms.
- d) Areas of deck that are included in the deck area measurement and overhang beyond the extremities of the hull shall be included in the measurement of length overall.

NOTE: Further guidance on the location of the aftermost part of the hull is given in Figure A.2.

**weathertight deck—**

the uppermost complete deck (which may be stepped) exposed to the weather and sea that has permanent means of closing all openings in the part exposed to the weather and sea and below which all openings in the sides of the vessel are fitted with permanent means of watertight closing.

**height of gunwale—**

the vertical distance from the weather deck to the edge of the fore and aft member which is fitted around the inside of the vessel at the top of the side shell plating, planking or other structural material.

**A5 ILLUSTRATIONS**

As a further guide to the interpretation of length overall and length on deck, reference shall be made to Figure A.3.

**A6 METHODS FOR MEASURING****A6.1 Measuring an existing vessel**

Measurement should, wherever possible, be taken in a direct line parallel to the design fully loaded waterline between the two defined extremities.

**A6.1.1 Vessel afloat or on shore**

On an existing vessel measurement would normally be undertaken by setting up sight boards at the stem and stern, together with as many intermediate sights as are necessary to circumvent obstructions or breaks in the uppermost weathertight deck. Figure A.4(a) illustrates the method.

**A6.1.2 Alternative method for vessel on shore**

For a vessel that is out of the water, measurement may be undertaken by setting up plumb lines dropped from the defined extremities. Where the lengths are measured with the design-laden waterline not horizontal, the measurement should be corrected for the difference in declivity. Figure A.4 (b) illustrates the application of the method on a vessel that is located on a steeply angled slipway.

**A6.1.3 Approximate methods for vessel afloat or on shore**

The following approximate methods for measuring length may be used where the measurement of length is not critical to determining applicable criteria.

**Method 1**

The length method may be taken along a straight line between the reference points fore and aft. Where sight boards or plumb lines are used, care shall be taken to ensure that the measurement is taken between points on the sight boards or plumb lines which are equidistant from the reference points (i.e. the top of deck or gunwale). The measurement obtained from this method may be in excess of the true method, especially where the height of the fore and aft reference points above the design waterline differs significantly. Refer to Figure A.5(a).

**Method 2**

The length measurement may be taken by means of a tape laid along the deck or decks. The measurement obtained from this method may be in excess of the true measurement due to the curvature of the deck. Refer to Figure A.5.

In most cases this increase in length will be of little concern; however, if the measurement is critical, the length shall be checked by either of the two methods described in Clauses A6.1.1 and A6.1.2.

**A7 UNUSUAL VESSELS**

Where the physical characteristics of a vessel are such as to render the definitions in Clause A4 unclear or inappropriate, the measurement shall be interpreted so as to result in a value of measured length that is appropriate to the actual risks associated with the vessel, as compared to other vessels of similar size and service.

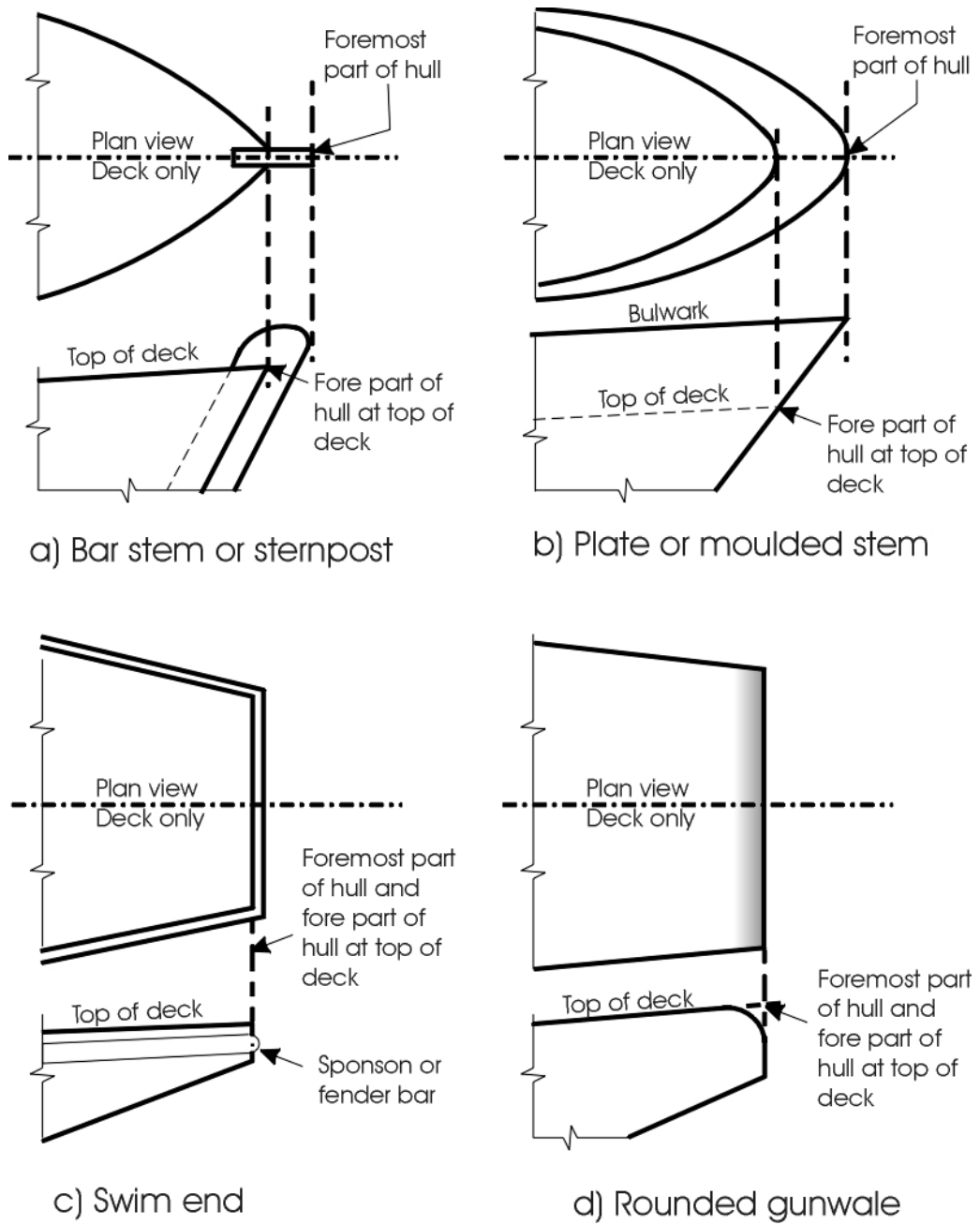

**Figure A.1 — Reference points at the fore end of a vessel**

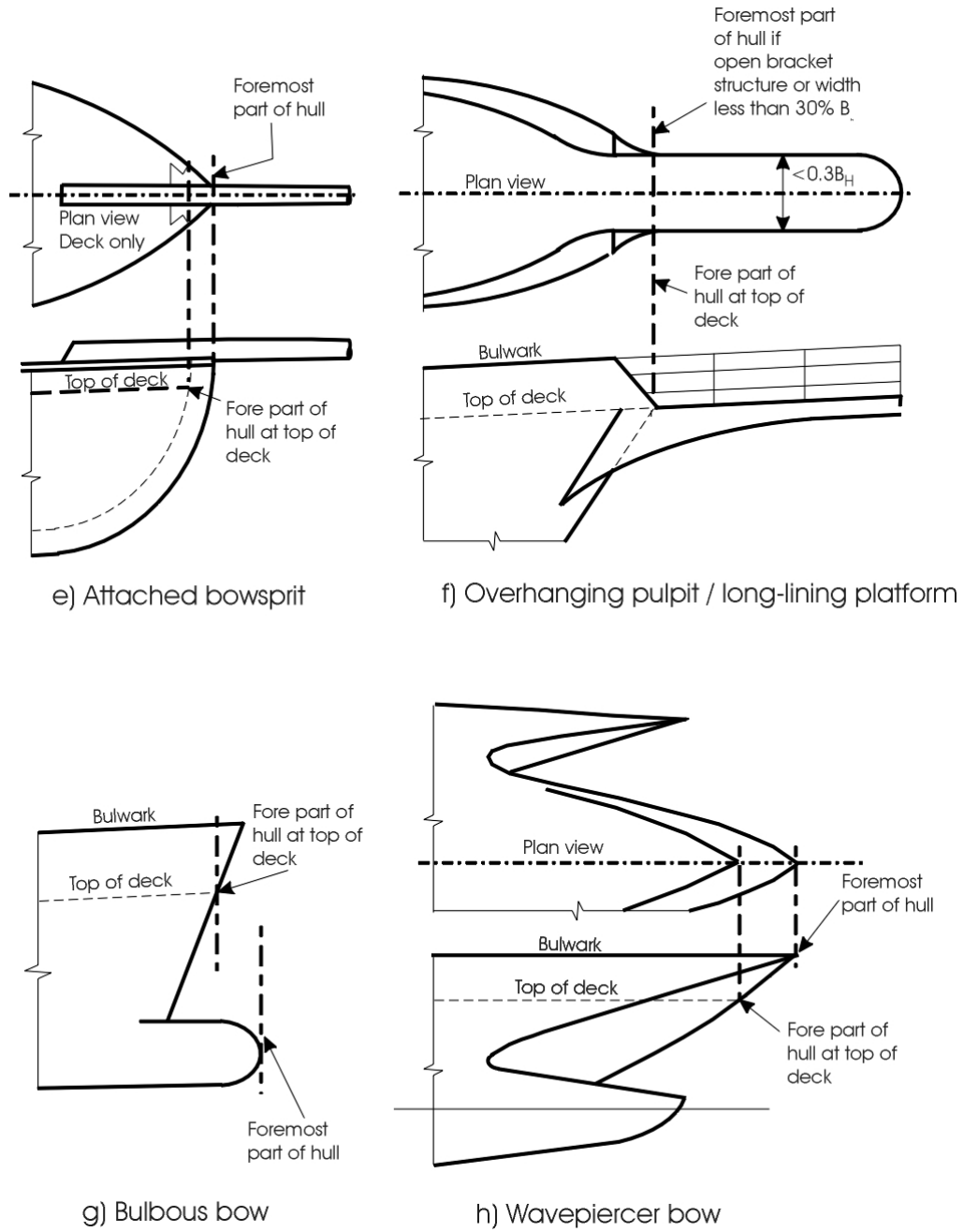
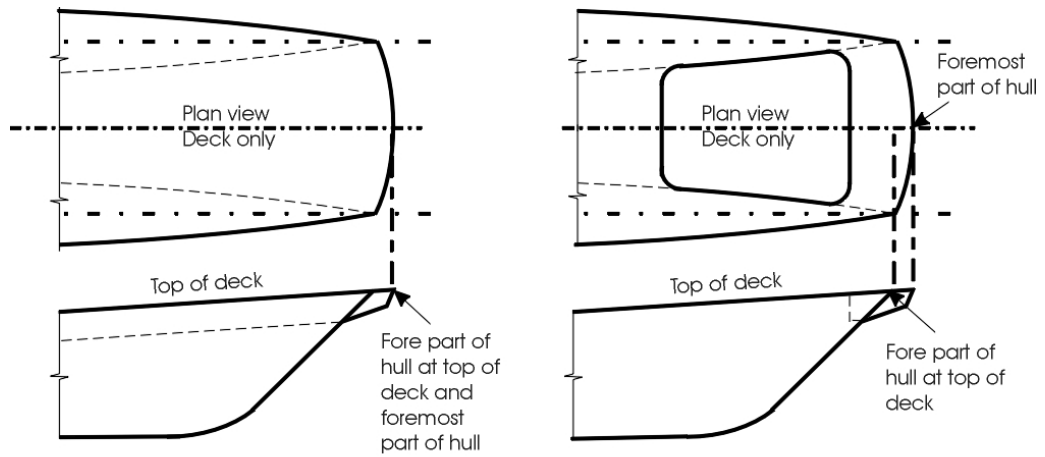

Figure A.1 (continued)





i) Catamaran with buoyant bridging deck or overhanging deck included in deck areas

j) Catamaran with bridging beam not intended for the carriage of persons

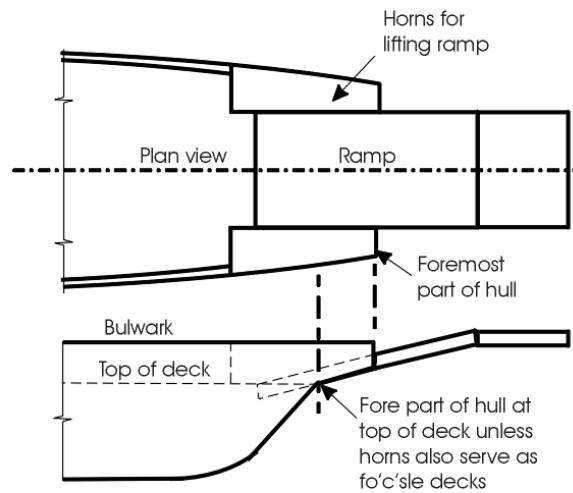

k) Overhanging ramp on landing barges and vehicular ferries

Figure A.1 (continued)

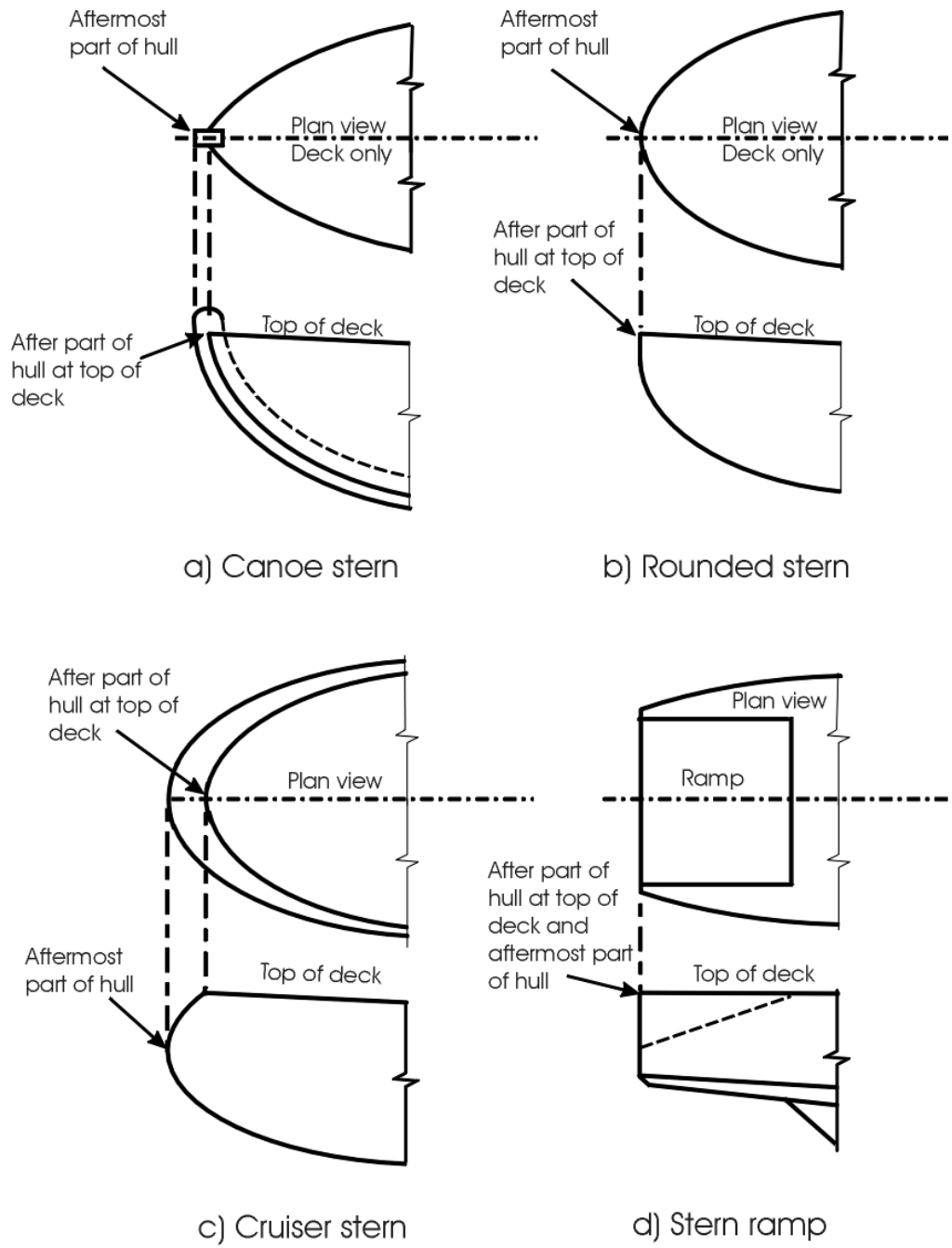

Figure A.2 — Reference points at aft end of a vessel

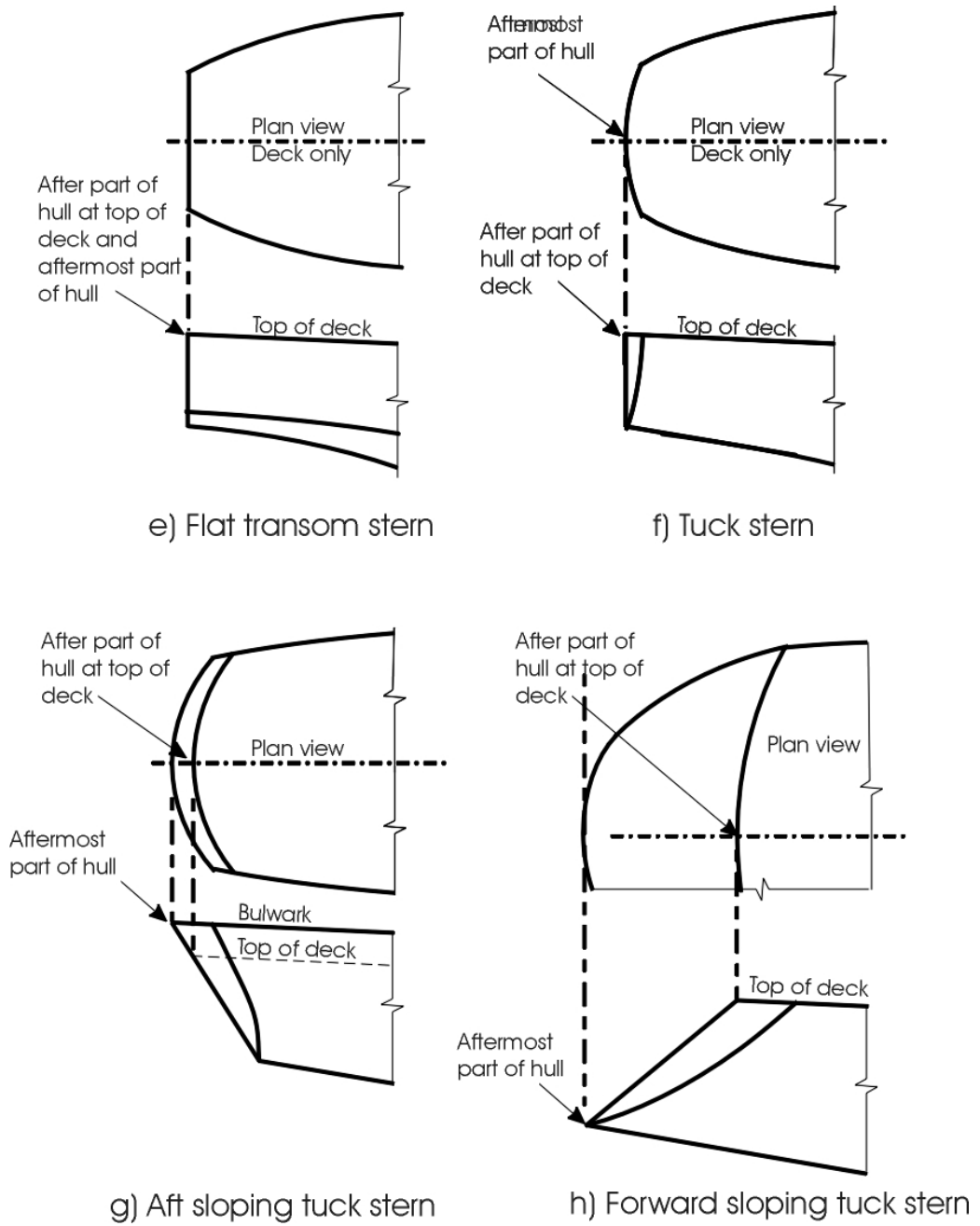

Figure A.2 (continued)

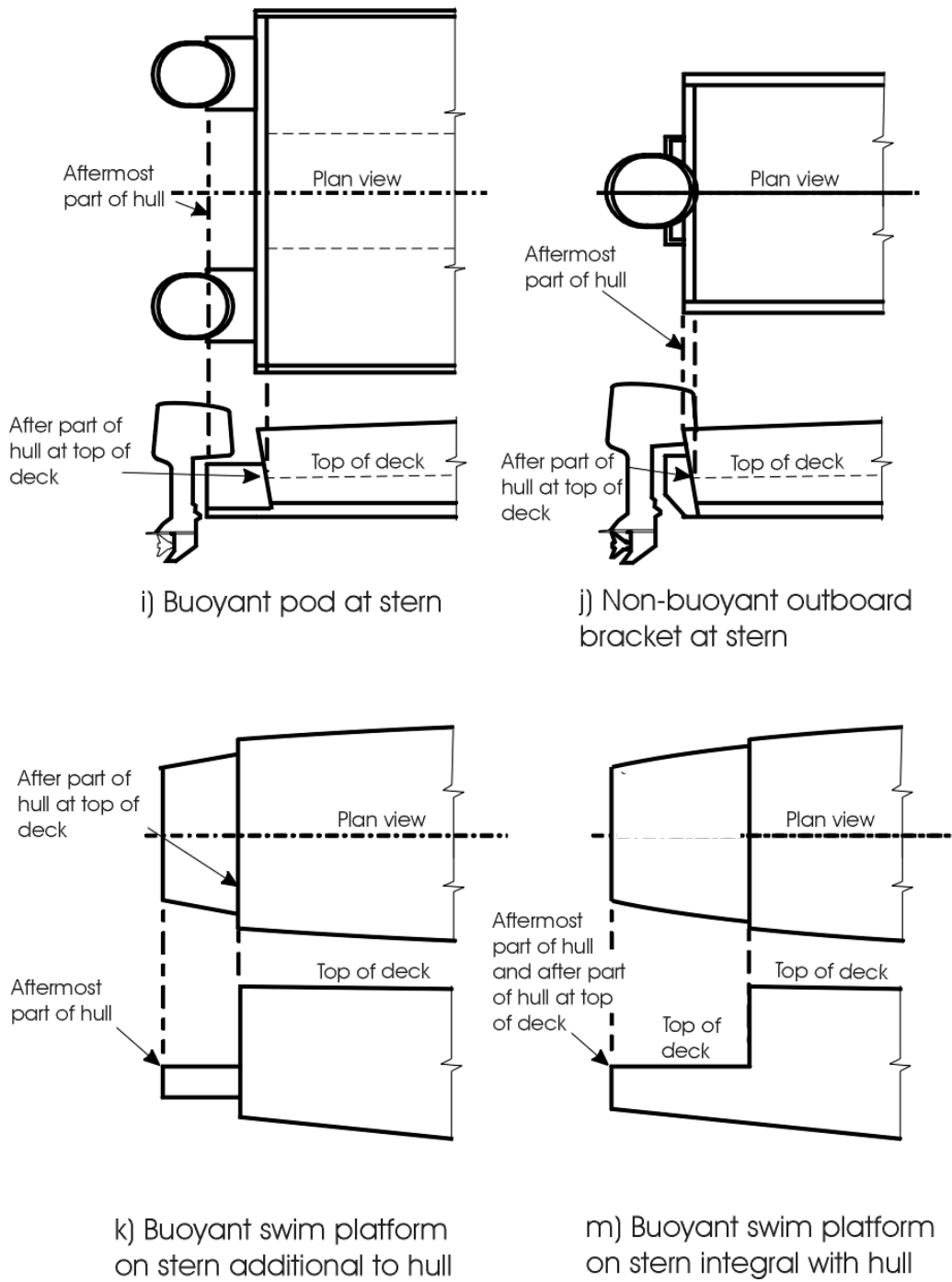
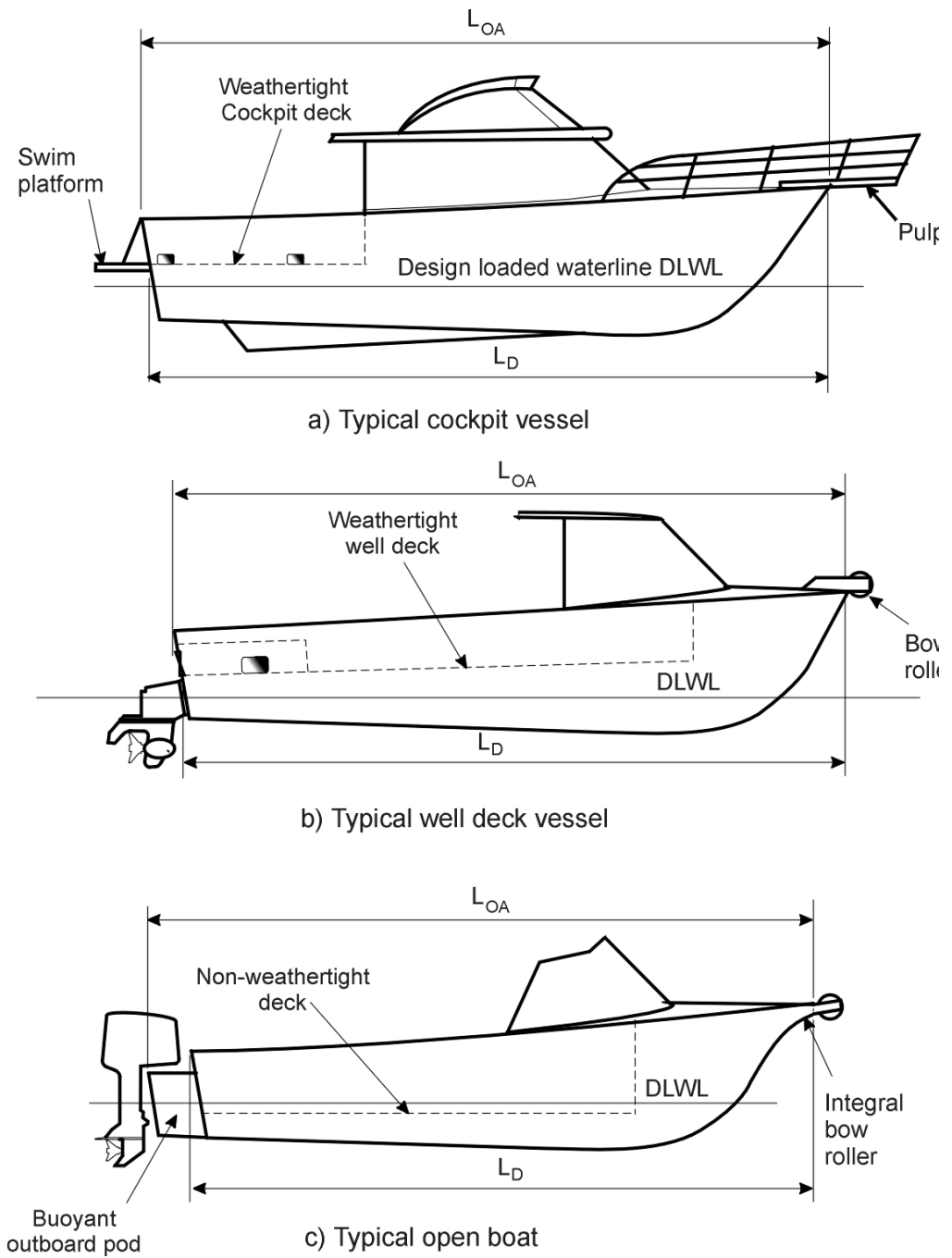
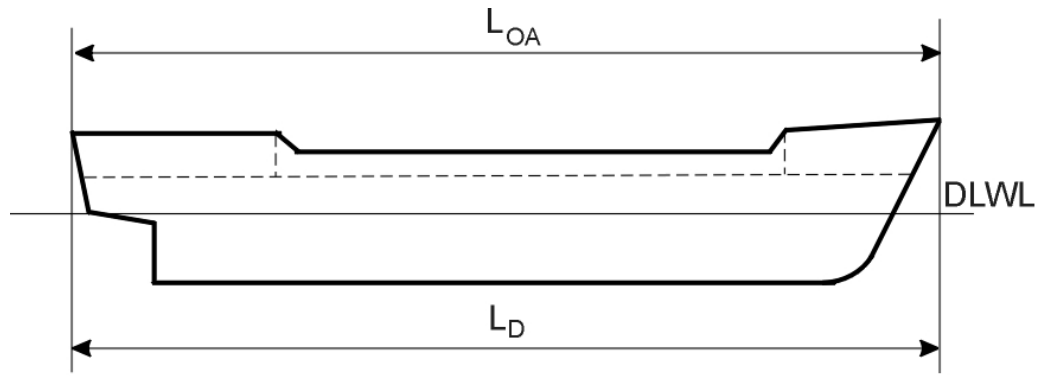

Figure A.2 (continued)



**Figure A.3 — Guidance on measuring length**



d) Raised fo'c'sle and poop deck

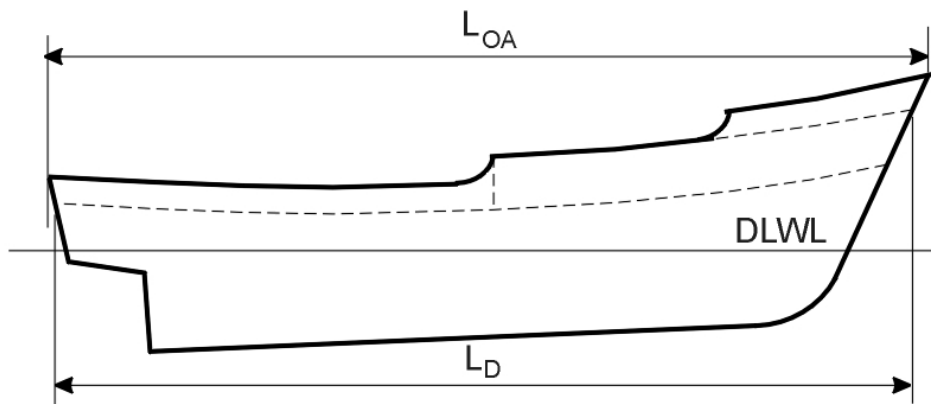

e) Overhang of solid bulwarks

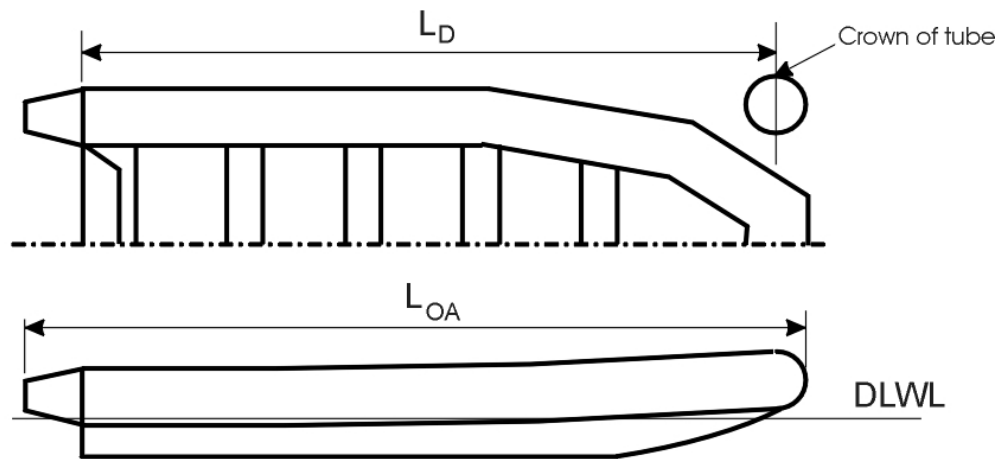

f) RIB or Inflatable

Figure A.3 (continued)

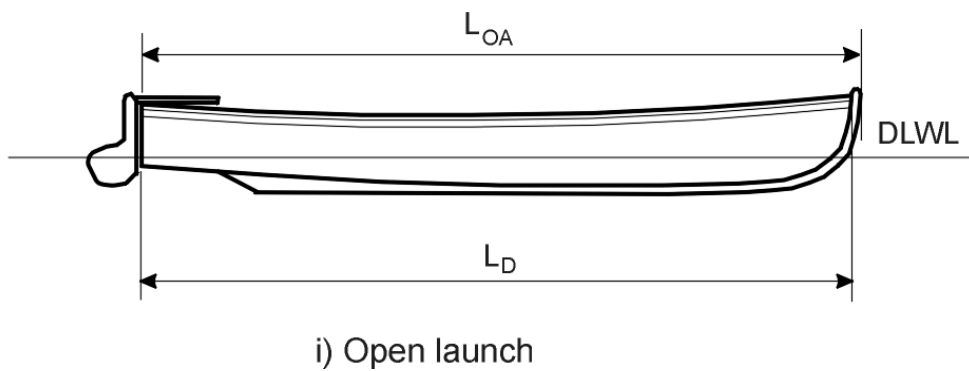
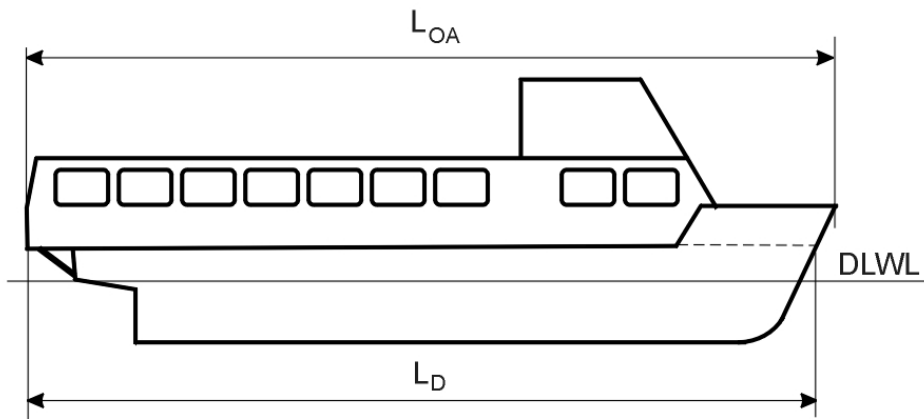
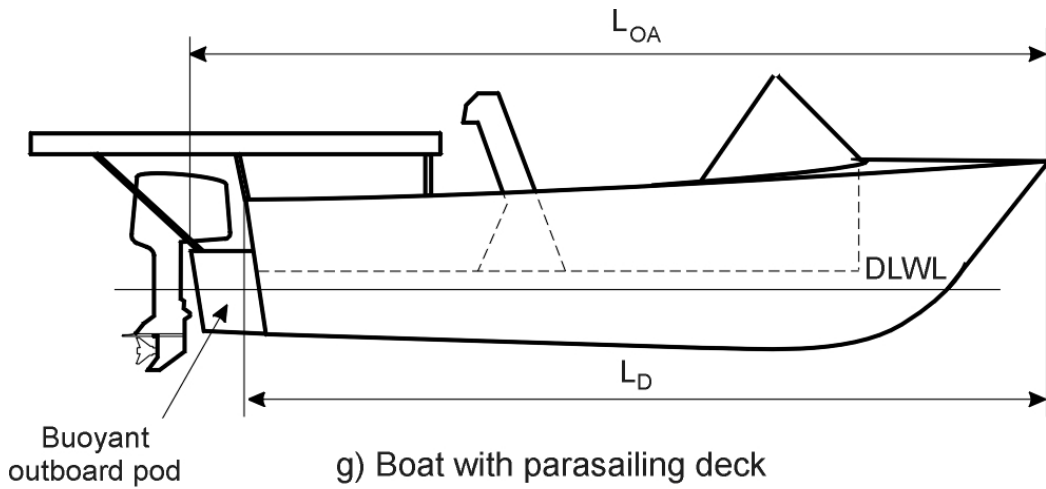

**Figure A.3** (continued)

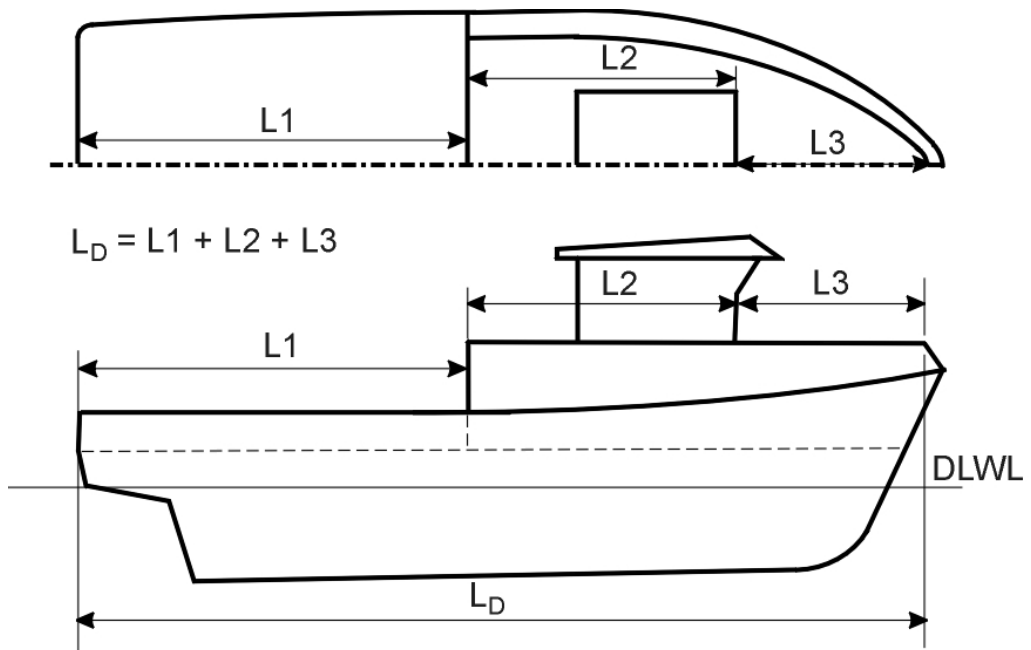

a) Measurement using sight boards ashore or afloat

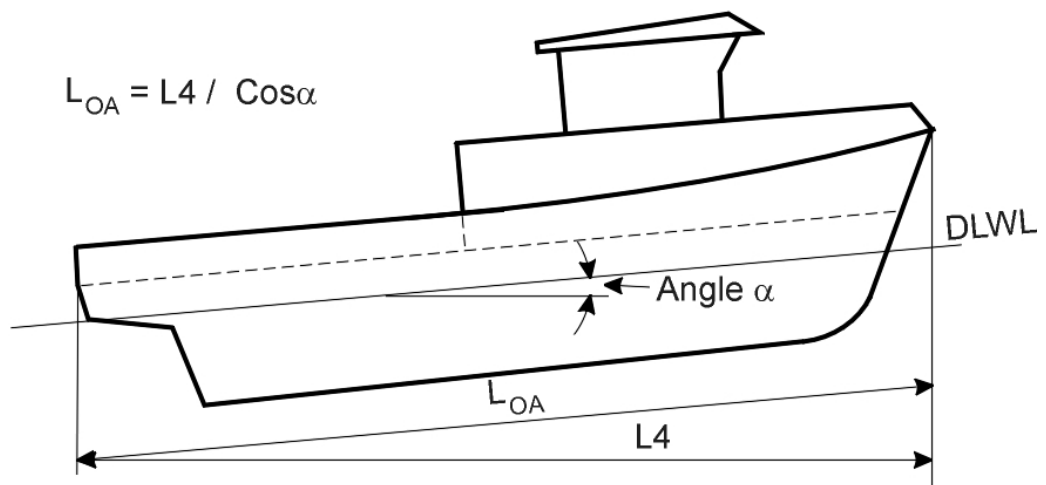

b) Measurement on-shore using plumb-bobs

Figure A.4 — Methods for measuring length



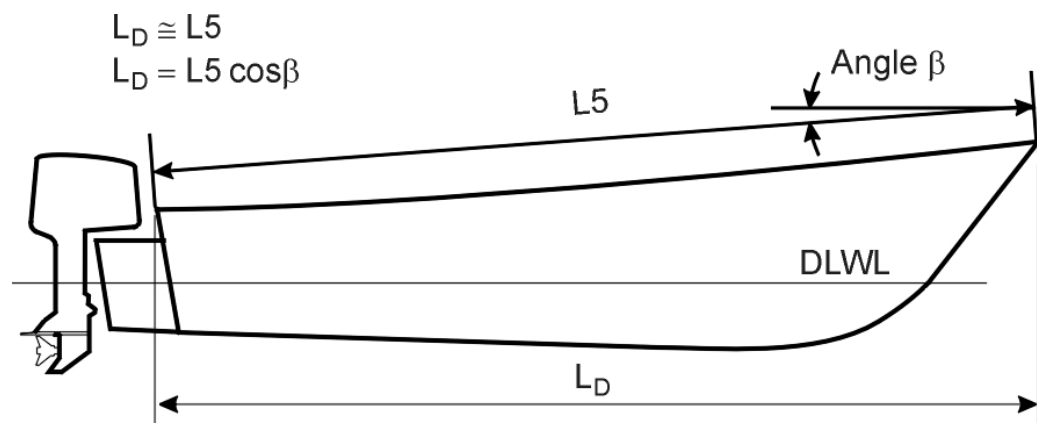

a) Approximate method 1

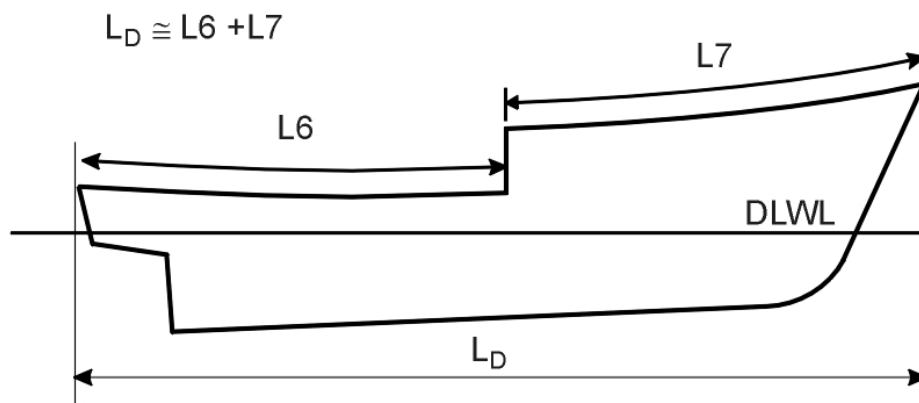

b) Approximate method 2

**Figure A.5 — Approximate methods for measuring length**

## ANNEX B GUIDANCE ON HAZARD IDENTIFICATION, RISK ASSESSMENT AND CONTROL OF RISK

### B1 SCOPE

This Annex B gives guidance on hazard identification, risk assessment and control of risk for vessels for the purpose of fulfilling safety obligations described under Part A, and assessing solutions under Clause 2.7.3 above. It forms an informative part of this document, unless designated as mandatory by the Authority.

### B2 APPLICATION

This Annex applies to new and existing vessels. The hazards identified in Clause B3.2 are not exhaustive in that they do not cover every type of vessel, operation, or risk.

### B3 HAZARD IDENTIFICATION

#### B3.1 Reasonably foreseeable hazards to be identified

All reasonably foreseeable hazards to health and safety arising from a vessel and systems of work associated with the vessel should be identified.

#### B3.2 Typical factors pertaining to hazards on vessels

Without limiting the generality of Clause B3.1, hazards associated with the following factors so far as they are relevant to the design, construction, commissioning and use of the vessel, should be identified:

- a) Suitability of the type of vessel for the particular service.
- b) Characteristics of the actual and intended areas of operation including: navigational hazards; sea and wind states; traffic; rescue facilities; availability of shelter; weather forecasting; maintenance facilities; berthing facilities.
- c) Characteristics of the actual and intended use of a vessel, e.g. carriage of dangerous cargoes, high-speed operations, special loading facilities, use by a wide cross-section of the community, rescue capability.
- d) Foreseeable abnormal situations, misuse and fluctuation of operating conditions.
- e) Potential for personal injury due to: entanglement; crushing; trapping; cutting; stabbing; puncturing; shearing; abrasion; tearing; and stretching.
- f) Generation of hazardous conditions due to: pressurised content; electricity; noise; vibration; fire; smoke; explosion; temperature; moisture; vapour; gases; dust; ice; hot or cold parts.
- g) Failure of machinery or engineering systems on a vessel resulting in: the loss of the watertight integrity; loss of control and manoeuvrability; fire; explosion; loss of emergency systems; evacuation.

- h) Failure of the structure by: yield; buckling; ultimate failure or fatigue resulting in the loss of watertight integrity; structural collapse under load; loss of emergency systems; effect on evacuation.
- i) Unsuitability of materials or fabrication methods used in the construction of a vessel; and the effects of corrosion, fatigue, electro-compatibility, impact, overstressing and watertight integrity.
- j) Collision or grounding of the vessel resulting in: loss of watertight integrity; loss of stability; loss of emergency systems; need for evacuation.
- k) Failure of closing appliances on the vessel through the force of the sea resulting in: loss of watertight integrity; loss of stability; loss of emergency systems; need for evacuation.
- l) Uncontrollable fire resulting in: flame; heat; smoke and toxic fumes; loss of emergency systems; need for evacuation.
- m) Inadequate arrangements for access, egress and escape from within the vessel or from the vessel itself resulting in personal injuries in normal conditions and injuries and potential loss of life in emergency conditions.
- n) Inadequate arrangements for seating or berthing resulting in personal injuries in normal or abnormal conditions of operation.
- o) Operator error arising from lack of competency (skill and knowledge), fatigue, inadequate systems of work, inadequate information and feedback.
- p) Inability of the safety system to forgive operator error.
- q) Failure of control, monitoring or communication systems resulting in: loss of control; loss of manoeuvrability; mechanical failure; failure to identify and respond quickly to an emergency; failure of emergency systems.
- r) Loss of stability arising from: improper loading; excessive heeling moments (wind, passenger, crane, fishing, etc.); dynamic effects of a seaway; breach of watertight integrity.
- s) Ergonomic needs relating to use.
- t) Hazards arising during and after evacuation including: personal injury during disembarkation; exposure; hypothermia; drowning; starvation; thirst.

## **B4 RISK ASSESSMENT**

### **B4.1 Risks to be assessed**

Where a hazard is identified under Clause B3, an assessment of risks associated with that hazard should be made.

### **B4.2 Method of risk assessment**

A person carrying out a risk assessment under Clause B4.1 should, as far as practicable, determine a method of assessment that adequately addresses the hazards identified, and includes one, or a combination of the following:

- a) A visual inspection of the vessel and its associated environment.
- b) Auditing.
- c) Testing.
- d) A technical or scientific evaluation.
- e) An analysis of injury and near-miss data.
- f) Discussions with designers, builders, suppliers, owners, employers, employees, and other relevant parties.
- g) A quantitative risk analysis.
- h) Professional judgement with or without a qualitative risk analysis.

## **B5 CONTROL OF RISK**

### **B5.1 Risk to be eliminated or controlled**

Where an assessment under Clause B4 identifies a requirement to control a risk to health or safety, that risk should be eliminated or, where it cannot be eliminated, controlled to an acceptable level.

### **B5.2 Approaches to controlling risk**

To reduce the risk to health and safety, one or a combination of the following approaches should be used:

- a) Modification of the design of the vessel.
- b) Modification of the operational limits imposed on a vessel.
- c) Engineering controls such as fail-safe mechanisms, redundancy, duplication, guarding.

### **B5.3 Administrative alternatives**

Where through the application of Clause B5.2 the risk cannot be reduced to an acceptable level, appropriate administrative controls (including changes to the system of work), training and personal protective equipment should be used.

### **B5.4 Vessel unsuitable**

Where through the application of Clauses B5.2 and B5.3 the risk still cannot be reduced to an acceptable level, then the vessel may be unsuited for the intended operation. In such cases, the risk should be reduced by substituting the vessel with a less hazardous type of vessel; or finding employment for the vessel that is less hazardous.

### **B5.5 Access/egress**

There should be sufficient access and egress to each of the following:

- a) The vessel itself, having regard to the demographic characteristics of persons on board, including access for the disabled, where appropriate.

- b) Public spaces in both normal and abnormal conditions, having regard to the demographic characteristics of persons on board, including access for the disabled, where appropriate.
- c) Assembly and evacuation stations.
- d) Parts of a vessel that require inspection, cleaning and maintenance.
- e) Spaces normally or potentially manned by members of the crew, and control stations in both normal and abnormal conditions.

#### **B5.6 Enclosed spaces**

Where access to enclosed spaces in a vessel is required as part of normal operation, and persons may become entrapped exposing them to increased risk due to heat, cold or lack of oxygen, then the following should be provided:

- a) Emergency lighting.
- b) Means of opening the door from both sides.
- c) Alarm systems.

#### **B5.7 Dangerous areas**

Where an assessment under Clause B4 identifies a risk of exposure to areas that are or become dangerous during operation, examination, lubrication, adjustment or maintenance, that risk should be eliminated or, where it cannot be eliminated, controlled to an acceptable level.

#### **B5.8 Guarding**

##### **B5.8.1 Arrangement**

Where guarding is used as a control measure, a person with the responsibility for the control of risk should ensure that the arrangements for guarding are appropriate for the particular application. In particular—

- a) where no part of a person requires access to the dangerous area during normal operation, maintenance or cleaning, any guard provided is a permanently fixed barrier;
- b) where access to dangerous areas is required during the operating sequence, any guard provided is an interlocked physical barrier;
- c) where a guard in accordance with Clause B5.8.1 a) or b) is not practicable, that it is a physical barrier securely fixed in position by means of fasteners or other suitable devices, which ensures that the guard cannot be altered or detached without the aid of a tool or key; and
- d) where a guard in accordance with Clause B5.8.1 a), b) or c) is not practicable, that presence-sensing safeguarding systems are provided.

##### **B5.8.2 Additional requirements**

Where guards are used in accordance with Clause B5.8.1, they should be—

- a) designed and constructed to make by-passing or defeating them, whether deliberately or by accident, as difficult as is reasonably possible;
- b) of solid construction and securely mounted so as to resist impact and shock;
- c) regularly maintained; and
- d) designed so as not to cause a risk in themselves.

## **B6 RECOMMENDED FORMAT FOR DOCUMENTING HAZARDS, RISKS AND OPTIONS FOR CONTROLLING RISK**

### **B6.1 Tables**

Table B.1 and Table B.2 provide a convenient format for identifying hazards and analysing risks and the options for controlling risk.

### **B6.2 Acceptable risk**

When using these tables, decisions need to be made as to whether a risk is acceptable or unacceptable. Guidance on what constitutes an acceptable or unacceptable risk is provided in Annex C below.

### **B6.3 Risk management process**

AS/NZS 4360 provides a detailed and structured approach to the whole risk management process including its context within the management of an organisation. The management of a vessel, and those responsible for the design and construction of a vessel are encouraged to adopt risk management strategies such as those presented in AS/NZS 4360.

**Table B.1 — Risk register**

REF	THE HAZARD	THE CONSEQUENCES OF A HAZARD HAPPENING WITHOUT CONTROLS		EXISTING CONTROLS	THE CONSEQUENCES OF A HAZARD HAPPENING WITH EXISTING CONTROLS		LEVEL OF RISK	RISK PRIORITY
	What can happen and how it can happen	Likelihood Rating	Consequence Rating		Likelihood Rating	Consequence Rating		

Table B.2 — Risk treatment options

REF	RISK	PRIORITY	POSSIBLE TREATMENT OPTIONS	PREFERRED OPTION	RISK RATING AFTER TREATMENT	COST/BENEFIT ANALYSIS RESULT
			1. 2. 3.			



---

## ANNEX C GUIDANCE ON ACCEPTABLE RISK

### C1 SCOPE

This Annex C gives guidance on what constitutes acceptable risk on a vessel for the purpose of fulfilling safety obligations described under Part A, and assessing solutions under Clause 2.7.3 above. It forms an informative part of this document, unless designated as mandatory by the Authority.

### C2 APPLICATION

This Annex applies to new and existing vessels.

### C3 DESIRED OUTCOME

For the purposes of a risk management analysis of a vessel, the probability of serious injury to personnel should be very remote and the probability of deaths should be improbable.

### C4 NATURE OF RISK

Risk is a function of likelihood and consequence.

### C5 LIKELIHOOD

The various levels of hazard likelihood are as follows<sup>3</sup>:

**frequent—**

where an occurrence is likely to occur often during the operational life of a particular vessel (probability more than  $10^{-3}$  per hour or per journey, whichever is the lesser period of time).

**reasonably probable—**

where an occurrence is unlikely to occur often but which may occur several times during the total operational life of a particular vessel (probability between  $10^{-3}$  and  $10^{-5}$  per hour or per journey, whichever is the lesser period of time).

**remote—**

where an occurrence is unlikely to occur to every vessel but may occur to a few vessels of a type over the total operational life of a number of vessels of the same type (probability between  $10^{-5}$  and  $10^{-7}$  per hour or per journey, whichever is the lesser period of time).

**very remote—**

where an occurrence is unlikely to occur when considering the total operational life of a number of vessels of the type, but nevertheless should be considered as being possible (probability between  $10^{-7}$  and  $10^{-9}$  per hour or per journey, whichever is the lesser period of time).

---

<sup>3</sup> Adapter from HSC Code Annex 3 Clauses 2.2.1 to 2.2.6

**improbable—**

where an occurrence is so extremely remote that it should not be considered as possible to occur (probability less than  $10^{-9}$  per hour or per journey, whichever is the lesser period of time).

**C6 CONSEQUENCE**

The various levels of hazard consequence are as follows<sup>4</sup>:

**minor—**

an effect which can be readily compensated for by the operating crew. It may involve one or more of the following:

- a) A small increase in the operational duties of the crew or in their difficulty in performing their duties.
- b) A moderate degradation in handling characteristics.
- c) Slight modification of the permissible operating conditions.

**major—**

an effect which produces one or more of the following:

- a) A significant increase in the operational duties of the crew or in their difficulty in performing their duties which by itself should not be outside the capability of a competent crew provided that another major effect does not occur at the same time.
- b) Significant degradation in handling characteristics.
- c) Significant modification of the permissible operating conditions, but will not remove the capability to complete a safe journey without demanding more than the normal skill on the part of the operating crew.

**hazardous—**

an effect which produces one or more of the following:

- a) A dangerous increase in the operational duties of the crew or in their difficulty in performing these duties of such magnitude that they cannot reasonably be expected to cope with them and will probably require outside assistance.
- b) Dangerous degradation of handling characteristics.
- c) Dangerous degradation of the strength of the vessel.
- d) Marginal or actual conditions for, or injury to, occupants.
- e) An essential need for outside rescue operations.

**catastrophic—**

an effect which results in the loss of the vessel and/or fatalities.

---

<sup>4</sup> HSC Code Annex 3 Clauses 2.3.2 to 2.3.5

**C7 ACCEPTABLE AND UNACCEPTABLE LEVELS OF RISK**

Relative levels of risk are determined by considering the likelihood of occurrence against the severity of the consequences. An assessment is made to determine whether particular combinations of likelihood and consequence are a negligible, tolerable or intolerable risk<sup>5</sup>.

**intolerable risk—**

the presence of the hazard in the system or situation cannot be justified and the risk level must be reduced. An intolerable risk would almost certainly be unacceptable. If it is impossible to achieve risk reduction cost-effectively, serious consideration should be given to abandoning the project, activity or system for another option.

**tolerable risk—**

the hazards in the system or situation will probably give rise to accidents, but that the frequency and nature of the consequences could probably be tolerated. However, there is still some degree of uncertainty in the analysis. If it is possible to reduce the risk levels cost-effectively, then an effort should be made to do so, particularly for hazards that fall just below the intolerable threshold. A tolerable risk may or may not be acceptable depending upon the effort that might be required to further reduce the risk compared to the benefits of doing so.

To determine whether a tolerable risk is acceptable:

*The methods of reducing the risk level of a hazard can be put in one scale and balanced against the effort needed in another. This effort may be represented by money, time, or a combination of the two. If it can be shown that there is a gross imbalance between the two; e.g., the reduction in risk level is insignificant compared with the cost of implementing the proposed solution, it would not be reasonably practicable to go ahead.*<sup>6</sup>

**negligible risk—**

means the hazards in the system or situation are most unlikely to lead to accidents and no effort need be expended to reduce their risk levels. A negligible risk would normally be acceptable.

---

<sup>5</sup> Kuo, Chengi, Dr. *Managing Ship Safety*. London. 1998. p.65 & p.80

<sup>6</sup> UK Health and Safety Executive. *The Tolerability of Risk from Nuclear Power Stations*. 1992.

**C8 EXAMPLE**

A typical table resulting from such an analysis is provided in Table C.1<sup>7</sup>. In this analysis, intolerable risks are unacceptable. Tolerable and negligible risks are acceptable. This is consistent with the objectives stated in Clause C3 of this Appendix.

---

<sup>7</sup> Bottom of Table 2 in HSC Code Annex 3

**Table C.1—Level of risk for given combinations of likelihood and consequence**

	<b>IMPROBABLE</b>	<b>VERY REMOTE</b>	<b>REMOTE</b>	<b>REASONABLY PROBABLE</b>	<b>FREQUENT</b>
<b>MINOR</b>	NEGLIGIBLE	NEGLIGIBLE	NEGLIGIBLE	TOLERABLE	TOLERABLE
<b>MAJOR</b>	NEGLIGIBLE	NEGLIGIBLE	TOLERABLE	TOLERABLE	INTOLERABLE
<b>HAZARDOUS</b>	NEGLIGIBLE	TOLERABLE	INTOLERABLE	INTOLERABLE	INTOLERABLE
<b>CATASTROPHIC</b>	TOLERABLE	INTOLERABLE	INTOLERABLE	INTOLERABLE	INTOLERABLE

## ANNEX D      GUIDANCE ON THE PREPARATION OF INFORMATION AND PLANS FOR VESSELS

### D1      SCOPE

This Annex gives guidance on the preparation of information and plans for vessels. It forms an informative part of this document, unless designated as mandatory by the Authority.

### D2      APPLICATION

This Annex applies to new and existing vessels entering survey for the first time, existing vessels intending to upgrade service and existing vessels intending to be altered.

NOTE: For vessels operating within the jurisdiction of one Authority while under the survey of another Authority and vessels intending to transfer a current survey to another Authority, refer to The National Marine Guidance Manual—Administrative Protocol for the Mutual Recognition of Vessel Certificates of Survey.

### D3      PRELIMINARY INFORMATION

When a vessel is to be built or an existing vessel is to be put into survey for the first time, upgraded or altered, the owner or intending owner should contact the Authority as early as possible. The basic information necessary for the Authority to provide an initial assessment is as follows:

- a) Vessel identification, e.g. name or construction number, if any.
- b) Name of owner or intending owner.
- c) Hull construction material.
- d) Principal dimensions of vessel.
- e) Nature of the service in which the vessel will be engaged.
- f) Intended area of operations of the vessel.
- g) Gross tonnage or estimated lower and upper limits of gross tonnage.
- h) Whether the vessel is to be classed or is classed and if so the name of the Classification Society and details of the Classification.
- i) Whether the vessel will hold or holds a Load Line Certificate and/or Cargo Ship Safety Construction Certificate issued by a Classification Society.
- j) Whether the vessel, being an existing vessel, holds or has held any other certificates relating to survey and if so the type of each certificate, its date of expiry and the name of the authority who issued the certificate.

NOTE: The owner is normally required to supply the above information as part of the process of completing an Application for Initial Survey. Fees are usually payable with the Application for Initial Survey.

## D4 INFORMATION AND PLANS

### D4.1 Purpose

Information and plans are normally required to verify that the vessel complies with applicable standards, to verify that those standards are maintained over time and to provide important safety information to persons responsible for the safety of the vessel.

NOTE: Plans may not be required for some smaller vessels. Further advice can be obtained by contacting the relevant Authority.

### D4.2 Format

Information and plans should facilitate their ready use for verification of compliance with standards. They should therefore be—

- a) an accurate representation of the vessel and its components in their intended form;
- b) sufficient in detail to ensure that all the relevant requirements have been incorporated in the design;
- c) legible;
- d) in the English language;
- e) if a plan, to an appropriate scale to permit accurate and efficient scaling directly from the drawing (for example: 1:1, 1:2, 1:5, 1:10, 1:20, 1:25, 1:50, 1:75, 1:100, etc);
- f) wherever possible, prepared in accordance with applicable standards such as those given in Table D.1; and
- g) of sufficient number of copies to permit the retention of at least one copy by the Authority.

NOTE: The Authority will advise on the number of copies of information and plans.

**Table D.1 — Standards applicable to the preparation of drawings**

Designation	Title
AS 1100	Technical drawing (all parts)
AS 1101	Graphic symbols for general engineering (all parts)
AS 1102	Graphical symbols for electrotechnical documentation (all parts)
AS 1266	Fire control plans for ships
AS/NZS 4383	Preparation of documents used in electrotechnology
ISO 128	Technical drawings - General principles of presentation
ISO 129	Technical drawings; Dimensioning; General principles, definitions, methods of execution and special indications
ISO 406	Technical drawings; Tolerancing of linear and angular dimensions
ISO 3098-1	Technical drawings; lettering; part 1: currently used characters

ISO 7000	Graphical symbols for use on equipment - Index and synopsis
----------	---

### D4.3 Amendments

Where a design is amended subsequent to an initial submission, every plan, specification, etc. affected by the alteration should be amended accordingly and the date of amendment recorded. Revised copies should be forwarded immediately to the Authority.

### D4.4 Content of information and plans

The extent and content of the information and plans needed to verify compliance with standards will be dependent on categorization, size and type of vessel. Table D.2 may be used as a general guide:

**Table D.2 — Content of information and plans**

Item	Description of content	Typical application
General arrangement plans	Tanks, deck openings, seating, berths, bulkheads, access ways, bulwarks and railings, navigation lights, ventilation openings, ballast, buoyancy material, use of each space, watertight closing appliances, life-saving appliances	All vessels
Construction plans and/or specifications	Transverse and longitudinal sections, bulkheads, decks, superstructure, deckhouses, engine girders, scantlings, material details, fastening/welding/layup details, windows and window frames	All vessels
Lines plan	Body plan, sheer plan, draft marks and location of watertight bulkheads	All vessels with comprehensive stability or subdivision
Plans or specifications for closing devices	Construction and means for securing watertight or weathertight openings liable to downflooding	All vessels
Piping schematics	Essential and high risk systems including bilge, fuel, sanitary, engine exhaust, refrigeration and steam; showing valves, vents, overflows, filling stations, pipe materials, diameters and wall thicknesses	All vessels
Fire protection	Type and disposition of fire divisions, fire-extinguishing appliances, location of escapes	Vessels of 12.5 m length and more
Rudder and steering gear plan	Rudder, rudder stock, bearings, coupling, steering gear and alternative method of steering	All vessels
Shafting plan	Propeller shaft, bearings and couplings, stern tube, propeller brackets, engine and thrust seatings	All vessels
Construction schedule	Time schedule for building, laminating and welding to determine key milestones for inspections	All vessels
Electrical schematic	Electrical equipment and wiring, protection devices (overload, low voltage), emergency power arrangements	32 Volts and more, or vessels required to fit emergency power arrangements
Sail plan	Location and size of sails and underwater profile of vessel	Sailing vessels
Machinery arrangement	Arrangement and function of main and auxiliary machinery (may be incorporated on general arrangement plan)	All vessels



Freestanding fuel tanks	Construction, material details, scantlings, baffles, support	Vessels with freestanding fuel tanks
Damage control plan	Boundaries of watertight compartments, openings and means for closure, arrangements for correcting list	Vessels 35 m and more and passenger vessels 25 m and more

(continued...)

**Table D.2 (continued)**

<b>Item</b>	<b>Description of content</b>	<b>Typical application</b>
Fire control plan	Location and type of active and passive fire safety systems on board the vessel, control stations, location of divisions, fire alarms, fire detection and extinguishing systems, fire-extinguishing appliances, access to compartments and decks, ventilating systems, location of international shore connection if fitted, fire suits, breathing apparatus	Vessels 35 m and more and passenger vessels 25 m and more
Emergency plan	Assembly stations, signals, escape routes, evacuation routes, location of life saving equipment, flares, EPIRB, lifebuoys, immersion suits. On vessels of length less than 50 metres, the damage control, fire and emergency plans may be combined in a single drawing	Vessels 35 m and more and passenger vessels 25 m and more
Intact stability	Particulars of vessel, information in accordance with Part C Subsection 6A	All vessels subject to intact stability criteria
Damaged stability	Calculations and information showing the nature of damaged stability criteria and the vessel's compliance with those criteria	All vessels subject to damaged stability criteria
Manuals	Operating, maintenance and training manuals	Fast Craft
Failure mode and effect analysis	Essential machinery and systems	Fast Craft

NOTE: Some of these plans and information may not be needed for smaller vessels. Further advice can be obtained by contacting the relevant Authority.