

Australian Transport Council

National Standard
for
Commercial Vessels

PART C
DESIGN AND CONSTRUCTION

SECTION 4
FIRE SAFETY

Edition 1

First Published — April 2005 (CD)

Draft for public comment issued — 1 June 2004

Endorsed by the Australian Transport Council — November 2004

© Commonwealth of Australia

This work is copyright. Apart from any use as permitted under the *Copyright Act 1968*, no part may be reproduced by any process without written permission of the Chief Executive Officer, NMSC Inc.

Published by The National Marine Safety Committee Inc, Level 11, 207 Kent Street, Sydney NSW 2000. All inquiries to be addressed to the Chief Executive Officer, NMSC Inc.

FOREWORD

This section of the National Standard for Commercial Vessels was prepared as part of the review of the Uniform Shipping Laws Code. It will replace Subsection 5F and Section 11 of the USL Code.

In reviewing the USL Code and preparing this Section, consideration was given to a number of factors including:

- a) Current designs, practices and materials.
- b) Relevant national and international standards.
- c) Provisions no longer used.
- d) Current survey practice, both formal and informal.
- e) Discretionary requirements that rely on authority approval.
- f) Current technical standards format and style.
- g) The Marine Safety Strategy including strategic action 4.4.1 'Adopt standards based on "world's best practice" for *dangerous goods*'.

This standard is based on the fire safety requirements of SOLAS that have been graded appropriate to the levels of risk applicable to vessels in the domestic fleet. For vessels having levels of risk similar to those of vessels in international trade, the full requirements of SOLAS are applied. For simple low risk vessels, a single fire extinguisher may be all that is required. Between these two extremes, the standard specifies compliance progressively by selectively picking up SOLAS requirements and/or modifying SOLAS requirements to provide an appropriate fire safety solution to the particular type of vessel.

This Section of the NSCV shall be read in conjunction with Part B—General Requirements of the NSCV. It should also be read in conjunction with Part A—Safety Obligations of the NSCV.

Prior to commencement of drafting this standard an issues paper was released for public comment in 2001 to assist in identifying deficiencies in the requirements of the USL Code. A reference group comprising representatives of industry and government developed a draft for public comment.

The draft Fire Safety Section and a draft Regulatory Impact Statement were released for public comment on 18 June 2004. The period for public comment closed on 31 August 2004. A reference group comprising industry and government representatives reviewed the public comment on 22 and 23 September 2004 and 13 October 2004, making recommendations for approval by NMSC.

ATC endorsed the document in November 2004, with NMSC approving the final draft on 1 March 2005, and ORR reporting that the final RIS was satisfactory on 15 February 2005.

The standard was first published in April 2005.

CONTENTS

CHAPTER 1	PRELIMINARY	10
	1.1 Scope	10
	1.2 Application	10
	1.3 Objective.....	10
	1.4 Use of the standard	10
	1.5 Definitions.....	13
	1.6 Assumptions and approach	19
	1.7 Fire risk categories of vessels	21
	1.8 Categories of spaces.....	22
	1.9 Referenced documents	24
	1.10 Abbreviations.....	27
CHAPTER 2	FIRE SAFETY OUTCOMES AND SOLUTIONS	29
	2.1 Scope	29
	Required outcomes.....	29
	2.2 Prevention of explosive combustion	29
	2.3 Control of risks of spillage of flammable liquids.....	29
	2.4 Control risks of ignition by sources of heat or sparks	29
	2.5 Prevention of exposure to the smoke and heat of fire	29
	2.6 Prevent or delay the spread of fire	29
	2.7 Protection of essential systems	29
	2.8 Redundancy	30
	Deemed-to-satisfy solutions.....	30
	2.9 Compliance.....	30
	Equivalent solutions	31
	2.10 Assessment methods	31
	2.11 Standards for additional equipment, where fitted	31
CHAPTER 3	GENERAL REQUIREMENTS FOR PASSIVE FIRE PROTECTION MEASURES	32
	3.1 Scope	32
	3.2 Storage of combustible or flammable oils.....	32
	3.3 Engine exhausts, boiler and galley uptakes	32
	3.4 Certain highly flammable materials prohibited.....	32
	3.5 Insulation	33
	3.6 Paints, varnishes & other finishes on passenger vessels.....	33
	3.7 Structural fire protection	34

3.8	Penetrations in fire-resisting divisions	38
3.9	Maintenance of structural integrity.....	42
3.10	Materials for overboard fittings	43
CHAPTER 4	GENERAL REQUIREMENTS FOR ACTIVE FIRE PROTECTION MEASURES	44
4.1	Scope	44
4.2	Remote stops for ventilation and exhaust fans.....	44
4.3	Ventilation closing appliances.....	44
4.4	Centralised fire control functions on passenger vessels	44
4.5	Fire detection and fire alarm system	45
4.6	Emergency escape breathing devices.....	46
4.7	Fire hose appliances	47
4.8	Fire buckets	57
4.9	Fixed fire-extinguishing systems	57
4.10	Portable and wheeled fire extinguishers.....	60
4.11	Fire-fighters' outfits	65
CHAPTER 5	FIRE SAFETY PREPAREDNESS	66
5.1	Application	66
5.2	Objective.....	66
5.3	Fire control plan.....	66
5.4	Training manual.....	67
5.5	Fire safety operational booklet	68
CHAPTER 6	HIGH FIRE RISK SPACES	69
6.1	Scope	69
6.2	Application	69
6.3	General requirements applicable to High Fire Risk Spaces	69
6.4	Machinery spaces of high fire risk	71
6.5	Ro-Ro spaces.....	76
6.6	Cargo spaces containing dangerous goods	81
6.7	Helidecks	84
6.8	Store spaces containing packaged flammable or combustible liquids	86
6.9	Flammable and combustible vessel's stores	88
6.10	Storage of gas cylinders for compressed, liquefied or dissolved gases for the vessel's use	89
CHAPTER 7	MODERATE FIRE RISK SPACES	91
7.1	Scope	91
7.2	Application	91

7.3	General requirements applicable to Moderate Fire Risk Spaces ...	91
7.4	Machinery space of moderate fire risk.....	92
7.5	Galley spaces	94
CHAPTER 8	ACCOMMODATION SPACES	100
8.1	Scope	100
8.2	General requirements applicable to Accommodation Spaces.....	100
8.3	Smoking.....	100
8.4	Heating appliances	101
8.5	Waste receptacles	101
8.6	Additional restrictions on the use of combustible materials.....	102
8.7	Oil piping in Accommodation spaces.....	103
8.8	Grouping of means for controlling power ventilation	103
8.9	Smoke zones.....	103
8.10	Draught stops	105
8.11	Smoke extraction systems in atriums of passenger vessels	105
8.12	Blind corridors.....	105
8.13	Alternative safe areas	105
8.14	Internal stairways.....	106
8.15	Smoke detectors in Accommodation Spaces	108
8.16	Manually operated call points	109
8.17	Inspection Hatches	109
8.18	Fire hose appliances	109
8.19	Portable fire extinguishers	110
8.20	Aqueous fixed fire-extinguishing systems	110
CHAPTER 9	MINOR FIRE RISK SPACES	112
9.1	Scope	112
9.2	Application	112
9.3	General requirements applicable to Minor Fire Risk Spaces.....	112
9.4	Cargo spaces	112
CHAPTER 10	CONTROL STATIONS	116
10.1	Scope	116
10.2	Application	116
10.3	General Requirements applicable to Control Stations	116
10.4	Exposed surfaces	116
10.5	Concealed or inaccessible spaces	117
10.6	Ventilation of Control Stations	117
10.7	Smoke detectors in Control Stations	117
10.8	Manually operated call points	117

	10.9	Portable fire extinguishers	118
CHAPTER 11		ESCAPE OR EVACUATION ROUTES	119
	11.1	Scope	119
	11.2	Application	119
	11.3	General requirements applicable to Escape or Evacuation Routes	119
	11.4	Exposed surfaces in corridors and stairway enclosures.....	120
	11.5	Furniture in stairway enclosures.....	120
	11.6	Stair towers.....	120
	11.7	External open stairways	121
	11.8	Protection of survival craft	121
	11.9	Fixed fire detection and fire alarm system.....	121
CHAPTER 12		FIRE PROTECTION MEASURES—DESIGN, CONSTRUCTION AND INSTALLATION	122
	12.1	Scope	122
	12.2	Objective.....	122
		Required outcomes	122
	12.3	Type.....	122
	12.4	Performance	122
	12.5	Safety of personnel.....	122
	12.6	Availability.....	122
	12.7	Reliability	122
	12.8	Operating instructions.....	123
		Deemed-to-satisfy solutions	123
	12.9	Compliance.....	123
	12.10	Standards for fire safety materials and equipment	123
	12.11	Installation and testing.....	123
CHAPTER 13		SERVICING OF FIRE EQUIPMENT	128
	13.1	Scope	128
	13.2	Objective.....	128
		Required outcomes	128
	13.3	Maintenance of function	128
	13.4	Reliability	128
	13.5	Quality	128
		Deemed-to-satisfy solutions	128
	13.6	Compliance.....	128
	13.7	Servicing scope and frequency	128
	13.8	Competence	129

ANNEX A	FIRE HAZARD ANALYSIS	130
A1	Scope	130
ANNEX B	EQUIVALENT SOLUTIONS FOR FIRE SAFETY SYSTEMS	137
B1	Objective.....	137
B2	General.....	137
B3	Assessment methods	137
B4	Documentation	138
B5	Re-evaluation due to change of conditions	138
ANNEX C	TESTING OF FIRE HOSE APPLIANCES	139
C1	Scope	139
C2	Application.....	139
C3	Required outcome	139
C4	Testing procedure.....	139
C5	Acceptance criteria	139
ANNEX D	NON-COMBUSTIBLE MATERIALS	140
D1	Scope	140
D2	Application.....	140
D3	Required outcome	140
D4	Testing procedure.....	140
D5	Acceptance criteria	140
ANNEX E	LOW FLAME SPREAD SURFACES	141
E1	Scope	141
E2	Application.....	141
E3	Required outcome	141
E4	Testing procedure.....	141
E5	Acceptance criteria	141
ANNEX F	CRITERIA FOR GROUP 1, GROUP 2 AND GROUP 3 EXPOSED BULKHEAD AND CEILING MATERIALS AND LININGS	142
F1	Scope	142
F2	Application.....	142
F3	Required outcome	142
F4	Definitions.....	142
F5	Testing procedures.....	142
F6	Acceptance criteria	143
F7	Transitional arrangements.....	143
ANNEX G	CRITERIA FOR LEVEL 1, LEVEL 2 AND LEVEL 3 EXPOSED FLOOR MATERIALS AND COVERINGS.....	144
G1	Scope	144

	G2	Application	144
	G3	Required outcome	144
	G4	Definitions	144
	G5	Testing procedure.....	144
	G6	Acceptance criteria	144
	G7	Transitional arrangements.....	145
ANNEX H		CRITERIA FOR FURNITURE THAT COMPLIES WITH THE REQUIREMENTS FOR FIRE-RESTRICTING MATERIALS	146
	H1	Scope	146
	H2	Application	146
	H3	Required outcome	146
	H4	Acceptance criteria	146
ANNEX I		CRITERIA FOR COMBUSTIBLE SOUND AND THERMAL INSULATION	147
	I1	Scope	147
	I2	Application	147
	I3	Required outcome	147
	I4	Testing procedures	147
	I5	Acceptance criteria	147
ANNEX J		PERFORMANCE OF FOAM MAKING BRANCH PIPES	148
	J1	Scope	148
	J2	Application	148
	J3	Description.....	148
	J4	Performance	148
	J5	Spare concentrate	148
ANNEX K		TRANSITIONAL ARRANGEMENTS FOR FIRE-RESTRICTING MATERIALS	149
	K1	Scope	149
	K2	Application	149
	K3	Testing procedure.....	149
	K4	Acceptance criteria	149

CHAPTER 1 PRELIMINARY

1.1 SCOPE

This Section of the NSCV specifies requirements for the design, construction and installation of *passive* and *active fire protection measures* in vessels and the maintenance of *fire equipment*.

It shall be read in conjunction with the following provisions of the NSCV: Part B—General Requirements, Part C Section 5: Engineering and Part E—Operational Practices.

1.2 APPLICATION

This Section applies to all vessels other than Special Vessels provided for in Part F of this standard, unless Part F specifies otherwise. See also Clause 2.9.

NOTES:

1. Gas carriers and chemical tankers are considered novel vessels under Part F Section 3.
2. Fast craft and hire and drive vessels are included in Special Vessels under Part F Section 1 and Part F Section 2 respectively.

1.3 OBJECTIVE

The objective of this Section is to control to acceptable levels or, where practicable, eliminate the risks to persons arising from—

- a) fire; and
- b) the fire control measures themselves.

NOTES:

1. Fire hazards on a vessel include: the collection of flammable vapours within enclosed spaces; rupture of high pressure fuel or hydraulic oil lines; spillage or escape of fuel oil or lubricating oil; normal sources of heat such as cooking and heating appliances; incinerators; engine turbochargers; exhaust piping and trunking; abnormal sources of heat such as short-circuiting or overloading of electrical systems; overheating of mechanical components; cigarette smoking; arson.
2. Consequences of fire may include: reduced visibility and disorientation caused by the presence of smoke; hindrance to safe egress; suffocation; toxic poisoning; excessive heat causing untenable conditions for humans; the spread of fire; structural failure; damage to essential systems including lifesaving equipment; loss of watertight integrity.
3. Examples of risks associated with fire control measures include: asphyxiation or poisoning caused by fire extinguishing agents; environmental damage caused by extinguishing agents; and electrocution associated with improper choice of portable fire extinguishing agents.

1.4 USE OF THE STANDARD

Flowcharts are provided to assist users applying the standard. Figure 1 illustrates the process for determining the application of this section and the source of the applicable deemed-to-satisfy solutions for a particular vessel.

Figure 2 shows the method of how the standard is used to provide deemed-to-satisfy solutions.

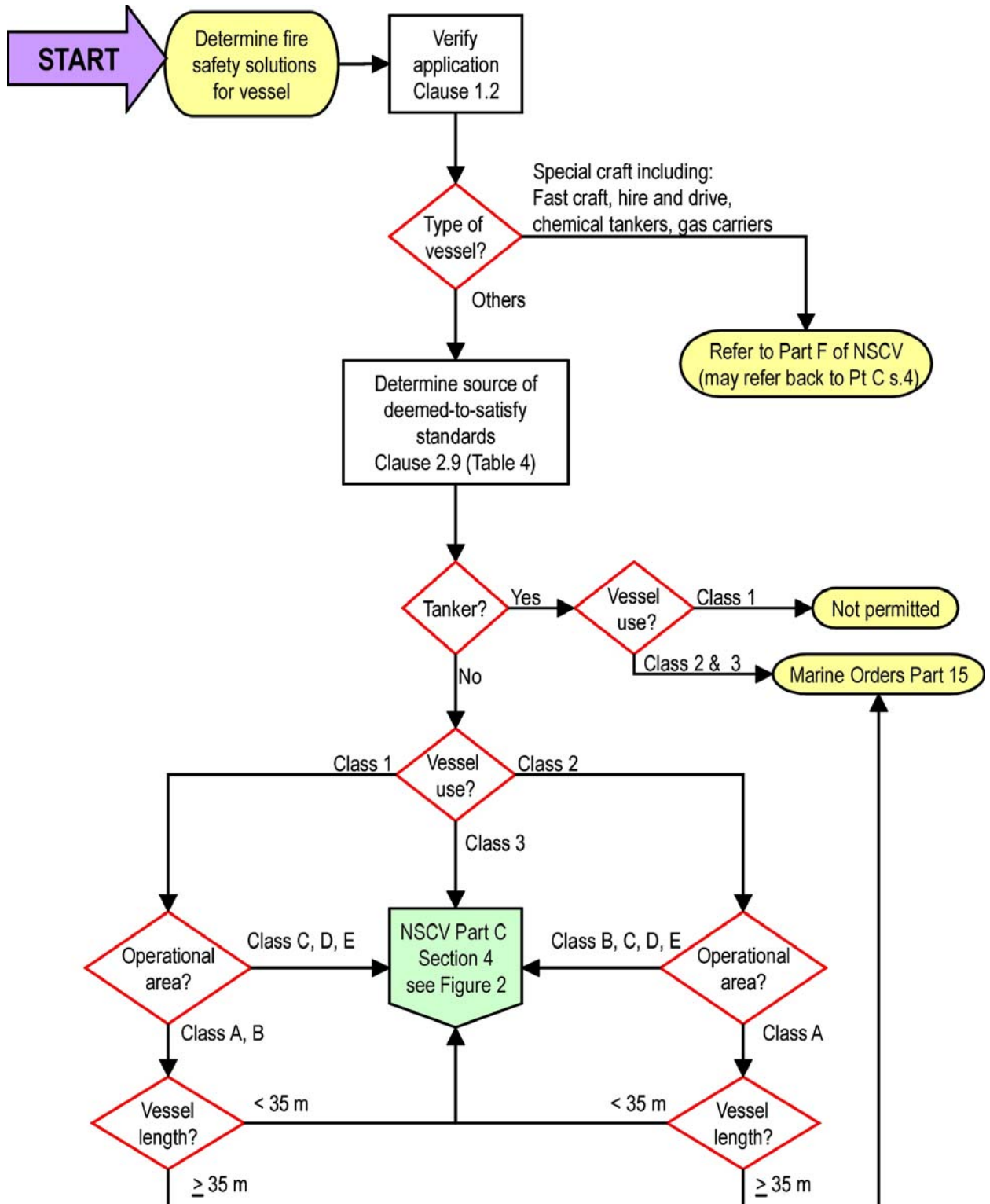

Figure 1 — Flowchart for determining the application of this Section and the source of applicable deemed-to-satisfy solutions

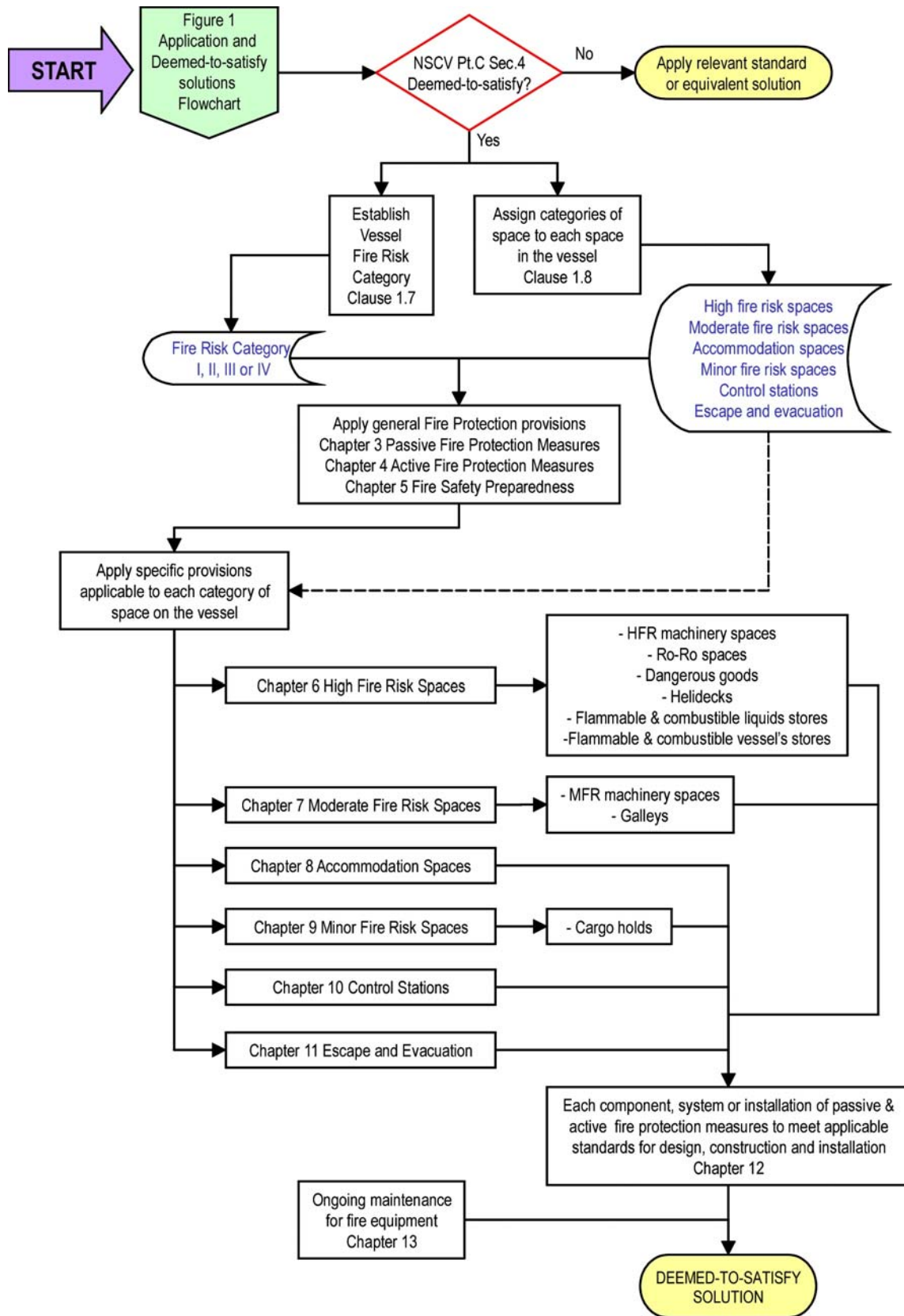

Figure 2 — Flowchart for determining the deemed-to-satisfy requirements contained in this Section

1.5 DEFINITIONS

For the purposes of this Section of the National Standard for Commercial Vessels—

- a) the definitions provided in Part B of the NSCV, in addition to those in this Clause, shall apply; and
- b) where there is any duplication in the terms defined between this Clause and Part B, the definition in this Clause shall apply.

Throughout this Section, terms defined in this Clause are indicated by italic text.

accommodation space—

a category of space defined in Table 3.

active fire protection measures—

those elements of the design, construction and *fire equipment* of the vessel and emergency procedures that eliminate or control the risk of fire by active means i.e. they must be activated at the time of fire to be effective.

EXAMPLES:

Fire detection and fire alarm systems,

fixed fire-extinguishing systems,

fire appliances,

fuel shut-offs and ventilation and electrical shutdowns.

atrium—

a public space spanning three or more decks having openings or access ways between decks that cannot be sealed thus allowing smoke to move freely from one deck to the others.

central control station—

a *Control Station* in which essential indicator and control functions are centralised.

NOTE: Refer to Clause 4.4.

closed Ro-Ro spaces—

Ro-Ro spaces that are neither *open Ro-Ro spaces* nor *weather decks*.

NOTES:

1. Refer also to the definitions of *Ro-Ro spaces*, *open Ro-Ro spaces* and *weather decks*.
2. A *special category space* is a type of *closed Ro-Ro space*.

closed vehicle spaces—

cargo spaces intended for the carriage of motor vehicles with fuel in their tanks for their own propulsion that—

- a) are not *Ro-Ro spaces*; and
- b) are not provided with adequate natural ventilation effective over their entire length through permanent openings distributed in the side plating or deckhead, or from above.

NOTES:

1. A *closed vehicle space* contains vehicles loaded by means other than being driven on board the vessel.

2. A vehicle space that would meet the ventilation characteristics specified for an *open Ro-Ro space* or a *Ro-Ro weather deck* is not a *closed vehicle space* for the purposes of this definition.

combustible liquid—

any liquid, other than a *flammable liquid*, that has—

- a) a flashpoint; and
- b) a firepoint less than its boiling point.

combustible material—

any material other than a *non-combustible* material.

control station—

a category of space defined in Table 3.

dangerous goods—

those packaged dangerous goods that fall within the application of Clause 4 of the National Standard for the Storage and Handling of Dangerous Goods (NOHSC:1015).

NOTES:

1. For the application of this standard, the definition of dangerous goods excludes fuels and oils used for the propulsion of the vessel.
2. Dangerous goods carried in bulk are subject to standards applicable to *tankers* (see definition below) or are subject to the International Bulk Chemical Code.

defence-in-depth—

a strategy for fire protection where multiple fire protection measures are employed at various stages in the development of a fire to reduce the likelihood of rapid transition from a potential ignition state to a fully developed catastrophic state, see Clause 1.6.2.

escape or evacuation route—

a category of space defined in Table 3.

fire appliance—

an item of *fire equipment* that requires an operator to deploy and control the item when manually fighting a fire.

EXAMPLES:

portable and wheeled fire extinguishers;
fire hoses;
fire buckets;
water fog applicators;
foam making branch pipes.

fire damper—

a device arranged to close a ventilation opening or ventilation duct for the purposes of maintaining the performance of the fire boundary through which the opening or duct passes.

NOTE: Fire dampers may be designed to also serve as *fire flaps*.

fire detection and fire alarm system—

those elements of the construction and equipment of the vessel, and any operational procedures, that detect the presence of fire or potential risk of fire and subsequently raise an alarm.

EXAMPLES:

fixed fire detection and fire alarm systems

smoke alarms

fire patrols

fire equipment—

consists of *fire detection and alarm systems, fire appliances, fixed fire-extinguishing systems* and fire personal protective equipment.

fire flap—

a device arranged to close off a ventilation opening or ventilation duct for the purposes of sealing a compartment to exclude oxygen and/or confine and contain extinguishing media.

NOTE: Fire flaps may be designed to also serve as *fire dampers*.

fire-resisting division—

a division formed by bulkheads and/or decks having insulation or inherent fire-resisting properties

NOTE: Chapter 12 specifies the performance requirements for fire resisting divisions.

fire-restricting material—

a material having properties that retard and/or reduce the hazardous effects of fire.

NOTE: Chapter 12 specifies the performance requirements for fire-restricting materials.

Fire Risk Category of vessel—

a measure of the risk of fire determined by the category of vessel, number of passengers on board and number of berthed passengers on board, refer to Clause 1.7.

fixed fire detection and fire alarm system—

an integrated system of detectors, manual call points and alarms that are monitored and controlled through one or more central control panels.

fixed fire-extinguishing system—

an arrangement of components forming a single system that when manually or automatically initiated, operates automatically to control, suppress or extinguish a fire without the need for further manual control.

EXAMPLES:

Total flooding systems;

Local fire-extinguishing systems.

flammable liquid—

any liquid that has a flashpoint of 60°C or less, except:

- a) Liquids having a flashpoint not less than 23°C nor greater than 60°C, but which have a firepoint greater than 104°C or which boil before the fire point is reached.

NOTE: This criterion exempts many flammable liquids, water mixtures and blends of petroleum products for which the flash point does not truly represent the flammability hazard.

- b) Aqueous solutions containing not more than 24 per cent ethanol by volume.

- c) Alcoholic beverages and other products for human consumption, in containers of not more than 5 L capacity.
- d) Substances otherwise classified as *dangerous goods* on account of their other more dangerous characteristics.

flammable and combustible vessel's stores—

includes paints, *flammable liquids* and other stores of *flammable* and/or *combustible liquids* that are used in the operation and maintenance of the vessel.

NOTE: Flammable or combustible vessel's stores include fuel stored for use in the outboard engines of tenders carried on the vessel.

foam making branch pipe—

a *fire appliance* that, when connected to the fire main water supply and inserted into a drum of foam concentrate, generates quantities of foam water mixture.

NOTE: This device is referred to as a portable foam applicator unit in SOLAS and Marine Orders 15.

galley—

an enclosed space containing—

- a) equipment used for cooking food at temperatures exceeding 120°C including cooking equipment for deep fat frying;
- b) equipment having an exposed flame or cooking element that might come into contact with and ignite fats or other *flammable liquids* during the course of normal or abnormal operation; or
- c) any appliance of power more than 5 kW used for the cooking or heating of food.

NOTE: Refer also to the definitions of *large galley* and *small galley*.

helideck—

a purpose-built helicopter landing area located on a vessel. It includes all structures, fire-fighting appliances and other equipment necessary for the safe operation of helicopters.

high fire risk space—

a category of space defined in Table 3.

hob—

that part of a cooking appliance that supports the *trivet*. Usually constructed of enamelled steel, stainless steel or toughened glass.

large galley—

a *galley* that is not a *small galley*.

limited quantities of dangerous goods—

small quantities of packaged *dangerous goods* specified in the current IMDG Code or the current IDG Code for which the Dangerous Goods Code provisions do not apply.

NOTE: Limited quantities of *dangerous goods* amount to quite small quantities, for example, 1 litre of petrol.

low risk cargo space—

cargo spaces on Class 2 or Class 3 vessels constructed and solely intended for the carriage of ore, grain, unseasoned timber, fish, *non-combustible* cargoes or cargoes that constitute a low fire risk.

low flame spread—

a surface having properties that restrict the spread of flame.

NOTE: Chapter 12 specifies the performance requirements for low flame spread surfaces.

minor fire risk space—

a category of space defined in Table 3.

minor quantity of dangerous goods—

packaged *dangerous goods* of quantity less than the placarding quantity specified under Schedule 1 of the National Standard for the Storage and Handling of Workplace Dangerous Goods (NOHSC:1015).

EXAMPLES:

For paints and kerosene, the placarding quantity is 1000 L.

For petrol and aviation fuel, the placarding quantity is 250 L.

moderate fire risk space—

a category of space defined in Table 3.

non-combustible material—

a material that neither burns nor gives off flammable vapours in sufficient quantity for self-ignition when heated to approximately 750°C.

NOTE: Chapter 12 specifies the performance requirements for non-combustible materials.

oil fuel unit—

the equipment used for the preparation of oil fuel for delivery to an oil-fired boiler, or equipment used for the preparation of heated oil for delivery to an internal combustion engine. Includes any oil pressure pumps, filters, heaters and piping dealing with oil at a pressure of more than 180 kPa.

NOTE: The definition does not apply to equipment used for the preparation or delivery of diesel fuel that is not heated for use in an internal combustion engine.

open Ro-Ro spaces—

Ro-Ro spaces arranged to allow effective natural ventilation while underway, not being *weather decks*.

NOTE: Refer to Clause 6.5.2.2.

operating compartment—

the enclosed area from which the navigation and control of the vessel is exercised.

pantry—

a space, not being a *galley*, used for the preparation or distribution of food and beverages.

NOTE: Refer to the definition of *galley* above.

EXAMPLES:

Spaces containing:

1. Microwave ovens for heating of food;
2. Bain-marie appliances, each of 5 kW or less, for keeping food warm; or
3. Appliances, each of 5 kW or less, used solely for boiling water or water-based beverages.

passive fire protection measures—

features of the design and construction of the vessel and fire-safe operational procedures that eliminate or control the risks of fire by passive means: i.e., they do not require activation at the time of fire to be effective.

EXAMPLES:

- Fuel system design and installation requirements;
- electrical installation requirements;
- fire-resisting divisions*;
- the use of *non-combustible* or *fire-restricting materials*;
- escape and evacuation requirements that limit the consequences of fire.

public spaces—

those portions of the *Accommodation Space* that are public halls, dining rooms, lounges and similar enclosed spaces where persons are able to congregate.

Ro-Ro spaces—

spaces intended primarily for carrying motor vehicles with fuel in their tanks for their own propulsion that are loaded and unloaded in a horizontal direction. Ro-Ro spaces extend either a substantial length or the entire length of the vessel, are not normally subdivided and may also contain goods that are loaded and unloaded by motor vehicles.

NOTES:

1. *Ro-Ro spaces* are classified as *open Ro-Ro spaces*, *closed Ro-Ro spaces* or *weather decks*.
2. Goods in *Ro-Ro spaces* may be packaged or in bulk, in or on rail or road cars, vehicles (including road or rail tankers), trailers, containers, pallets, demountable tanks or in or on similar stowage units or other receptacles.

small galley—

a *galley* containing a single compact domestic range (no more than 4 burners or hotplates, and oven) of total gas consumption less than 65 mJ/hr or total electricity consumption less than 9 kW.

small machinery space—

a machinery space of *Moderate Fire Risk* that—

- a) is not capable of being occupied;
- b) has a volume of 10 m³ or less; and
- c) for which access to the space to extinguish a fire would prove hazardous.

smoke alarm—

a device that independently detects the presence of smoke, sounds an alarm and tests function status from the location of installation.

smoke-tight—

a division made of *non-combustible* or *fire-restricting materials* capable of preventing the passage of smoke.

special category space—

a *closed Ro-Ro space* to which passengers may have access.

tanker—

a Class 2 or Class 3 vessel carrying—

- a) crude oil or petroleum products in bulk with—
 - i) a flashpoint of 60°C or less (closed cup test), as determined by an approved flashpoint apparatus; and
 - ii) a Reid vapour pressure which is below the atmospheric pressure; or
- b) other liquid products having a similar fire hazard.

NOTES:

1. Liquid cargoes with a flashpoint exceeding 60°C, other than oil products or liquid cargoes subject to the requirements of the International Bulk Chemical Code, are considered to constitute a low fire risk.
2. As a deemed-to-satisfy solution, *tankers* are prohibited from operating as Class 1 vessels, see Clause 2.9.

time rating—

the minimum time period needed to ensure that a bulkhead; deckhead; closing appliance; penetration; or other fixture meets the requirements for a *fire-resisting division*.

trivet—

a grid located over the open burners of a cooking range to support vessels being heated.

water fog applicator—

a metal L-shaped pipe, the long limb being about 2 m in length capable of being fitted to a fire hose and the short limb being about 250 mm in length fitted with a fixed water fog nozzle or capable of being fitted with a water spray nozzle.

weather deck—

a deck that is completely exposed to the weather from above and from at least two boundaries to the space.

1.6 ASSUMPTIONS AND APPROACH

1.6.1 Risk-based approach to solutions

SOLAS Chapter II-2 has been used as the basis for the requirements contained in this Section. However, Chapter II-2 of SOLAS is intended for vessels that operate independently on international voyages. SOLAS does not apply to vessels that operate in sheltered waters, or to cargo vessels less than 500 GT, nor does it apply to fishing vessels. SOLAS provides for modification of requirements for vessels that do not proceed more than 20 nautical miles from the nearest land.

The risks associated with those vessels for which SOLAS does not apply may differ significantly from those applicable to vessels under SOLAS. Hence, to apply SOLAS without modification to all vessels would be inappropriate.

Clause 2.9 of this section applies SOLAS to tankers and certain larger seagoing vessels in the domestic fleet by specifying Marine Orders 15 as the deemed-to-satisfy solution. For other vessels, Clause 2.9 specifies compliance with the deemed-to-satisfy solutions contained within this section.

These employ a risk-based approach to match appropriate risk control solutions to the needs of individual vessels.

The risk-based approach has two levels. The first applies to the vessel as a whole; the second applies to individual spaces within a vessel.

The fire risk level applicable to a vessel is assumed to be a function of key risk parameters that are major determinants in the likelihood and consequence of a fire on a vessel. Risk matrices are applied which determine fire safety solutions based on the *Fire Risk Category*, see Clause 1.7.

The fire risk associated with a space is assumed to be a function of the use of the space in normal and emergency conditions and the contents of the space. The nature of the space is significant both in terms of the likelihood of fire and the consequences of fire, see Clause 1.8.

NOTE: AS/NZS 4360 and Part B of the NSCV provide further information on the application of risk management techniques.

1.6.2 Fire safety measures provide defence-in-depth

This Section prescribes a combination of fire safety measures which, taken as a whole, provides the minimum required standard for controlling the risks associated with fire. A *defence-in-depth* strategy is adopted, broadly based on a series of measures applicable to different states of a fire as it progresses from ignition to fully developed state. These are illustrated in Table 1¹.

Table 1 — Stages of *defence-in-depth* strategy

Fire state	Fire protection features	Examples of solutions
Ignition and incipient fire	Control of heat sources, fuels, interactions	Insulation, tank and fuel system design, dangerous goods stowage
	Very early detection	Fire patrols, gas detectors, oil pressure monitoring
First item development	Material properties	Non-combustible materials, fire-restricting materials, low flame spread surfaces
	Fire detection	Heat and smoke detectors, fire patrols
Spread to secondary items	Fire detection	Heat and smoke detectors, fire patrols
	Fire suppression	Portable extinguishers, fire blankets
Full space involvement	Fire suppression	Fixed fire-extinguishing systems, fire hose appliances
	Ventilation control	Fire flaps and fan shutdowns
Spread to other spaces	Fire resistance	Separation of spaces, fire-resisting divisions, ventilation design
	Manual suppression	
Spread to essential systems	Fire resistance	Separation of spaces, <i>fire-resisting divisions</i>
	Manual suppression	Fire hoses
	Redundancy	Duplication of generators, fire pumps, etc

¹ Adapted from Mowrer, Frederick W., Brannigan, Vince. A Probabilistic Approach to Tenability Criteria. Proceedings of the 4th International Conference on Performance-Based Codes and Fire Safety Design Methods. Melbourne. 2002.

1.6.3 Early detection and extinction

Notwithstanding the presence of *defence-in-depth*, priority is given to measures that provide for the avoidance of fire, early detection of conditions that could give rise to fire, early detection of the occurrence of fire and the early extinction of fire.

1.6.4 Key hazards

Annex A summarises the key fire hazards addressed by the provisions of this Section and other sections of the NSCV. The table forms the basis for the requirements contained in this Section.

1.6.5 Functional requirements of deemed-to-satisfy solutions

The following functional requirements are embodied in the deemed-to-satisfy solutions of this Section as appropriate:

- a) Avoidance of fire hazards.
- b) Restricted use of *combustible materials*.
- c) Minimal possibility of ignition of *flammable liquids* or vapour.
- d) Early detection of any fire in the zone of origin.
- e) Containment and extinction of any fire in the space of origin.
- f) Separation of spaces of varying fire risk by smoke, thermal and structural boundaries.
- g) Protection of means of escape, evacuation and access for fire-fighting.
- h) Ready availability of *fire appliances*.

1.7 FIRE RISK CATEGORIES OF VESSELS

The Fire Risk Category of a vessel shall be determined from Table 2.

Four fire risk categories are defined as follows:

- a) Fire Risk Category I (lowest risk).
- b) Fire Risk Category II (moderate risk).
- c) Fire Risk Category III (high risk).
- d) Fire Risk Category IV (highest risk).

Table 2 — Fire Risk Category

Vessel use category (see Part B)	Operational area category (see Part B)				
	Class A Unlimited domestic operations	Class B Offshore operations	Class C Restricted offshore operations	Class D Partially smooth waters	Class E Smooth waters
Class 1— Length of vessel	< 35 m (1)	<35 m (1)	All lengths	All lengths	All lengths
Class 1: 13 to 36 day passengers	III	II	II	I	I
Class 1: 37 to 200 day passengers	IV	III	II	II	II
Class 1: 201 to 450 day passengers	IV	IV	III	II	II
Class 1: 451 or more day passengers	Not applicable (2)	Not applicable (2)	IV	IV	III
Class 1: 13 to 36 berthed passengers	IV	III	II	II	II
Class 1: 37 or more berthed passengers	Not applicable (2)	Not applicable (2)	IV	IV	IV
Class 2— Length of vessel	< 35 m (1)	All lengths	All lengths	All lengths	All lengths
Class 2 Fire Risk Category	II	II	I	I	I
Class 3— Length of vessel	All lengths	All lengths	All lengths	All lengths	All lengths
Class 3 Fire risk category	II	II	I	I	I

KEY:

- (1) No Fire Risk Category is specified for Class 1A, 2A and 1B vessels 35 m and more in measured length since these vessels are required to comply with Marine Orders 15, refer to Clause 2.9.
- (2) No Fire Risk Category is specified for Class 1A and 1B vessels carrying more than 450 day passengers or more than 36 berthed passengers since these vessels are required to comply with Marine Orders 15, refer to Clause 2.9.

NOTE: Excludes *tankers* and special vessels including fast craft and novel vessels, see Clauses 1.2 & 2.9.

1.8 CATEGORIES OF SPACES

1.8.1 Determination

Spaces shall be assigned a space category in accordance with Table 3. Where there is doubt as to the category of a space, the space shall satisfy the most stringent fire safety requirement.

1.8.2 Spaces of multiple classification

Where it is possible to assign two or more classifications to a space, it shall be provided with *active* and *passive fire protection measures* that satisfy the more stringent of the requirements specified for each applicable classification.

Table 3 — Categories of spaces

Space category	Description	Examples
High Fire Risk Spaces	<p>Spaces where, without appropriate controls, the likelihood and consequence of fire are high.</p> <p>Within such spaces, there is:</p> <ul style="list-style-type: none"> potential for the spillage or escape of potentially dangerous quantities of <i>flammable liquid</i> or explosive vapour, and the presence of one or more sources of heat or other sources of ignition. 	<p>a) Enclosed machinery spaces containing—</p> <ul style="list-style-type: none"> internal combustion machinery for main propulsion where the aggregate power output of internal combustion machinery for all purposes within the space is 120 kW or more; internal combustion machinery for purposes other than propulsion where the aggregate total power output of the machinery within the space is: <ul style="list-style-type: none"> 375 kW or more; or 120 kW or more where the machinery is not intended only for emergency or very occasional use²; any oil-fired boiler; or any <i>oil fuel unit</i>. <p>b) <i>Ro-Ro spaces</i>.</p> <p>c) Store spaces containing <i>flammable liquids</i>, including paint lockers.</p> <p>d) Spaces containing <i>dangerous goods</i>.</p> <p>e) Sales shops of deck area 50 m² or more containing packaged <i>flammable liquids</i> for sale and where no dedicated store is provided separately.</p> <p>f) Trunks in direct communication with the above spaces.</p>
Moderate Fire Risk Spaces	<p>Spaces that:</p> <ul style="list-style-type: none"> contain potentially dangerous quantities of <i>flammable liquids</i> but where the sources of ignition have relatively low frequency; or contain heat sources or other sources of ignition but where the quantity or nature of material within the space to fuel a fire is such that the risk is significantly reduced. 	<p>a) Enclosed machinery spaces containing:</p> <ul style="list-style-type: none"> Internal combustion machinery where the aggregate power output of internal combustion machinery for all purposes within the space is less than 120 kW; Internal combustion machinery for purposes other than propulsion where the aggregate total power output of the machinery within the space is less than: <ul style="list-style-type: none"> 375 kW where the machinery is intended only for emergency or very occasional use²; or 120 kW otherwise. switchboards, electrically powered main propulsion or auxiliary motors or transformers when such equipment within the space has a total aggregate power of 30 kVA or more. an oil fuel pump, oil fuel filter or oil fuel separator, not being an <i>oil fuel unit</i>. any solid fuel fired boiler. <p>b) <i>Galleys</i>.</p> <p>c) Sales shops of deck area less than 50 m² containing packaged <i>flammable liquids</i> for sale and where no dedicated store is provided separately.</p>

(Continued...)

² Very occasional use is taken to mean less than 1 per cent of total vessel operating time.

Table 3 cont.

Space category	Description	Examples
Accommodation Space	Spaces that are likely to contain persons who: <ul style="list-style-type: none"> are unfamiliar with the vessel, may be asleep or disoriented at the time of an emergency, or may inadvertently or deliberately initiate a fire. 	<ul style="list-style-type: none"> a) Sleeping rooms. b) Mess rooms. c) <i>Pantries</i>. d) <i>Public spaces</i>. e) Toilets and washrooms. f) Sales shops not containing <i>flammable liquids</i> for sale. g) Storerooms of floor area less than 4 m² incorporated within or adjacent to other types of <i>Accommodation Spaces</i> and which are not used for the storage of <i>combustible</i> or <i>flammable liquids</i> or <i>dangerous goods</i>.
Minor Fire Risk Spaces	Spaces where the likelihood and/or consequence of fire is low.	<ul style="list-style-type: none"> a) Spaces used for the carriage of cargo that is not <i>dangerous goods</i>. b) <i>Closed vehicle spaces</i>. c) Void spaces. d) Fuel tanks and spaces containing fuel tanks for fuel of flashpoint above 60°C. e) Storerooms including baggage or mail rooms not used for the storage of <i>combustible</i> or <i>flammable liquids</i> or <i>dangerous goods</i>.
Control Stations	Spaces containing systems essential to the safety of persons, which, if destroyed or rendered unusable by fire, would substantially increase the risks to those on board.	<ul style="list-style-type: none"> a) <i>Operating compartment</i>. b) Radio room. c) Central fire <i>Control Station</i>. d) Damage <i>Control Station</i>. e) The emergency source of electrical power or the emergency switchboard. f) Fixed fire extinguishing <i>Control Station</i>, agent storage or machinery room.
Escape or Evacuation Routes	Spaces essential for escape from spaces on board the vessel and for evacuation from the vessel, which if destroyed or rendered unusable by fire, would substantially increase the risks to those on board.	<ul style="list-style-type: none"> a) Corridors of length 14 m and over in <i>Accommodation Spaces</i> and corridors for escape and evacuation elsewhere. b) Enclosed stairways and stairway towers. c) Assembly stations. d) Survival craft stowage locations. e) Ship's side in way of survival craft stowage or embarkation point.

NOTE: The title of each category is intended to be typical rather than restrictive.

1.9 REFERENCED DOCUMENTS

The following documents are referred to in this Section of the NSCV. Any documents referenced in this Section shall be considered the latest revision of the document, including amendments and supplements.

NATIONAL MARINE SAFETY COMMITTEE

National Standard for Commercial Vessels

Part B—General Requirements

Part C—Design and Construction

Section 1: Arrangement, Accommodation and Personal Safety

Section 2: Watertight and Weathertight Integrity

Section 5: Engineering

Subsection 5A—Machinery

Subsection 5B—Electrical

Section 7: Safety Equipment

Part E—Operational Practices

STANDARDS AUSTRALIA

AS/NZS 1221—*Fire hose reels*

AS 1530—*Part 1 – Methods for fire tests on building materials, component and structures – combustibility tests for materials*

AS/NZS 1530—*Part 3 – Methods for fire tests on building materials, component and structures – simultaneous determination of ignitability, flame propagation, heat release and smoke release*

AS 1603—*Automatic fire detection and alarm systems*

AS 1670—*Fire detection, warning, control and intercom systems—Systems design, installation and commissioning*

AS/NZS 1715—*Selection, use and maintenance of respiratory protective devices*

AS/NZS 1716—*Respiratory protective devices*

AS/NZS 1841—*Portable fire extinguishers*

AS/NZS 1850—*Portable fire extinguishers – Classification, rating and performance testing*

AS 1851—*Maintenance of fire protection equipment*

AS 2118—*Automatic fire sprinkler systems*

AS 2419—*Fire hydrant installations*

AS 2444—*Portable fire extinguishers and fire blankets – Selection and location*

AS 2792—*Fire hose – Delivery layflat*

AS 3504—*Fire blankets*

AS 3786—*Smoke alarms*

AS/NZS 3837—*Method of test for heat and smoke release rates for materials and products using an oxygen consumption calorimeter*

AS 4214—*Gaseous fire extinguishing systems*

AS 4265—*Wheeled fire extinguishers*

AS/NZS 4360—*Risk management*

AS 5062—*Fire protection of mobile and transportable equipment*

AS 5601—*Gas Installations*

HB13—*Electrical equipment for hazardous areas*

AUSTRALIAN BUILDING CODES BOARD

Building Code of Australia

AUSTRALIAN MARITIME SAFETY AUTHORITY

Marine Orders Part 15—Ship Fire Protection, Fire Detection and Fire Extinction

EUROPEAN UNION

EU Marine Equipment Directive—Council Directive 96/98/Ec (As Amended)

BRITISH STANDARDS INSTITUTION

BS EN 1869—*Fire blankets*

BS 7176—*Specification for resistance to ignition of upholstered furniture for non-domestic seating by testing composites*

BS 7177—*Specification for resistance to ignition of mattresses, divans and bed bases*

INTERNATIONAL CIVIL AVIATION ORGANIZATION

Airport Services Manual, part 1 – Rescue and Fire fighting

INTERNATIONAL MARITIME ORGANIZATION

International Code of Safety for High Speed Craft 2000 (HSC Code)

Code of Alarms and Indicators adopted by the Organization by resolution A.830(19)

International Code for Fire Safety Systems (Fire Safety Systems Code) as adopted by resolution MSC.98(73)

International Code for Application of Fire Test Procedures (Fire Test Procedures Code) as adopted by resolution MSC.61(67)

IMO Resolution A.654 (16) Graphical symbols for fire control plans

MSC Resolution MSC.44(65) Standards for fixed sprinkler systems for high speed craft

MSC Circ.451 Guidance concerning the location of fire control plans for assistance of shoreside fire-fighting personnel

MSC Circ.849 Guidelines for the performance, location, use and care of emergency escape breathing devices

MSC Circ.1007 Guidelines for the approval of fixed aerosol fire-extinguishing systems equivalent to fixed gas fire-extinguishing systems, as referred to in SOLAS 74, for machinery spaces

SOLAS—*The International Convention for the Safety of Life at Sea*

IMO International Maritime Dangerous Goods Code

INTERNATIONAL STANDARDS ORGANIZATION

ISO 1716—*Building material reaction-to-fire tests – Determination of calorific potential*

ISO 4589-3—*Plastics - Determination of burning behaviour by oxygen index - Part 3: Elevated-temperature test*

ISO 5660—*Building material reaction-to-fire tests – Heat release, smoke production and mass loss rate*

ISO 9094-1—*Small Craft - Fire Protection*

ISO 9239—*Reaction to fire tests for floor coverings: Part 1— Determination of the burning behaviour using a radiant heat source*

ISO 9705 Fire tests—*Full scale room test for surface products (Room Corner Test)*

ISO 15371—*Ships and Marine technology – Fire-extinguishing systems for protection of galley deep-fat cooking equipment – fire tests*

ISO 17631:2002—*CE Ships and marine technology CE Shipboard plans for fire protection, life-saving appliances and means of escape*

NATIONAL FIRE PROTECTION ASSOCIATION

NFPA 15—*Water Spray Fixed Systems for Fire Protection*

NFPA 17—*Standard for Dry Chemical Extinguishing Systems*

NFPA 750—*Water mist fire protection systems*

NATIONAL OCCUPATIONAL HEALTH AND SAFETY COMMISSION

NOHSC:1015 *National Standard for the Storage and Handling of Workplace Dangerous Goods*

SP SVERIGES PROVNINGS- OCH FORSKNINGSINSTITUT

SP-method 2377—*Fire test procedures for water spray fire suppression systems in small machinery spaces*

UNDERWRITERS LABORATORIES

UL 300—*Standard for Fire Testing of Fire Extinguishing Systems for Protection of Restaurant Cooking Areas*

UNITED NATIONS ECONOMIC COMMISSION FOR EUROPE

UN Recommendations on the Transport of Dangerous Goods. Model Regulations

1.10 ABBREVIATIONS**BCA—**

Building Code of Australia

FSS Code—

International Code for Fire Safety Systems (Fire Safety Systems Code) as adopted by resolution MSC.98(73)

FPT Code—

International Code for Application of Fire Test Procedures (Fire Test Procedures Code) as adopted by resolution MSC.61(67)

HSC Code—

International Code of Safety for High Speed Craft 2000

IDG Code—

UN Recommendations on the Transport of Dangerous Goods. Model Regulations

IMDG Code—

IMO International Maritime Dangerous Goods Code

CHAPTER 2 FIRE SAFETY OUTCOMES AND SOLUTIONS

2.1 SCOPE

This Chapter specifies required outcomes and fire safety solutions applicable to vessels.

REQUIRED OUTCOMES

2.2 PREVENTION OF EXPLOSIVE COMBUSTION

A vessel must be designed, constructed and operated to reduce to acceptable levels, or where practicable eliminate, the risks of uncontrolled explosive combustion of vapours, gases, liquids or other substances on board the vessel.

2.3 CONTROL OF RISKS OF SPILLAGE OF FLAMMABLE LIQUIDS

A vessel must be designed, constructed and operated to reduce to acceptable levels, or where practicable eliminate, the risks associated with the spillage of *flammable liquids* on board the vessel.

2.4 CONTROL RISKS OF IGNITION BY SOURCES OF HEAT OR SPARKS

A vessel must be designed, constructed and operated to reduce to acceptable levels, or where practicable eliminate, the risks associated with the sources of heat or sparks on board the vessel.

NOTE: Sources of heat include substances that might be subject to spontaneous combustion under the conditions of loading, storage and use that may exist on board the vessel.

2.5 PREVENTION OF EXPOSURE TO THE SMOKE AND HEAT OF FIRE

A vessel must be designed, constructed and operated to reduce to acceptable levels, or where practicable eliminate, the exposure of persons to the smoke and heat of a fire that might occur on board the vessel.

2.6 PREVENT OR DELAY THE SPREAD OF FIRE

A vessel must be designed, constructed and operated to reduce to acceptable levels, or where practicable eliminate, the rapid spread of fire on board the vessel.

2.7 PROTECTION OF ESSENTIAL SYSTEMS

A vessel must be designed, constructed and operated to reduce to acceptable risk, or where practicable eliminate, the possible disruption or destruction by fire of essential safety systems.

EXAMPLES

Essential safety systems include:

Escape and evacuation

Emergency electrical systems

Fire equipment
 Lifesaving equipment
 Evacuation paths
 Communications equipment

2.8 REDUNDANCY

The combination of fire safety measures on a vessel must have sufficient redundancy, diversity and independence to avoid vulnerability arising from over-reliance on a single measure.

NOTE: See also Clause 1.6.2.

DEEMED-TO-SATISFY SOLUTIONS

2.9 COMPLIANCE

For the purpose of this National Standard, the fire safety measures on a vessel shall be deemed-to-satisfy the Required Outcomes in Clauses 2.2 to 2.8 to the extent specified by this Section if they comply with Table 4.

NOTE: Other Sections of the NSCV have provisions that also pertain to fire safety. See Part C Section 5—Engineering and Part E—Operational Practices.

Table 4 — Deemed-to-satisfy solutions

Vessel use	Operational area					
	Class A excepting tankers		Class B excepting tankers		Class C to E excepting tankers	Tankers
Class 1	$L_m \geq 35$ m	MO 15	$L_m \geq 35$ m	MO 15	NSCV Part C Sec.4	Not permitted
	$L_m < 35$ m	MO 15 (1) or NSCV Part C Sec.4	$L_m < 35$ m	MO 15 (1) or NSCV Part C Sec.4		
Class 2	$L_m \geq 35$ m	MO 15	NSCV Part C Sec.4		NSCV Part C Sec.4	MO 15 (2)
	$L_m < 35$ m	NSCV Part C Sec.4				
Class 3	NSCV Part Sec.4		NSCV Part Sec.4		NSCV Part C Sec.4	MO 15 (2)

KEY:

L_m denotes measured length.

MO 15 denotes that the vessel shall comply with Marine Orders Part 15 Construction—Fire protection, fire detection and fire extinction.

NSCV Part C Sec.4 denotes that the vessel shall comply with the applicable provisions contained in Chapter 3 to Chapter 13 of this Section.

- (1) MO 15 applies to Class I passenger vessels carrying more than 450 day passengers or more than 36 berthed passengers.
- (2) A vessel carrying moderate quantities of *flammable liquids* as cargo may, as an alternative to being arranged as a *tanker*, be arranged to comply with the requirements specified for the carriage of *dangerous goods* specified in Clause 6.6.

EQUIVALENT SOLUTIONS

2.10 ASSESSMENT METHODS

Assessment methods for equivalent solutions applicable to fire safety shall comply with Part B of this National Standard and Annex B of this Section. Equivalent solutions applicable to fire safety shall be verified in a manner appropriate to the risks that would arise should the safety system fail to perform at time of need.

NOTE: Assessment methods (see Part B of this standard) applicable to systems of fire safety tend to be rigorous to promote reliability of performance. Special diligence is needed to avoid the possibility of insufficient or inappropriate equipment being provided at time of need. In addition to the need for rigorous assessment, options for equivalent solutions may be limited by enabling legislation.

AS 5062 Chapters 2 and 3 provides a methodology that can assist in developing equivalent solutions.

2.11 STANDARDS FOR ADDITIONAL EQUIPMENT, WHERE FITTED

Fire safety equipment that is provided on a vessel that is additional to the requirements specified in this section but which may be relied upon in an emergency shall comply with this standard.

NOTE: Compliance is necessary because of the risks associated with the use of inappropriate or unreliable *fire equipment* in an emergency situation and the accidental operation of *fire equipment* in normal situations.

CHAPTER 3 GENERAL REQUIREMENTS FOR PASSIVE FIRE PROTECTION MEASURES

3.1 SCOPE

This Chapter specifies requirements for *passive fire protection measures*. Specific requirements applicable to particular spaces on a vessel are specified in later chapters, see Table 5.

Table 5 — Chapters applicable to specific spaces

Space	Chapter
High Fire Risk Spaces	Chapter 6
Moderate Fire Risk Spaces	Chapter 7
Accommodation Spaces	Chapter 8
Minor Fire Risk Spaces	Chapter 9
Control Stations	Chapter 10
Escape or Evacuation Routes	Chapter 11

PREVENTION OF FIRE AND EXPLOSION

3.2 STORAGE OF COMBUSTIBLE OR FLAMMABLE OILS

Storage for fuel oil, lubrication oil and other *combustible* or *flammable liquids* shall not be located forward of the collision bulkhead.

NOTE: On vessels not required to have a collision bulkhead, storage for fuel oil, lubrication oil and other combustible or flammable liquids should not be located in the forward extremity of the vessel.

3.3 ENGINE EXHAUSTS, BOILER AND GALLEY UPTAKES

Internal combustion engine exhausts, boiler and *galley* uptakes and similar sources of ignition, shall be—

- a) kept clear of any *combustible materials*; and
- b) insulated with *non-combustible* materials where—
 - i) the temperature of an exposed unprotected surface could exceed 93°C; and
 - ii) either—
 - A) persons or equipment, *flammable* or *combustible liquids* or other combustible items may come into contact with the exhaust system; or
 - B) the surface is within 230 mm of any *combustible materials*.

3.4 CERTAIN HIGHLY FLAMMABLE MATERIALS PROHIBITED

Paints, varnishes, or any similar preparations shall not be used if they contain a nitro-cellulose or other highly flammable base. Fabrics containing nitro-cellulose shall not be fitted.

FIRE GROWTH POTENTIAL

3.5 INSULATION

3.5.1 Insulation materials

Except as provided in Clause 3.5.2, insulating materials shall be *non-combustible*. Vapour barriers and adhesives used in conjunction with insulation, as well as the insulation of pipe and fittings for cold service systems, need not be of *non-combustible* materials. They shall be kept to the minimum quantity practicable.

3.5.2 Insulation for sound control or control of ambient temperature

Insulation for sound control or control of ambient temperature shall comply with Table 6 and Chapter 12.

Table 6 — Fire characteristics of insulation for sound control or control of ambient temperature (1)

	<i>High Fire Risk Space</i>	<i>Moderate Fire Risk Space</i>	<i>Minor Fire Risk Space</i>	<i>Other spaces</i>
<i>Fire Risk Category I</i>	Annex I (2)	Annex I	Clause 3.4	Annex I
<i>Fire Risk Category II</i>	NC or LFS	Annex I (2)	Clause 3.4	Annex I
<i>Fire Risk Category III</i>	NC or LFS	NC or LFS	Annex I	Annex I (2)
<i>Fire Risk Category IV</i>	NC or LFS	NC or LFS	Annex I	NC or LFS

KEY:

NC means *non-combustible* material complying with Chapter 12

LFS means *low flame spread* surface complying with Chapter 12

Annex I means a material complying with Chapter 12 and Annex I

(1) Includes insulation for airconditioning, environmental comfort or refrigeration.

(2) Insulation used in conjunction with fire-resisting divisions shall comply with the requirements for fire-resisting divisions in Chapter 12 or the requirements for a combustible veneer under Clause 3.7.4.

3.5.3 Surfaces protected against oil penetration

In spaces where penetration of oil products is possible—

- a) the surface of insulation, including structural fire protection insulation, shall not absorb oil or oil vapours, and
- b) the insulation shall have protection where the insulation is vulnerable to damage.

NOTE: Insulation of the type provided with an impervious outside layer is suitable. Where the insulation is cut, the edges could be protected against impregnation by use of tape having comparable fire characteristics.

SMOKE GENERATION POTENTIAL AND TOXICITY

3.6 PAINTS, VARNISHES & OTHER FINISHES ON PASSENGER VESSELS

For vessels in *Fire Risk Category IV*, paints, varnishes and other finishes used on exposed interior surfaces in all spaces other than *Minor Fire Risk*

Spaces shall not be capable of producing excessive quantities of smoke and toxic products. Such finishes shall comply with Chapter 12.

CONTAINMENT OF FIRE

3.7 STRUCTURAL FIRE PROTECTION

3.7.1 Protection of boundaries

Depending upon the *Fire Risk Category* applicable to the vessel as determined from Table 2, the boundaries of spaces shall be protected by *fire-resisting divisions* to the extent required by Table 7, Table 8 or Table 9.

Spaces that are in proximity to one another, but which are not necessarily adjacent, shall be considered to be adjacent if the intervening space would not provide levels of protection equivalent to that required if the spaces had been adjacent.

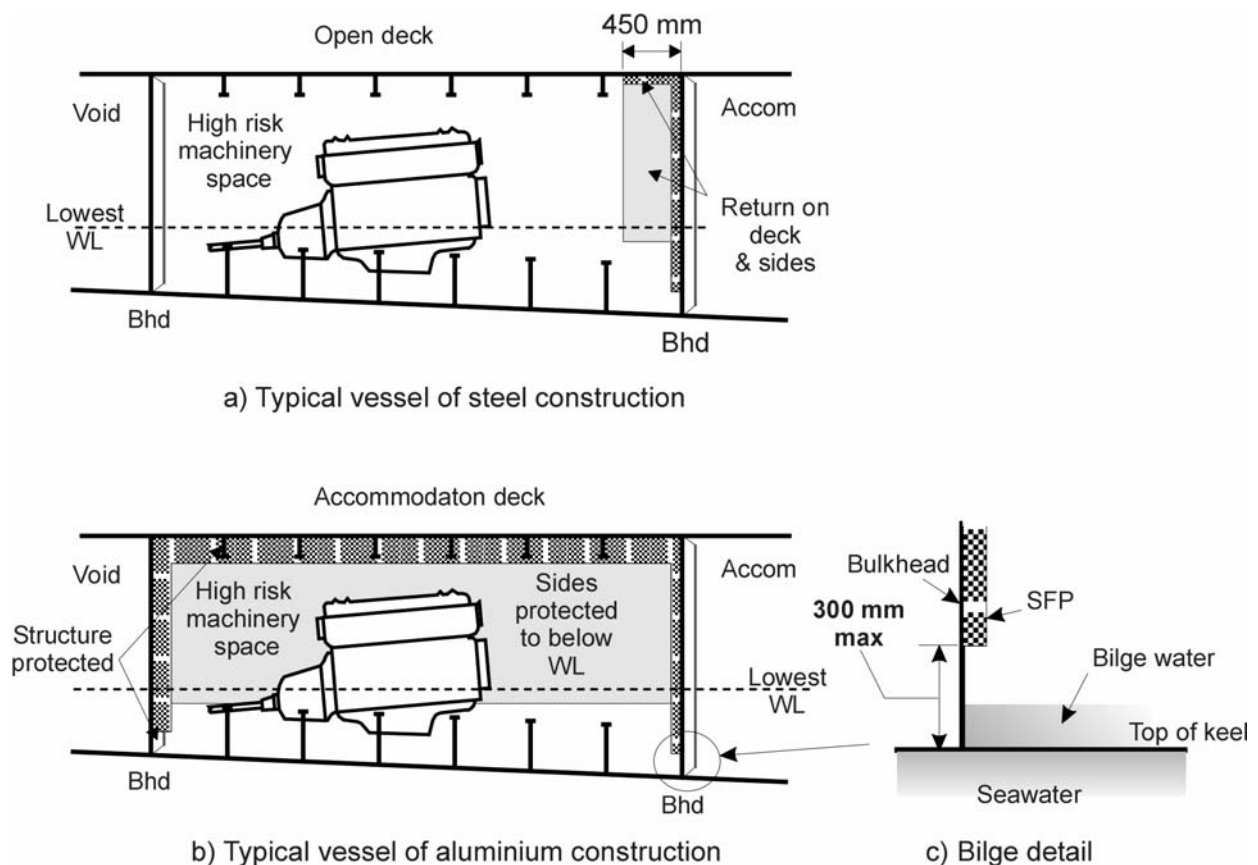

Figure 3 — Structural fire protection details

3.7.2 Returns at the edges of fire-resisting divisions

The insulation of a deck, bulkhead or structural member that is part of a *fire-resisting division* shall be carried past a penetration, intersection or terminal point for the distance necessary to prevent the transmission of excessive levels of heat into the adjacent structure. Where there is an

intersection by a deck or bulkhead of different values, the insulation with the higher value shall continue on the deck or bulkhead with the insulation of the lesser value for the required distance. A distance on the return of not less than 450 mm shall be deemed-to-satisfy, see Figure 3(a).

3.7.3 Arrangements to accommodate drainage

Where the lower end of a fire-resisting bulkhead terminates on the immersed bottom shell in the bilge, the insulation may be terminated a distance not exceeding 300 mm above the top of keel as shown in Figure 3(c).

Table 7 — Structural fire protection for *Fire Risk Category I*

Category of space		High Fire Risk Spaces	Moderate Fire Risk Spaces	Accommodation Spaces	Minor Fire Risk Spaces	Control Stations	Escape or Evacuation Routes
		1	2	3	4	5	6
High Fire Risk Spaces	1	30 (2)	ST	ST	ST	ST	ST
		30 (1)(2)(4)	30 (1)(4)	30 (1)(4)	30 (1)(3)(4)	30 (1)(4)	30 (1)(4)
Moderate Fire Risk Spaces	2		ST (2)	Nil	Nil	Nil	Nil
			ST (2)	Nil	Nil	Nil	Nil

NOTES:

The value above the diagonal line in a cell applies to the side of the bulkhead or deck exposed to the category of space corresponding to the vertical column. For steel divisions, the *time rating* above the diagonal line need not apply.

The value below the diagonal line in a cell applies to the side of the bulkhead or deck exposed to the category of space corresponding to the horizontal row.

Definitions for the various Categories of Space are described in Clause 1.8.

LEGEND:

ST refers to a division not being a *fire-resisting division* but which is *smoke-tight*.

30 means a 30-minute *time rated fire-resisting division*.

KEY:

- (1) The upper side of the decks of Ro-Ro spaces protected by an aqueous *fixed fire-extinguishing system* need not be insulated.
- (2) A *fire-resisting division* or *smoke-tight* bulkhead or deck between such spaces need not be fitted if omitting the division would not materially affect the safety of the vessel. For example, a bulkhead may not be required between 2 storerooms. A *fire-resisting division* is required between a machinery space and a *Ro-Ro space* even though both spaces are in the same category.
- (3) When steel construction is used, *fire-resisting divisions* adjacent to void spaces or diesel fuel tanks need only be *smoke-tight* without insulation.
- (4) Certain vessels may only require a *smoke-tight* division for a machinery space of *High Fire Risk*, refer to Clause 6.4.11.

Table 8 — Structural fire protection for *Fire Risk Category II*

Category of space		High Fire Risk Spaces	Moderate Fire Risk Spaces	Accommodation Spaces	Minor Fire Risk Spaces	Control Stations	Escape or Evacuation Routes
		1	2	3	4	5	6
High Fire Risk Spaces	1	30 (2)	15	ST	ST	ST (3)	ST
		30 (1)(2)	30 (1)	30 (1)	30 (1)(5)	30 (1)	30 (1)(4)
Moderate Fire Risk Spaces	2		15 (2)	ST	ST	ST (3)	ST
			15 (2)	15	15 (5)	15	15 (4)
Accommodation Spaces	3			ST (2)	ST	ST (3)(6)	ST
				ST (2)	ST	ST (6)	ST (4)
Minor Fire Risk Spaces	4	LEGEND: ST refers to a division not being a <i>fire-resisting division</i> but which is <i>smoke-tight</i> . 15 means a 15-minute <i>time rated fire-resisting division</i> . 30 means a 30-minute <i>time rated fire-resisting division</i> . Definitions for the various Categories of Space are described in Clause 1.8.			ST (2)	ST (3)	ST
Control Stations	5				ST (2)	ST	ST (4)
						ST (2)(3)	ST
Escape or Evacuation Routes	6						Nil
							Nil

NOTES:

The value above the diagonal line in a cell applies to the side of the bulkhead or deck exposed to the category of space corresponding to the vertical column. For steel divisions, the *time rating* above the diagonal line need not apply.

The value below the diagonal line in a cell applies to the side of the bulkhead or deck exposed to the category of space corresponding to the horizontal row.

KEY:

- (1) The upper side of the decks need not be insulated in *Ro-Ro spaces* and spaces of *Moderate Fire Risk* other than machinery spaces provided the entire space is protected by an aqueous *fixed fire-extinguishing system* complying with Chapter 12.
- (2) A *fire-resisting division* or *smoke-tight* bulkhead or deck between such spaces need not be fitted if omitting the division would not materially affect the safety of the vessel. For example, a bulkhead may not be required between 2 storerooms. A *fire-resisting division* is required between a machinery space and a *Ro-Ro space* even though both spaces are in the same category.
- (3) Control Stations that contain auxiliary machinery for emergency purposes shall be provided with a 15-minute *fire-resisting division*.
- (4) Refer to Clause 8.14 for requirements for stairways penetrating decks.
- (5) When steel construction is used, *fire-resisting divisions* adjacent to void spaces or diesel fuel tanks need only be *smoke-tight* without insulation.
- (6) Not required for an *operating compartment* on a vessel carrying less than 200 passengers, refer to Clause 10.6.

Table 9 — Structural fire protection for *Fire Risk Category III* and *IV*

Category of space		High Fire Risk Spaces	Moderate Fire Risk Spaces	Accommodation Spaces	Minor Fire Risk Spaces	Control Stations	Escape or Evacuation Routes
		1	2	3	4	5	6
High Fire Risk Spaces	1	60 (2)	30	STNF	STNF	STNF (3)	STNF
		60 (1)(2)	60 (1)	60 (1)	60 (1)(5)	60 (1)	60 (1)(4)
Moderate Fire Risk Spaces	2		30 (2)	STNF	STNF	STNF (3)	STNF
			30 (2)	30	30 (5)	60	30 (4)
Accommodation Spaces	3			STNF (2)	STNF	STNF(3)(7)	STNF
				STNF (2)	STNF	30 (7)	30 (4)(6)
Minor Fire Risk Spaces	4				STNF (2)	STNF (3)	STNF
Control Stations	5				STNF (2)	30 (5)	STNF (4)
						STNF (2)(3)	STNF
Escape or Evacuation Routes	6					STNF (2)(3)	STNF (3)(4)
							Nil
		<p>LEGEND:</p> <p>STNF refers to a division not being a <i>fire-resisting division</i> but which is <i>smoke-tight</i> and constructed of <i>non-combustible</i> or <i>fire-restricting material</i>.</p> <p>30 means a 30-minute <i>time rated fire-resisting division</i>.</p> <p>60 means a 60-minute <i>time rated fire-resisting division</i>.</p> <p>Definitions for the various Categories of Space are described in Clause 1.8.</p>					

NOTES:

The value above the diagonal line in a cell applies to the side of the bulkhead or deck exposed to the category of space corresponding to the vertical column. For steel divisions, the *time rating* above the diagonal line need not apply (see Clause 4.2.8 above).

The value below the diagonal line in a cell applies to the side of the bulkhead or deck exposed to the category of space corresponding to the horizontal row.

KEY:

- (1) The upper side of the decks need not be insulated in *Ro-Ro spaces* and spaces of *Moderate Fire Risk* other than machinery spaces provided the entire space is protected by an aqueous *fixed fire-extinguishing system* complying with Chapter 12.
- (2) A *fire-resisting division* or *smoke-tight* bulkhead or deck between such spaces need not be fitted if omitting the division would not materially affect the safety of the vessel. For example, a bulkhead may not be required between 2 storerooms. A *fire-resisting division* is required between a machinery space and a *Ro-Ro space* even though both spaces are in the same category.
- (3) *Control Stations* that contain auxiliary machinery for emergency purposes shall be provided with a 30 minute *fire-resisting division*.
- (4) Refer to Clause 8.14 for requirements for stairways penetrating decks.
- (5) When steel construction is used, *fire-resisting divisions* adjacent to void spaces or diesel fuel tanks need only be *smoke-tight* without insulation.
- (6) Division can be reduced to STNF where the *Accommodation Space* does not include sleeping rooms.
- (7) Not required for an *operating compartment* on a vessel of *Fire Risk Category III* carrying less than 200 passengers, refer to Clause 10.6.

3.7.4 Combustible veneers

Combustible veneers are permitted on non-combustible and fire-resisting divisions, provided that they satisfy the requirements for a low flame spread surface. See also Clause 8.6.3.

3.8 PENETRATIONS IN FIRE-RESISTING DIVISIONS

3.8.1 General

Penetrations through *fire-resisting divisions* shall be designed and installed to prevent the transmission of fire, heat and smoke through the division.

3.8.2 Testing of penetrations

Except as provided in Clauses 3.8.3, 3.8.5.2 and 3.8.6.5, penetrations through *fire-resisting divisions* shall be tested in accordance with Chapter 12.

3.8.3 Pipe penetrations

The minimum melting temperature of pipes in *High Fire Risk Spaces* or *Moderate Fire Risk Spaces* that penetrate *time rated fire-resisting divisions*, including uninsulated metallic pipes, shall be in accordance with Table 10.

A pipe penetration made of steel or equivalent material is deemed-to-satisfy the requirement of Clause 3.8.1 without the testing required under Clause 3.8.2 provided the pipe—

- a) has a thickness of 3 mm or greater;
- b) has a length of not less than 900 mm;
- c) has no openings; and
- d) is suitably insulated by extension of the insulation of the same *time rating* as the division.

Table 10 — Minimum melting temperatures of uninsulated pipes in spaces of *High Fire Risk* or *Moderate Fire Risk* that penetrate *time rated fire-resisting divisions*

<i>Time rating of fire-resisting division</i> Min.	Minimum melting temperature of pipe material Degrees C	
	<i>High Fire Risk Spaces</i>	<i>Moderate Fire Risk Spaces</i>
15	No application	650°C
30	850°C	850°C
60	950°C	No application

3.8.4 Lifts and dumb-waiters

Trunks for lifts and dumb-waiters shall be—

- a) constructed to maintain the fire integrity of boundaries specified in Clause 3.7; and
- b) provided with a means of closing that permits the control of draught and smoke.

Where the machinery for lifts and dumb-waiters falls within the criteria for a space of *Moderate Fire Risk* under Clause 1.8, the machinery shall be arranged in a separate room, to be considered as a space of *Moderate Fire Risk*, except that small openings for lift cables are permitted.

3.8.5 Ventilation ducts

3.8.5.1 General

Ventilation ducts shall be arranged, constructed and installed to maintain the effectiveness of *fire-resisting divisions* within the vessel.

NOTE: Measures that satisfy this Clause include the use of *non-combustible* materials for ducts, the incorporation of *fire flaps* at divisions and/or structural insulation of ducts.

3.8.5.2 Testing

The tests specified in Clause 3.8.2 shall apply to the penetrations of ventilation ducts and shall include tests of the—

- a) *fire dampers* and their relevant means of operation; and
- b) duct penetrations through *fire-resisting divisions*.

However, test b) is not required where—

- i) the penetration is fitted with a steel sleeve of thickness not less than 3 mm, see Figure 4(a);
- ii) portions of the ventilation duct where the contents are intended to be kept separate from the space are directly joined to the sleeve by means of riveted or screwed flanges, or by welding; and
- iii) if the *fire-resisting division* is *time rated*, the steel sleeve—
 - i) extends no less than 450 mm on the insulated side of the division; and
 - ii) has no openings to enable the duct to be suitably insulated by extension of the insulation of the same *time rating* as the division.

3.8.5.3 Separation of systems

The ventilation systems for *High Fire Risk Spaces*, *Moderate Fire Risk Spaces* and cargo shall be separated from each other and from the ventilation systems serving other spaces.

3.8.5.4 Ducts passing through Accommodation Spaces or Control Stations

Ducts provided for the ventilation of *High Fire Risk Spaces* or *Moderate Fire Risk Spaces* shall not pass through *Accommodation Spaces* or *Control Stations* unless the ducts are constructed and insulated so that a fire in the high or moderate risk space will have no adverse effect on these latter spaces for a period equivalent to the applicable *time rating* from Table 7, Table 8 or Table 9.

NOTE: Guidance on the construction and insulation of ducts is provided in SOLAS Chapter II-2.

3.8.5.5 Ducts passing through High Fire Risk Spaces and Moderate Fire Risk Spaces

Ducts provided for ventilation to *Accommodation Spaces* or *Control Stations* shall not pass through *High Fire Risk Spaces* or *Moderate Fire Risk Spaces* unless the ducts are constructed and insulated such that a fire in the high or moderate risk space will have no adverse effect on these latter spaces for a period equivalent to the applicable *time rating* from Table 7, Table 8 or Table 9. Figure 4(b) illustrates the arrangement of insulation.

NOTE: Guidance on the construction and insulation of ducts is provided in SOLAS Chapter II-2.

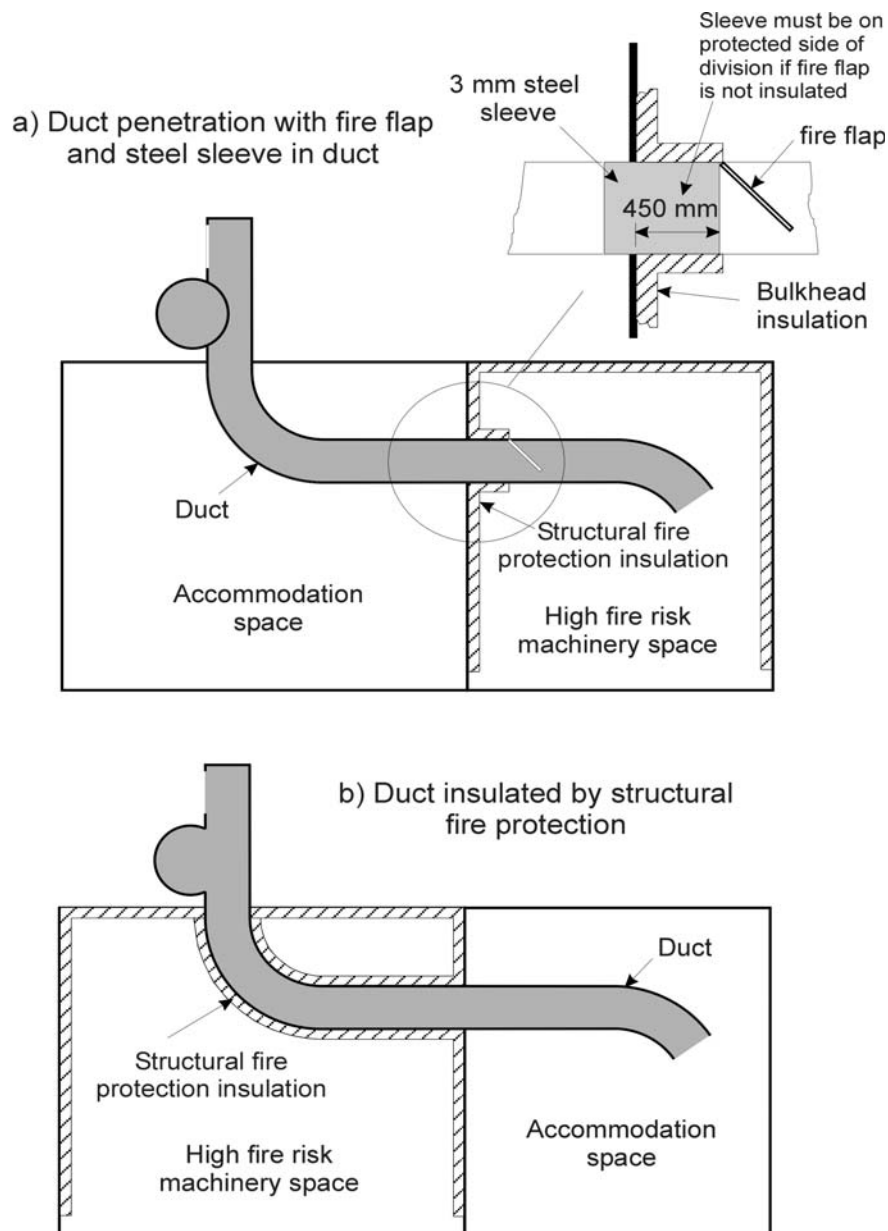

Figure 4 — Ducts, duct penetrations and fire flaps

3.8.5.6 Dampers on ducts passing through fire-resisting divisions

3.8.5.6.1 Fire integrity of division to be maintained

Where a ventilation duct passes through a *fire-resisting division*, a closing *fire damper* shall be fitted adjacent to the division [Figure 4(a)] unless the duct is completely protected by insulation. The duct between the division and the *fire damper* shall be of steel or other equivalent material and insulated to the same standard as required for the *fire-resisting division*. The *fire damper* may be omitted where ducts pass through spaces surrounded by *fire-resisting divisions* without serving those spaces providing that the duct has the same structural fire protection *time rating* as the divisions it penetrates.

NOTES:

1. Guidance on the design of duct sleeves is provided in SOLAS Chapter II-2 Regulation 9.7.3.1.
2. A proposal to incorporate intumescent *fire dampers* should address the need to reinstate ventilation within a space after a fire if that were required for the safety of persons or the vessel.

3.8.5.6.2 Manual operation

All *fire dampers* fitted on *fire-resisting divisions* shall be capable of being manually closed. *Fire dampers* fitted on ducts serving spaces not normally manned such as stores and toilets may be manually operated only from outside the served spaces. For other *fire dampers*, the arrangements for manual closure shall allow manual operation from each side of the division in which they are fitted.

On passenger vessels required to have centralised fire control functions under Clause 4.4, *fire dampers* on *fire-resisting divisions* shall also be capable of being remotely closed from a normally continuously manned central control station.

3.8.5.6.3 Automatic operation

For vessels of *Fire Risk Category IV*, the *fire damper* on *fire-resisting divisions* shall be of a fail-safe, automatic closing type that is also capable of manual closure.

3.8.5.7 Dampers on ducts passing through smoke-tight divisions

Where a ventilation duct serves an *Accommodation Space*, *Escape or Evacuation Route*, or *Control Station*, and that ventilation duct passes through a *smoke-tight* division; a manually operated smoke damper shall be fitted at the penetration of the ventilation duct through the *smoke-tight* division. The smoke damper shall be operable from the space served by the ventilation duct.

3.8.6 Doors, hatches and other openings in fire-resisting divisions

3.8.6.1 General

Openings in *fire-resisting divisions* shall be provided with a permanently attached means of closing and shall be at least as effective for resisting fires as the divisions in which they are fitted.

3.8.6.2 Performance of doors

The construction of doors and door frames in *fire-resisting divisions*, with the means of securing them when closed, shall provide resistance to fire as well as to the passage of smoke and flame equivalent to that of the bulkheads in which the doors are situated. Resistance shall be determined in accordance with Chapter 12. Steel sliding watertight doors penetrating bulkheads below the bulkhead deck need not be insulated.

3.8.6.3 Operation of doors

Each door shall be able to be opened and closed from each side of the bulkhead by one person only.

3.8.6.4 Windows and sidescuttles

Windows and sidescuttles in *fire-resisting divisions*, other than those to which the provisions of Clause 3.8.6.5 apply, shall be constructed to preserve the fire integrity requirements of the type of bulkheads in which they are fitted. Fire integrity shall be determined in accordance with Chapter 12.

3.8.6.5 Penetrations through divisions on outer boundaries of a vessel

For spaces other than *High Fire Risk Spaces* the requirements for *fire-resisting divisions* on the outer boundaries of a vessel need not apply to doors, glass partitions, windows and sidescuttles, except for those in superstructures and deckhouses facing lifesaving appliances, embarkation and external assembly station areas, external stairs and open decks used for escape routes, and windows situated below a survival craft or marine evacuation system (MES) embarkation area.

STRUCTURAL INTEGRITY

3.9 MAINTENANCE OF STRUCTURAL INTEGRITY

3.9.1 General requirement

A structure either bounding or within a space of *High Fire Risk* or *Moderate Fire Risk*; or supporting an adjacent *Control Station* or *Escape or Evacuation Route*, shall be constructed or protected so that, when exposed to fire for the time required for structural fire protection of the space in Table 7, Table 8 or Table 9, its structural integrity is maintained. This integrity shall be sufficient to avoid—

- a) a loss of watertight integrity of the vessel that could endanger persons on the vessel;
- b) a partial or total collapse of the vessel's structure that could endanger persons on the vessel; or

EXAMPLES:

Unprotected structural pillars supporting decks carrying survival craft above a space.

Unprotected side structure of an aluminium hull above the waterline within a space of *High Fire Risk* or *Moderate Fire Risk*.

NOTE: Unprotected structures of steel are taken to satisfy this Clause.

3.9.2 Structures of aluminium alloy

If the structures specified in Clause 3.9.1 are made of aluminium alloy their installation shall be such that the temperature of the core shall not rise more than 200°C above the ambient temperature during exposure to the standard fire test in Chapter 12. The time of exposure to the standard fire test shall be determined from Table 7, Table 8 or Table 9. See also Figure 3b).

3.9.3 Structures of combustible materials

If the structures specified in Clause 3.9.1 are made of *combustible material*, their construction or insulation shall be such that load-carrying capability will not deteriorate to the extent that structural failure of the member could occur when exposed to the standard fire test in Chapter 12. The time of exposure to the standard fire test shall be determined from Table 7, Table 8 or Table 9.

3.9.4 Structures in contact with water

Where for the purposes of Clause 3.9.1, the proximity of the structure to seawater is taken to provide sufficient protection against the effects of exposure of hull structure to the heat of a fire, the arrangement of structural fire protection shall—

- a) provide protection at all normal conditions of loading including the lightweight condition; and
- b) take into account the effect of temperature on the hull and hull stiffening in contact with water and heat transfer from any uninsulated structure in contact with water to insulated structure above the water.

NOTE: Insulation of hull sides to a level 300 mm below the design lightweight waterline provides a factor of safety should a discrepancy arise once the vessel is constructed, see Figure 3b).

3.10 MATERIALS FOR OVERBOARD FITTINGS

Overboard scuppers, sanitary discharges, and other outlets within spaces of *High Fire Risk* or *Moderate Fire Risk* that are 230 mm or less above the deepest load waterline shall be constructed of materials resistant to exposure to heat where the failure of the material in the event of fire would give rise to unacceptable risks associated with flooding.

CHAPTER 4 GENERAL REQUIREMENTS FOR ACTIVE FIRE PROTECTION MEASURES

4.1 SCOPE

This Chapter specifies requirements for *active fire protection measures*. Specific requirements applicable to particular spaces on a vessel are specified in later chapters, see Table 11.

Table 11 — Chapters applicable to specific spaces or types of vessels

Space	Chapter
High Fire Risk Spaces	Chapter 6
Moderate Fire Risk Spaces	Chapter 7
Accommodation Spaces	Chapter 8
Minor Fire Risk Spaces	Chapter 9
Control Stations	Chapter 10
Escape or Evacuation Routes	Chapter 11

FIRE GROWTH POTENTIAL

4.2 REMOTE STOPS FOR VENTILATION AND EXHAUST FANS

All vessels shall be provided with remote stops for ventilation and exhaust fans that supply *High Fire Risk Spaces*, *Moderate Fire Risk Spaces*, *Accommodation Spaces*, and cargo spaces. These remote stops shall be sited outside the spaces in which such fan machinery is located.

4.3 VENTILATION CLOSING APPLIANCES

The main inlets and outlets of all ventilation systems shall be capable of being effectively sealed by fire flaps from outside the spaces being ventilated. The fire flaps shall be easily accessible as well as prominently and permanently marked, and shall indicate whether the fire flap is open or closed.

NOTE: Clause 3.8.5 specifies requirements for *fire dampers* in ventilation ducts.

4.4 CENTRALISED FIRE CONTROL FUNCTIONS ON PASSENGER VESSELS

Vessels specified in Table 12 shall be arranged with a *central control station* in the *operating compartment* or another normally continuously manned *Control Station* having a safe access from the open deck. The *central control station* shall contain remote indicators and controls for monitoring and operating the equipment listed in Table 13, to the extent that such equipment is fitted on the particular vessel.

The control panel shall be continuously powered and shall have an automatic changeover to standby power supply in case of loss of normal power.

NOTE: IMO Resolution A.830(19) specifies types of alarms and indicators for various functions.

Table 12 — Grouping of remote shut-downs and controls

Category	Application
<i>Fire Risk Category I</i>	Not required
<i>Fire Risk Category II</i>	Not required
<i>Fire Risk Category III</i>	Applies to vessels carrying more than 450 day passengers.
<i>Fire Risk Category IV</i>	Applies

Table 13 — Functions centralised in a *central control station*

Equipment	Functions
<i>Fixed fire detection and fire alarm systems</i>	Indicators and controls
<i>Fixed fire extinguishing systems</i>	Indicators and controls
General and evacuation alarms	Controls
Main fire pumps	Controls
Fire doors	Indicators and closures
Machinery space and other <i>High Fire Risk Space fire flaps and fire dampers</i>	Indicators and closures
Watertight doors	Indicators and closures
Ventilation fans	Indicators and controls
Fuel transfer pumps, fuel pumps, lubricating oil service pumps, thermal oil circulating pumps, oil separators	Remote stops
Communication systems including telephones	Operation and controls
Public address systems	Operation and controls

FIRE DETECTION AND ALARM

4.5 FIRE DETECTION AND FIRE ALARM SYSTEM

4.5.1 Application

A *fire detection and fire alarm system* shall be provided within spaces on vessels as specified in Chapter 6 to Chapter 11. Relevant clauses are listed in Table 14.

NOTE: Not all vessels are required to be fitted with *fire detection and fire alarm system*, for example, some dumb barges and other vessels of relatively low fire risk.

Table 14 — Clauses for determining a requirement to fit *fire detection and fire alarm systems*

Location	Clause
High Fire Risk Machinery Spaces	6.4.12
Ro-Ro Spaces	6.5.6
Moderate Fire Risk Machinery Spaces	7.4.2
Accommodation Spaces	8.11, 8.15
Cargo Spaces	9.4.5
Control Stations	10.7
Escape and Evacuation	11.9

4.5.2 System to be suited to application

The *fire detection and fire alarm system* shall be suited to the nature of the space, the fire growth potential in the space and the potential generation of smoke and gases within the space.

4.5.3 Standard

The *fire detection and fire alarm system* shall comply with Chapter 12.

4.5.4 Fixed fire detection and fire alarm system

4.5.4.1 Alarms

A *fixed fire detection and fire alarm system* shall provide audible and visual alarms. These alarms shall be easily distinguished from other alarms that do not indicate fire. The alarms shall be located so that they can be monitored from the *operating compartment* and in such other places to ensure a responsible member of the crew hears them when the *operating compartment* is unmanned.

4.5.4.2 Class 1 passenger vessels

For Class 1 vessels of *Fire Risk Category* II, III or IV, the *fixed fire detection and fire alarm system* shall be of the self-monitored type.

NOTE: A self-monitored system is designed on the fail-safe principle to self-check for loss of system functionality (i.e. an open detector circuit triggers an alarm).

MEANS OF ESCAPE

4.6 EMERGENCY ESCAPE BREATHING DEVICES

4.6.1 General

Emergency escape breathing devices shall comply with Chapter 12.

4.6.2 Number of emergency escape breathing devices

Emergency escape breathing devices shall be provided on vessels in accordance with Table 15.

Table 15 — Emergency escape breathing devices required

Category	Vessels of less than 35 m measured length	Vessels of 35 m or more and less than 80 m measured length	Vessels of 80 m measured length & more	
		Each <i>High Fire Risk</i> machinery space: manned or with a machinery <i>Control Station</i>	Each <i>High Fire Risk</i> machinery space	Each <i>Accommodation Space</i> for berthed persons located below the bulkhead deck
<i>Fire Risk Category I</i>	Not required	2	2	2
<i>Fire Risk Category II</i>	Not required	2	2	2
<i>Fire Risk Category III</i>	Not required	2	2	2
<i>Fire Risk Category IV</i>	Not required	2	As per SOLAS	As per SOLAS

4.6.3 Storage of emergency escape breathing devices

Where emergency escape breathing devices are provided they shall be situated ready for use at easily visible places so they can be reached quickly and easily at any time. Emergency escape breathing devices shall be located along the escape routes, at the foot of escape ladders or in control spaces or workshops located within the space, taking into account the layout of the space and the location of persons normally within the space.

NOTE: Guidelines for the performance, location, use and care of emergency escape breathing devices are published as MSC/Circ.849.

FIRE FIGHTING

4.7 FIRE HOSE APPLIANCES

4.7.1 Application

Table 16 specifies those vessels that shall be provided with fire hose appliances supplied by fire pumps. Vessels not required to be fitted with fire hose appliances shall carry fire buckets in accordance with Clause 4.8.

Table 16 — Application of fire hose appliance requirements

Category	Application
<i>Fire Risk Category I</i> (1)	Required if the Measured length x breadth $\geq 66 \text{ m}^2$
<i>Fire Risk Category II</i> (1)	Required if the Measured length x breadth $\geq 66 \text{ m}^2$
<i>Fire Risk Category III</i>	Required
<i>Fire Risk Category IV</i>	Required

KEY:

(1) Vessels of *Fire Risk Category I* or *II* that have no spaces of *High Fire Risk* or *Moderate Fire Risk* and no enclosed *Accommodation Spaces* need not be provided with fire hose appliances.

4.7.2 Performance

4.7.2.1 General

Each fire hose appliance shall consist of a hose complying with Clause 4.7.6.2 and a nozzle complying with Clause 4.7.6.3. When attached to any fire hydrant on a vessel, each fire hose appliance shall achieve and maintain a flow rate and inclined jet throw not less than the values specified in Table 17.

NOTE: Rigid cross-section hoses have improved flow and throw performance over lay flat hoses.

Table 17 — Fire hose appliance performance

Vessel measured length x breadth m ²	Single orifice nozzle diameter (1) mm	Minimum throw of inclined water jet m	Assumed hydrant pressure kPa	Minimum fire hose nozzle flow rate m ³ /hr	Minimum pump capacity per fire hose appliance per fire pump m ³ /hr
< 100	10	6	Not specified	Not specified	5.5
≥ 100 and < 1900	12	11	150	6.5	7.0
≥ 1900 and < 3400	16	14	150	10.5	12.5
≥ 3400	19	19	200	17.0	20.4

KEY:

Clause 4.7.6.3.1 specifies equivalent minimum flow rates for nozzles other than single orifice type of 12 mm diameter or more.

4.7.2.2 Testing

The fire hose appliances, fire pumps and fire main piping shall be tested to verify—

- a) the operation of each fire pump;
- b) the integrity of fire main piping while under pressure;
- c) the supply of water to every hydrant; and
- d) the performance of the fire main appliances by either of the following tests:
 - i) For vessels with no more than two hydrants on the fire main, a practical test shall be undertaken to determine the throw of the fire hose jet. The test shall be in accordance with Annex C with the requisite number of fire hose jets operating using the nozzle and single length of hose stowed at the relevant hydrant or hydrants. The throw so determined shall not be less than the greater of required value in Table 17 or the throw corresponding specified by the nozzle manufacturer corresponding to the required minimum flow rate specified in Table 17. Practical tests shall be undertaken to verify the proper functioning of *fire appliances* on the vessel that are supplied with water by the fire main; e.g., dual function nozzles, fire hose reels and foam-making branch pipes.

- ii) A test to determine the pressure at the most hydraulically-disadvantaged hydrant with the requisite number of fire hose jets operating using the nozzle and single length of hose stowed at the relevant hydrant or hydrants. The pressure so determined shall not be less than the greater of the applicable assumed pressure in Table 17 and the minimum required value specified by the nozzle manufacturer for the nozzle to provide the flow rate specified in Table 17. Practical tests shall be undertaken to verify the proper functioning of *fire appliance* on the vessel that are supplied with water by the fire main; e.g., dual function nozzles, fire hose reels and foam-making branch pipes.

NOTES:

1. A test that measures actual flow rate may provide an equivalent solution for testing the performance of fire hose appliances.
2. For small fire hose appliances having a single orifice nozzle of 10 mm diameter or equivalent, no minimum flow rate or hydrant pressure is specified. The fire hose appliance performance test need only measure throw and test the proper functioning of fire appliances that are supplied with water by the fire main.

4.7.3 Main fire pumps

4.7.3.1 Power source

The source of power of main fire pumps shall be as specified in Table 18.

Table 18 — Source of power of main fire pumps

Vessel measured length x breadth m ²	Fire Risk Category I or II	Fire Risk Category III or IV
< 100	Manually operated or power driven	Power driven
≥ 100 and < 1900	Power driven	Power driven
≥ 1900 and < 3400	Power driven	Power driven
≥ 3400	Power driven	Power driven

4.7.3.2 Multiple operation of fire hose appliances

Each main fire pump shall be sized to simultaneously supply the number of fire hose appliance water jets specified in Table 19, while maintaining the performance of fire hose appliances as specified in Table 17.

4.7.3.3 Capacity of each main fire pump

The capacity of each power driven main fire pump shall be determined by multiplying the number of water jets required in Table 19 by the required minimum pump capacity per fire hose appliance per main fire pump specified in Table 17; i.e.

$$\text{Capacity of each pump} = \frac{\text{Number of water jets} \times \text{Min. pump capacity}}{\text{(Table 19)} \quad \text{(Table 17)}}$$

EXAMPLE

For a vessel of Fire Risk Category IV having Length = 33 m and Breadth = 13 m

$$L \times B = 33 \text{ m} \times 13 \text{ m} = 429 \text{ m}^2$$

$$\text{Required capacity of each pump} = 2 \times 7 \text{ m}^3/\text{hr} = 14 \text{ m}^3/\text{hr}$$

NOTE: Bilge pumps should be sized with a capacity of not less than 1.5 times that of the largest fire pump on the vessel to prevent water accumulating within the vessel while fighting a fire with fire hose appliances.

4.7.3.4 Number of pumps

The number of main fire pumps provided on a vessel shall be as specified in Table 19. Where a single main fire pump is fitted the fire pump shall be operated by a means other than the vessel's propulsion engines.

NOTE: Multiple main fire pumps are intended to provide redundancy in the event of one pump failing. The capacity of each main fire pump is sized to fulfil the required performance for fire hose appliances.

Table 19 — Jets and pumps for fire hose appliances

Category	Number of water jets	Number of main fire pumps
<i>Fire Risk Category I</i>	1 (A)(D)	1 (B)
<i>Fire Risk Category II</i>	1 (A)(D)	1 (B)(C)
<i>Fire Risk Category III</i>	1 (A)(D)	2
<i>Fire Risk Category IV</i>	2 (D)	2

KEY:

- (A) The fire hose appliances shall be capable of supplying 2 water jets on vessels fitted with *Ro-Ro spaces* or *helidecks*.
- (B) *Fire Risk Category I* and *II* vessels that have no spaces of *High Fire Risk* or *Moderate Fire Risk* and no enclosed *Accommodation Spaces* need not be provided with fire hydrant appliances.
- (C) An emergency fire pump shall be fitted on vessels where the single main fire pump or its source of power is located in a machinery space of *High Fire Risk*, see Clause 4.7.4.
- (D) For vessels that carry *dangerous goods*, refer to Clause 6.6.4.

4.7.3.5 Period of operation for main fire pumps

The main fire pumps and their source of power shall be capable of continuous operation for a period not less than that specified for continuous operation of emergency electrical installations under NSCV Part C Subsection 5B. For vessels fitted with multiple main fire pumps, this requirement shall apply to any one of the main fire pumps that may be called upon to supply fire hydrant appliances.

4.7.3.6 Non-dedicated main fire pumps

Pumps used for other purposes may also serve as main fire pumps provided they are not—

- a) bilge pumps; or

- b) pumps normally used for pumping oil or other combustible or *flammable liquids*.

EXAMPLE:

Sanitary, ballast or general service pumps may also serve as main fire pumps.

4.7.3.7 Multiple main fire pumps—requirements for redundancy

Where two main fire pumps are specified in Table 19, they shall—

- a) be driven independently from one another so that a failure in the source of power for one main fire pump, including any switchboard, will not prevent the starting and use of the other;
- b) be arranged so that in the event of fire in any one space at least one main fire pump shall continue to be functional; i.e., they shall be located in different spaces;
- c) where one of the main fire pumps is located in a machinery space of *High Fire Risk*, be provided with valves that isolate the fire hose appliance piping from the machinery space and are operable from an easily accessible position outside the machinery space (see Clause 4.7.5.8); and
- d) each have a capacity sufficient to provide water of the quantity and pressure required in Clause 4.7.2.

4.7.3.8 Sea suction

The sea suction inlet to each main fire pump shall be—

- a) located to draw water without interruption under all conditions of loading and trim of the vessel, and under weather conditions liable to be encountered in service; and
- b) arranged to prevent the entry of objects that would block the pump.

4.7.3.9 Priming of main fire pumps

Unless otherwise specified in this section, main fire pumps shall be self-priming or capable of holding prime. Main fire pumps that are required in Table 19 to have automatic or remote starting shall be self-priming.

4.7.3.10 Automatic or remote starting of main fire pumps

Vessels of *Fire Risk Category III* carrying more than 36 berthed passengers, or 450 day passengers, and all vessels of *Fire Risk Category IV* shall have at least one main fire pump arranged so that it will start either—

- a) automatically; or
- b) remotely from a *central control station*.

4.7.3.11 Manually operated fire pumps

4.7.3.11.1 Performance

Where a manually operated fire pump is installed, it shall meet the requirements of Clause 4.7.2 when using the rate of pumping specified in Table 20.

NOTE: The application of manually operated fire pumps under Clauses 4.7.3.1 and 4.7.4.2 is limited to smaller vessels because of the difficulties likely to be encountered achieving the required performance on large vessels, especially where there is a significant head to the highest hydrant.

Table 20 — Pumping rates for manually operated fire pumps

Manual pump type	Pumping actions per minute
Full rotary	60 turns
Horizontal reciprocating or diaphragm—double acting	80 single strokes
Horizontal reciprocating or diaphragm—single acting	60 double strokes

4.7.3.11.2 Priming of manually operated fire pumps

A manually operated fire pump need not be self-priming. However, if the manually operated fire pump will not self-prime from a dry suction, it shall be constructed so that it can be quickly and effectively primed.

4.7.4 Emergency fire pump

4.7.4.1 Application

An emergency fire pump or fire buckets shall be provided in accordance with Table 21 on vessels of *Fire Risk Category II* where a fire in a *High Fire Risk Space* could render the main fire pump inoperative.

NOTE: For *Fire Risk Category III* and *IV* vessels, the two main fire pumps are arranged so that one is capable of acting as the emergency pump for the other.

Table 21 — Emergency fire pump on vessels of *Fire Risk Category II*

Measured length x breadth m ²	Source of power for emergency fire pump	Minimum emergency fire pump capacity per fire hose appliance m ³ /hr
< 100	Not required	2 fire buckets in lieu
≥ 100 and < 1900	Manual (A) or Power	5.5
≥ 1900 and < 3400	Power	7.5
≥ 3400	Power	12.0

KEY:

(A) Manually operated emergency fire pumps shall comply with Clause 4.7.3.11.

4.7.4.2 Type

The emergency fire pump shall be independently driven. The pump may be of fixed or portable type. Where permitted in Table 21, the emergency fire pump may be manually operated provided—

- a) the vessel does not have a *Ro-Ro space* or *helideck* and does not carry *dangerous goods*; and

- b) the water jet from the fire hose appliance achieves a throw of not less than 6 m when supplied with water from the emergency fire pump at the most hydraulically disadvantaged location.

4.7.4.3 Priming of emergency fire pumps

An emergency fire pump need not be self-priming. However, if the emergency fire pump will not self-prime from a dry suction, it shall be constructed so that it can be quickly and effectively primed.

4.7.4.4 Period of operation

The emergency fire pump and its source of power shall be capable of continuous operation for a period not less than that specified for continuous operation of emergency electrical installations under NSCV Part C Subsection 5B.

4.7.4.5 Location

The location of the emergency fire pump and ancillary items associated with the pump, e.g. sea suctions, sources of power and fuel tanks, shall be in a place remote from the *High Fire Risk Space* containing the main fire pump.

Access to the emergency fire pump shall not be via the space containing the main fire pump.

4.7.4.6 Emergency fire pump suction

The sea suction of emergency fire pumps shall comply with Clause 4.7.3.8. Where a portable suction hose is used, the hose shall be—

- a) of length necessary to maintain immersion under all conditions of loading and trim of the vessel, and under weather conditions liable to be encountered in service;
- b) weighted to maintain immersion;
- c) provided with fittings sufficiently robust to withstand the rigours of emergency usage;
- d) provided with a foot valve; and
- e) constructed so that it will not collapse under the effect of the pump suction.

4.7.5 Fire main and hydrants for fire hose appliances

4.7.5.1 Dedicated purpose

The fire main for fire hose appliances shall not be used for supplying water for any purpose other than extinguishing fire or testing fire hose appliances. The fire main shall have no connections other than those necessary for fire-fighting and washing decks.

NOTE: The above clause does not preclude the use of fire hose appliances for washing down anchors or decks on the basis that such activities serve as a periodic practical test of these appliances. However, procedures should be adopted that maintain the readiness of the fire hose appliances during and after such activities.

4.7.5.2 Materials

Materials readily rendered ineffective by heat shall not be used for the fire main piping and hydrants unless protected or otherwise isolated to prevent failure of water supply for a period of not less than that specified—

- a) for the *time rating* of *High Fire Risk* machinery spaces under Table 7 to Table 9, as applicable, assuming the fire main is dry; and
- b) in Clause 4.7.3.5, assuming the fire main is filled with water.

4.7.5.3 Hydrant arrangement

Hydrants shall be arranged as follows:

- a) Where two water jets are specified in Table 19, the water jets from two fire hoses from two different hydrants shall reach any location on the vessel normally accessible to persons, one of the jets being from a single length of hose and the other from no more than two lengths of hose.
- b) Where a single water jet is specified in Table 19, the water jet from a hydrant using a single length of hose shall reach any location on the vessel normally accessible to persons.

The assumed length of hose for the purposes of this Clause shall not exceed the maximum length specified in Clause 4.7.6.2.1.

NOTE: Additional requirements for the arrangement of hydrants are specified in Clause 6.5.8 for *Ro-Ro spaces*, Clause 6.6.4 for spaces containing *dangerous goods* and Clause 6.7.6 for *helidecks*.

4.7.5.4 Hydrant accessibility

Hydrants shall be placed so that the fire hoses may be easily and quickly coupled to them. Where deck cargo or vehicles may be carried—

- a) the positions of the hydrants shall be such that they are always readily accessible; and
- b) the fire main shall be arranged to avoid damage by the deck cargo or vehicles.

4.7.5.5 Valves and fittings at hydrants

A valve shall be fitted to each fire hydrant so that the fire hose may be readily removed while the fire pump is in operation. Fire hydrants shall have the same end fitting so that hoses can be interchanged or used at all different hydrants on the vessel. Fire hydrant valves and fire main isolating valves shall not be one-way (non-return) valves.

4.7.5.6 Maximum permissible pressure

The maximum pressure at any hydrant shall not exceed that at which the effective control of a fire hose can be demonstrated.

NOTE: AS 2419 specifies a maximum pressure of 500 kPa for fire hoses 65 mm in diameter.

4.7.5.7 Prevention of over-pressure

Relief valves shall be incorporated in the fire main to prevent excessive pressure in any part of the system. This Clause does not apply if the fire

pumps are incapable of developing a pressure exceeding the design pressure of the piping, hydrants and hoses.

4.7.5.8 **Isolating valves**

On vessels fitted with more than one fire pump (main or emergency) connected to the fire main, those portions of the fire main that pass through a machinery space of *High Fire Risk Space* containing a fire pump shall be capable of being isolated from the rest of the piping by a valve external to the machinery space. The piping shall be so arranged that when the isolating valves are shut, all the hydrants on the vessel, except those in the machinery space referred to above, can be supplied with water by the other main fire pump or the emergency fire pump. All isolating valves in the piping shall be clearly marked.

4.7.5.9 **International shore connection**

The fire main on all vessels of 35 m or more in measured length shall be provided with at least one international shore connection complying with Figure 5. The shore connection facility shall be arranged to enable ready connection from either side of the vessel.

NOTE: The fitting may be of a portable type stowed in a location ready to use in time of emergency.

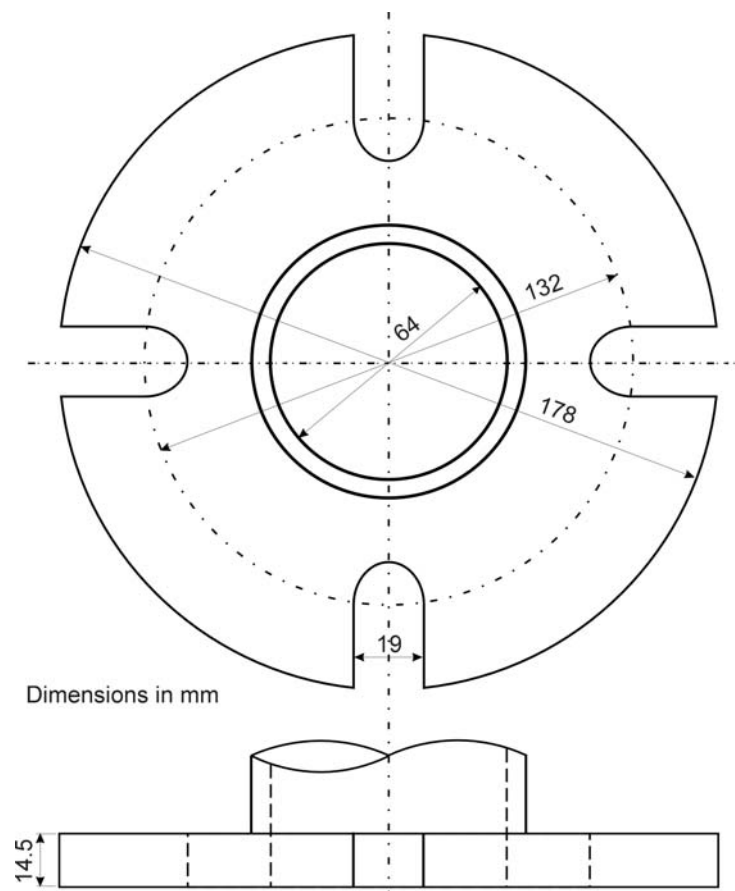

Figure 5 — International shore connection

4.7.6 Fire hoses and nozzles

4.7.6.1 General

The following items shall be kept ready for use and located in a conspicuous position near each hydrant:

- a) A fire hose that conforms with Clause 4.7.6.2.
- b) A nozzle that conforms with Clause 4.7.6.3.
- c) Any necessary fittings and tools.

Fire hoses and nozzles in interior locations should be arranged to enable them to remain connected to the hydrants at all times.

NOTE: See Clause 4.7.5.3 for the location of hydrants.

4.7.6.2 Fire hoses

4.7.6.2.1 Length

Fire hoses shall have a length of at least 10 m, but not more than—

- a) 15 m in machinery spaces;
- b) 20 m in other spaces and open decks; and
- c) 25 m for open decks on vessels with a maximum breadth in excess of 30 m.

4.7.6.2.2 Minimum diameter

The internal diameter of fire hoses shall not be less than—

- a) 19 mm for reinforced elastomeric fire hose; or
- b) 38 mm for lay-flat fire hose.

4.7.6.2.3 Specification

Lay-flat fire hoses shall comply with Chapter 12.

4.7.6.3 Nozzles

4.7.6.3.1 Nozzle size

Single orifice nozzles shall have an orifice diameter not less than that specified in Table 17. Other types of nozzles shall have a minimum flow rate not less than the minimum flow rate specified in Table 17.

NOTE: Some appliances such as dual-purpose nozzles or *foam making branch pipes* may require a specified minimum pressure higher than that assumed in the table to operate correctly.

4.7.6.3.2 Nozzle type

Nozzles having a flow rate of 6.5 m³/hr or more shall be of dual-purpose type (i.e. spray / jet) incorporating a shutoff. The nozzle shall be suited to the application, taking into account the design pressure at the hydrant and the corrosive effects of long-term stowage in a maritime environment (i.e. robust, corrosion resistant).

4.8 FIRE BUCKETS

4.8.1 Application

Fire buckets shall be provided on a vessel that—

- a) is not required to be fitted with fire hose appliances under Clause 4.7.1; or
- b) is required to have fire buckets in lieu of an emergency fire pump under Clause 4.7.4.1.

4.8.2 Number of fire buckets

Where fire buckets are required on a vessel of *Fire Risk Category I* or *II* under Clause 4.8.1, the number of fire buckets shall be as specified in Table 22.

Table 22 — Fire buckets on vessels of *Fire Risk Category I* or *II*

Measured length of vessel	Number of fire buckets
< 10 m	1 (A)
≥ 10 m	2

KEY:

- (A) A fire bucket need not be provided on *Fire Risk Category I* or *II* vessels not having *High Fire Risk* or *Moderate Fire Risk* spaces or enclosed *Accommodation Spaces*.

4.8.3 Standard

A fire bucket shall be—

- a) of minimum 4 L capacity;
- b) fitted with a handle;
- c) manufactured from waterproof and robust material;
- d) designed so as not to collapse, distort or lose the handle when full of water; and
- e) fitted with a lanyard of sufficient length to allow the bucket to be cast over the side and retrieved full of water.

4.9 FIXED FIRE-EXTINGUISHING SYSTEMS

4.9.1 Application

Fixed fire-extinguishing systems shall be provided on vessels to the extent specified in Chapter 6, Chapter 7, Chapter 8 or Chapter 9. A list of the relevant clauses is listed in Table 23.

NOTE: Not all vessels need be fitted with a *fixed fire-extinguishing system*, refer to the relevant clauses within this Section.

Table 23 — Clauses for determining a requirement to fit *fixed fire-extinguishing systems*

Location	Clause
High fire risk machinery spaces	6.4.13
Ro-Ro spaces	6.5
Cargo spaces containing dangerous goods	6.6.5
Store spaces containing flammable liquid	6.8.7
Vessel's stores lockers	6.9.5.3
Galleys	7.5.8
Accommodation spaces	8.20
Cargo spaces	9.4.6

4.9.2 System to be suited to application

A *fixed fire-extinguishing system* fitted to protect a space or an item of equipment shall be suited to—

- a) the likely types of fire hazards within the space or associated with the item of equipment;
- b) the characteristics of the space including the dimensions of the space, movement of air within the space and whether the space can be effectively sealed; and
- c) special risks associated with the space or item of equipment such as the presence of—
 - i) essential equipment;
 - ii) electrical equipment; or
 - iii) persons that might be within the space including—
 - A) persons that could be exposed to an accidental discharge; and
 - B) fire-fighting personnel.

EXAMPLE:

A local fire-extinguishing system that is fitted to protect a galley range or deep-fat cooker is typically a wet chemical type.

4.9.3 Standards for fixed fire-extinguishing systems

The *fixed fire-extinguishing system* shall be designed, manufactured, installed and tested in accordance with the requirements of Chapter 12.

NOTE: The relevant standard contains provisions for determining the quantity of extinguishing agent, arrangements for discharge, and the means for protecting personnel from accidental discharge.

4.9.4 Closing appliances for fixed gas, water mist or aerosol fire-extinguishing systems

Where a fixed gas, water mist or aerosol fire-extinguishing system is used, openings that may admit air to, or allow gas, aerosol or mist to escape from, a protected space shall be capable of being effectively sealed from outside the protected space.

NOTE: Other clauses within this Section may also require that a space be effectively sealed, see Clauses 3.8, 4.2 and 4.3. The closing down of a space also serves to suppress a fire by starving it of oxygen, independent of the presence or type of extinguishing system.

4.9.5 Protection of components of the fixed fire-extinguishing system

Components of a *fixed fire-extinguishing system*, including pumps and storage containers, shall be located—

- a) in a space behind the collision bulkhead; and
- b) outside the space protected by the *fixed fire-extinguishing system*; to the extent necessary to isolate any components of the system that would be vulnerable to exposure to a fire within the protected space.

For the purposes of the application of Table 7, Table 8 and Table 9 to any bulkheads and decks adjacent to the space protected, the space containing components of a *fixed fire-extinguishing system* located outside the space protected by the system shall be designated a '*Control Station*'.

4.9.6 Storage of gaseous fire-extinguishing agent

Where containers for gaseous extinguishing agent are located outside the protected space, the room for storage of these containers shall:

- a) not be used for any other purpose;
- b) be situated in a safe and readily accessible position;
- c) be effectively ventilated;
- d) have an entrance from the open deck that is independent from spaces that are protected by the system;
- e) have access doors that open inwards; and
- f) have gastight boundaries (bulkheads and decks).

Carbon dioxide storage shall be located at deck level to minimise the risks to persons in the event of leakage.

4.9.7 Evacuation Alarms

An automatic audible and visual warning shall be given of the impending release of fire-extinguishing agent into any space in which personnel normally work, or to which they have access. The alarm permits the orderly evacuation of the space and provides time to shut down machinery and seal the space. The alarm shall operate for a suitable period before the agent is released, but not less than 20 seconds. The evacuation alarm shall be separate and distinct from any fire alarm, including a different sound, separate warning lights and wiring.

The time delay before release of agent shall be either engineered into the system or achieved by delaying the manual operation of the release in accordance with appropriate instructions posted adjacent to the release mechanism, see also Clause 4.9.10.

4.9.8 Limitations on automatic activation

Fixed fire-extinguishing systems shall be provided with a means of manual activation. Automatic release of fire-extinguishing media shall not occur, except for—

- a) aqueous fixed fire-extinguishing systems in Accommodation Spaces (see Clause 8.20);
- b) pressure water-spraying systems in *Ro-Ro spaces* (see Clause 6.5.7); or
- c) local-fire extinguishing systems in certain applications (see Clause 7.5.8).

NOTE: Water-mist systems in *Ro-Ro spaces* may require the space to be sealed before discharge of the fire-extinguishing agent.

4.9.9 Controls

Controls for the *fixed fire-extinguishing system* shall be readily accessible and simple to operate. Controls shall be grouped together in as few locations as possible at positions not likely to be cut off by a fire in the protected space.

4.9.10 Instructions

At each control location there shall be clear instructions on the use and operation of the *fixed fire-extinguishing system*. The instructions shall include all prerequisite tasks and possible effects on the safety of personnel. Where appropriate, a warning should be displayed highlighting potential risks of premature release or re-entry such as toxicity, asphyxiation and/or reduced visibility.

4.9.11 Systems that serve more than one space

Where the extinguishing agent is required to protect more than one space, the quantity of agent available need not be more than the largest quantity required for protecting any one space.

4.9.12 Over-pressure or under-pressure in space protected

If the release of a fire-extinguishing agent produces significant over- or under-pressurisation in the protected space, means shall be provided to limit the induced pressures to acceptable limits to avoid structural damage.

4.10 PORTABLE AND WHEELED FIRE EXTINGUISHERS

4.10.1 Application

Vessels shall be provided with portable fire extinguishers as specified in Chapter 6 to Chapter 10 of this Section.

Table 24 — Extinguishing media for given hazards

Nature of hazard	Fire class or capability rating of extinguisher	Suitable extinguishing media (in order of effectiveness)
Clothing fire—a fire in the clothes being worn by a person	A	Water Fire blanket
Small cellulose solids fire, plastics	A	Water Foam ABE powder (2) Wet chemical Vaporising liquid
Large cellulose solids fire, plastics	A	Water ABE powder (2)
Petroleum-based liquid	B	BE and ABE powder (2) Foam Vaporising liquid
Polar solvents	B	BE and ABE powder (2) Alcohol-resistant foam
Gas fires (5)	C	BE and ABE powder (2) Vaporising liquid
Metal fires	D	Special powder (2)
Energised electrical equipment of greater than 50 V (4) (6)	E	BE and ABE powder Carbon dioxide (1) Vaporising liquid
Cooking oils and fats (3)	F	Wet chemical BE powder (2) Fire blanket

KEY:

- (1) Carbon dioxide, used in sufficient concentration to extinguish a fire, will displace air. In a confined space, oxygen deficiency is life threatening.
- (2) Powder extinguishers, discharged in a confined space, can temporarily reduce visibility and may cause respiratory irritation.
- (3) ABE powders based on ammonium phosphate are not suited for the protection of appliances using cooking oils or fats.
- (4) Water-based extinguishers (water, wet chemical and foam) are electrically conductive and therefore are not suitable for fires involving electrically energised equipment.
- (5) Applicable to vessels carrying gas as *dangerous goods* cargoes or tanks for propulsion machinery propelled by gas fuel. Not required for conventional domestic gas installations on vessels.
- (6) An agent leaving minimal residue should be used in spaces containing electrical equipment essential to the safety of the vessel.

Even though no portable extinguishers may be specified in Chapter 6 to Chapter 10, the following vessels shall be provided with at least one portable fire extinguisher:

- a) Any mechanically powered vessel;
- b) Any non-mechanically powered vessel that has—
 - i) open flame devices, (e.g. cooking appliances and heaters, including those on an open deck); or
 - ii) deck mounted internal combustion machinery, enclosed petrol tanks or other potential sources of fire such as incinerators or boilers.

Wheeled fire extinguishers shall be provided on vessels for which Clauses 6.4.15 or 6.7.8 apply.

4.10.2 Type

4.10.2.1 *Extinguishers to be suited to hazard*

Portable and wheeled fire extinguishers shall be suited to the type of fire likely within the space to be protected and shall comply with Table 24 and Chapter 12.

Portable and wheeled fire extinguishers shall be fitted with a hose to enable access to awkward locations and facilitate the effective application of the extinguishing agent.

NOTE: On small vessels carrying a limited number of fire extinguishers that must be used for a range of hazards including electrical hazards, a combination of BE powder, ABE powder or carbon dioxide extinguishers provide the best compromise.

4.10.2.2 *Extinguishers for spaces containing essential equipment*

Portable fire extinguishers for spaces containing electrical or electronic equipment or appliances essential for the safety of the vessel (such as *Control Stations*) shall use an extinguishing agent that is not harmful to the equipment and appliances.

4.10.2.3 *Extinguishers for spaces containing electrical equipment*

Portable and wheeled fire extinguishers for spaces containing electrical equipment shall use an extinguishing agent that is not electrically conductive.

4.10.3 Number of portable fire extinguishers

The total number of portable fire extinguishers provided on a vessel shall be the sum of the number specified for individual spaces by the clauses listed in Table 25.

Where no extinguishers are specified in these clauses at least one may be required—see Clause 4.10.1.

Table 25 — Clauses for determining number of portable fire extinguishers

Location	Clause
High fire risk machinery spaces	6.4.14, 6.4.15, 6.4.16
Ro-Ro spaces	6.5.9
Cargo spaces containing dangerous goods	6.6.5
Helicopter facilities	6.7.8
Vessel's stores lockers	6.9.5.3
Spaces of moderate fire risk	7.3.3
Moderate fire risk machinery spaces	7.4.3
Galleys	7.5.7
Accommodation spaces	8.19
Control stations	10.9

4.10.4 Size and rating

The minimum size and rating (the latter in accordance with AS/NZS 1850) of portable fire extinguishers shall not be less than specified in Table 26. Where a single extinguisher is used for multiple classes of fire, the extinguisher shall be of a size and rating to satisfy the minimum requirements of each of the relevant classes of fire.

4.10.5 Location

Fire extinguishers shall be situated ready for use at easily visible places so they can be reached quickly and easily in the event of a fire. They shall be mounted so that their serviceability is not impaired by the weather, vibration or other external factors.

One of the portable fire extinguishers intended for use in a *High Fire Risk Space* or *Moderate Fire Risk Space* shall be stowed near the entrance to that space. Where a high or *Moderate Fire Risk Space* is unlikely to be manned, the portable extinguisher stowed near the entrance to that space shall be mounted externally and adjacent to the entrance of the space.

4.10.6 Marking

If an extinguisher is stowed within a locker or other enclosed space, the door to the locker or enclosed space shall carry a symbol or notice that gives a clear indication that the space contains a portable extinguisher.

4.10.7 Indication of previous use

Portable and wheeled fire extinguishers shall be provided with devices that indicate whether they have been used.

NOTE: The loss of the extinguisher taper seal is considered sufficient indication of use.

Table 26 — Minimum size and rating of portable fire extinguishers

Fire Class	Risk criterion	Extinguisher Characteristic	Type of portable extinguisher				
			Water	Foam	Dry Powder	Wet Chemical	CO2
Class A	Vessel ≥ 10 m	Min. size (1)	9 L	9 L	4.5 kg	7 L	NDTS
		Min. rating (6)	3A	3A	3A	3A	NDTS
	Vessel < 10 m	Min. size (1)	4.5 L	4.5 L	2 kg	7 L	NDTS
		Min. rating (6)	2A	2A	2A	2A	NDTS
Class B	Machinery (5) ≥ 750 kW	Min. size (1)	NDTS	2 x 9 L (3)	4.5 kg	NDTS	NDTS
		Min. rating (6)	NDTS	30B ea	60B	NDTS	NDTS
	Machinery (5) ≥ 25 kW & < 750 kW, Ro-Ro spaces, helidecks	Min. size (1)	NDTS	9 L	4.5 kg	NDTS	NDTS
		Min. rating (6)	NDTS	20B	20B	NDTS	NDTS
	Machinery (5) < 25 kW	Min. size (1)	NDTS	4.5 L	2 kg	NDTS	5 kg
		Min. rating (6)	NDTS	10B	10B	NDTS	10B
Class E	Electrical system ≥ 25 kW electrical power	Min. size (1)	NDTS	NDTS	4.5 kg	NDTS	5 kg
		Min. rating (6)	NDTS	NDTS	E	NDTS	E
	Electrical system < 25 kW electrical power	Min. size (1)	NDTS	NDTS	2 kg	NDTS	3 kg
		Min. rating (6)	NDTS	NDTS	E	NDTS	E
Class F	Large galleys	Min. size (1)	NDTS	NDTS	4.5 kg	3.5 L	NDTS
		Min. rating (6)	NDTS	NDTS	30B (4)	4F	NDTS
	Small galleys (2)	Min. size (1)	NDTS	NDTS	2 kg	2 L	NDTS
		Min. rating (6)	NDTS	NDTS	2F (4)	2F	NDTS

KEY:

- (1) While some fire extinguishers of lesser size may achieve the required fire rating, a minimum size has been specified to allow for conditions of use and the possible inexperience of the user.
- (2) For fire extinguishers for *small galleys*, refer to Clause 7.5.7.
- (3) Two 9 L 30B foam extinguishers may be substituted for one 4.5 kg 60B dry powder extinguisher.
- (4) To be BE type dry powder.
- (5) Machinery includes internal combustion machinery, steam boilers using oil fuel, pumps and other equipment for pumping or processing *flammable* or *combustible liquids*, or containing lubricating or hydraulic oil.
- (6) The rating shall be in accordance with AS 1850.

NDTS: denotes 'not deemed-to-satisfy' the requirements of this Standard.

NOTES:

1. An extinguisher matching the exact combination of minimum size and minimum rating listed in the table may not be commercially available, in which case a larger size or higher rating may have to be used.
2. There are benefits associated with carrying a combination of both dry powder and foam extinguishers for Class B fires. Dry powder extinguishers are suited to fires originating from liquids under pressure or on non-horizontal surfaces, foam extinguishers are more suited to fires in bilge spaces and to prevent re-flash.

4.10.8 Replenishment in the event of use

Vessels in Class A service shall have provision to replenish discharged portable extinguishers at sea. Replenishment may be by replacement of discharged extinguishers with extinguishers of the same quantity, type and capacity, or by recharging discharged extinguishers.

Replacement extinguishers or spare charges shall be provided for the first 10 and half of the remaining extinguishers. Not more than 60 spare extinguishers and charges are required. Where replenishment is by recharging, instructions for recharging shall be carried on board.

NOTE: For the obligations of crew that undertake the recharging of portable fire extinguishers, refer to Part E—Operational practices.

4.11 FIRE-FIGHTERS' OUTFITS

4.11.1 Applicable standard

Fire-fighters' outfits shall comply with Chapter 12.

4.11.2 Number of fire-fighters' outfits

Fire-fighters' outfits shall be provided on seagoing (Class A, B, C) vessels in accordance with Table 27.

Table 27 — Fire-fighters' outfits for sea-going vessels

Category	Class A, B and C vessels	
	Minimum number of outfits	Minimum number of spare charges
<i>Fire Risk Category I</i>	Not required	Not required
<i>Fire Risk Category II</i>	Not required	Not required
<i>Fire Risk Category III</i>	Not required	Not required
<i>Fire Risk Category IV</i>	4 (A)	2

KEY:

(A) Two sets are for the use of a rescue or fire-fighting party. The other two are available for a backup team should the rescue or fire-fighting party get into difficulties.

NOTE: It is assumed that vessels operating in sheltered waters will have reasonable access to shore-based fire-fighting personnel, see Part A of this standard for guidance on safety obligations and Part E for emergency preparedness.

4.11.3 Storage of fire-fighters' outfits

Each set of fire-fighters' outfits and spare charges shall be kept—

- a) ready for use;
- b) in an easily accessible location that is permanently and clearly marked; and
- c) in widely separated positions from other sets.

CHAPTER 5 FIRE SAFETY PREPAREDNESS

5.1 APPLICATION

Where specified in Table 28, a vessel shall be provided with a fire control plan, a fire training manual, and a fire safety operational booklet.

NOTES:

1. The fire control plan, fire training manual and fire safety operational booklet provide vital information needed for an operator to comply with NSCV Part E—Operating Practices.
2. Notwithstanding the requirements of this standard, a vessel may be obliged to carry information pertaining to fire safety to comply with OH&S and other legislation.

Table 28 — Fire control plan, fire training manual and fire safety operational booklet

Category	Application
<i>Fire Risk Category I</i>	Required if measured length \geq 25 m (1)
<i>Fire Risk Category II</i>	Required if measured length \geq 25 m (1)
<i>Fire Risk Category III</i>	Required for all vessels
<i>Fire Risk Category IV</i>	Required for all vessels

KEY:

- (1) Vessels of any length that carry *dangerous goods* in cargo spaces of the type described in Clause 6.6 shall be provided with a fire control plan, fire training manual and fire safety operational booklet.

5.2 OBJECTIVE

The objective of this Chapter is to ensure that information relevant to the effective and safe operation of *fire equipment* on a vessel is readily available to persons on the vessel for emergency planning and training; maintenance; and ready reference in the event of a fire.

5.3 FIRE CONTROL PLAN

5.3.1 Content of the fire control plan

The fire control plan shall show clearly³ for each deck the following positions as applicable—

- a) *Control Stations*;
- b) sections of the craft which are enclosed by *fire-resisting divisions*;
- c) smoke zones;
- d) evacuation alarms;
- e) *fixed fire detection and fire alarm systems*;
- f) *fixed fire-extinguishing systems*;

³ Refer to ISO 17631:2002 CE Ships and marine technology CE Shipboard plans for fire protection, life-saving appliances and means of escape.

- g) *fire appliances*;
- h) personal protective equipment including fire-fighters' outfits and emergency escape breathing devices;
- i) the means of access to the various compartments and decks in the vessel;
- j) the ventilating system (including particulars of the master fan controls, the positions of *fire flaps*, smoke flaps and *fire dampers* and identification numbers of the ventilating fans serving each section of the vessel);
- k) the location of the international shore connection, if fitted; and
- l) the position of all means to control the fuel shut-off valves, ventilation fan shutdown, *fixed fire detection and fire alarm systems* and *fixed fire-extinguishing systems*.

5.3.2 Location

The vessel shall have a fire control plan permanently exhibited in a location suitable for ready reference by the crew.

5.3.3 Duplicate set of fire control plans

Vessels of measured length 35 m or more shall have a duplicate set of fire control plans or a booklet containing such plans permanently stored in a prominently marked weathertight enclosure outside the deckhouse for the assistance of shore-side fire-fighting personnel⁴.

5.4 TRAINING MANUAL

5.4.1 Content

The training manual shall explain the following in detail, using easily understood terms and illustrated wherever possible:

- a) General fire safety practice and precautions related to the dangers of smoking, electrical hazards, *flammable liquids*, *dangerous goods* and similar common shipboard hazards.
- b) General instructions on fire-fighting activities and fire-fighting procedures including procedures for notification of a fire and use of manually operated call points.
- c) Meanings of the vessel's alarms.
- d) Operation and use of *fire equipment*.
- e) Operation and use of fire doors.
- f) Operation and use of ventilation shutdowns, *fire flaps*, smoke flaps and *fire dampers*.
- g) Escape systems and appliances.

⁴ Refer to the Guidance concerning the location of fire control plans for assistance of shore-side fire-fighting personnel (MSC/Circ.451).

5.4.2 Location

A training manual shall be located in each crew mess room or in each crew cabin.

5.5 FIRE SAFETY OPERATIONAL BOOKLET**5.5.1 Content**

The fire safety operational booklet shall contain the necessary information and instructions for the safe operation of the vessel and cargo handling operations with respect to fire safety. The booklet shall include information concerning:

- a) The crew's responsibilities for the general fire safety of the vessel while loading and discharging cargo and while underway.
- b) An explanation of necessary fire safety precautions for handling general cargoes.
- c) For vessels carrying *dangerous goods*, relevant stowage and segregation information for the *dangerous goods* to be carried.
- d) For vessels carrying *dangerous goods*, the applicable references to the pertinent fire-fighting and emergency cargo handling instructions contained in—
 - i) the Code of Safe Practice for Solid Bulk Cargoes; and
 - ii) the International Maritime Dangerous Goods Code, as appropriate.

The fire safety operational booklet may be combined with the training manual.

5.5.2 Location

A fire safety operational booklet shall be located in each crew mess room or in each crew cabin.

CHAPTER 6 HIGH FIRE RISK SPACES

6.1 SCOPE

This Chapter lists requirements from Chapter 3 and Chapter 4 that are applicable to *High Fire Risk Spaces* and specifies particular requirements that are additional to or modify the general requirements in Chapter 3 and Chapter 4.

6.2 APPLICATION

This Chapter applies to spaces defined by Clause 1.8 as High Fire Risk Spaces. Specific clauses within this Chapter that apply are listed in Table 29.

Table 29 — Application of Chapter 6

Clause	Subject
Clause 6.3	General requirements applicable to High Fire Risk Spaces
Clause 6.4	Machinery spaces of high fire risk
Clause 6.5	Ro-Ro spaces
Clause 6.6	Cargo spaces containing dangerous goods
Clause 6.7	Helidecks
Clause 6.8	Store spaces containing packaged flammable or combustible liquids
Clause 6.9	Flammable and combustible vessel's stores

6.3 GENERAL REQUIREMENTS APPLICABLE TO HIGH FIRE RISK SPACES

6.3.1 General

High Fire Risk Spaces shall comply with the clauses in Chapter 3 and Chapter 4 specified in Table 30.

**Table 30 — General deemed-to-satisfy provisions applicable to
High Fire Risk Spaces**

Clause	Subject
Clause 3.2	Storage of combustible or flammable oils
Clause 3.3	Engine exhausts, boiler and galley uptakes
Clause 3.4	Certain highly flammable materials prohibited
Clause 3.5	Insulation
Clause 3.6	Paints, varnishes & other finishes on passenger vessels
Clause 3.7	Structural fire protection
Clause 3.7.4	Combustible veneers
Clause 3.9	Maintenance of structural integrity
Clause 3.10	Materials for overboard fittings
Clause 4.2	Remote stops for ventilation and exhaust fans
Clause 4.3	Ventilation closing appliances
Clause 4.4	Centralised fire control functions on passenger vessels
Clause 4.5	Fire detection and fire alarm system
Clause 4.6	Emergency escape breathing devices
Clause 4.7.3	Main fire pumps
Clause 4.7.4	Emergency fire pump
Clause 4.7.5	Fire main and hydrants for fire hose appliances
Clause 4.7.6	Fire hoses and nozzles
Clause 4.9	Fixed
Clause 4.10	Portable and wheeled fire extinguishers

PREVENTION OF FIRE AND EXPLOSION

6.3.2 Signage to prevent inadvertent ignition

“No smoking” or “No naked light” notices shall be displayed in a prominent position at points of entry into and, where appropriate, within *High Fire Risk Spaces*.

FIRE GROWTH POTENTIAL

6.3.3 Primary deck materials and coverings

Primary deck materials, floor plates, floor plate supporting structures and deck coverings within *High Fire Risk Spaces* shall—

- a) be of non-combustible material unless, in the case of deck materials or floor plate supporting structures, they form part of the primary hull structure of a vessel constructed of *combustible materials*; and

- b) not absorb oil or other *combustible* or *flammable liquids*.

6.4 MACHINERY SPACES OF HIGH FIRE RISK

PREVENTION OF FIRE AND EXPLOSION

6.4.1 Fuel and lubricating oil tanks

6.4.1.1 Location

The following fuel tanks shall not be situated within machinery spaces of *High Fire Risk*:

- a) Fuel tanks not complying with Clause 6.4.1.2.
- b) Fuel tanks containing fuel of flashpoint less than 60°C.

Fuel and lubricating oil tanks shall be located to ensure that any spillage or leakage cannot constitute a fire or explosion hazard by falling on heated surfaces.

6.4.1.2 Fire-resistance of tanks

Fuel tanks situated within a machinery space of *High Fire Risk* shall be constructed of a material, or suitably insulated, so that when exposed to the standard fire test given in Chapter 12, the tank remains structurally intact. The time period for exposure to the standard fire test shall be no less than the *time rating* of the *fire-resisting division* required for the machinery space specified in Table 7, Table 8 or Table 9.

6.4.1.3 Freestanding fuel tanks

Freestanding fuel tanks shall not be fitted in machinery spaces of *High Fire Risk* on vessels of *Fire Risk Category III* or *IV*.

Where freestanding fuel tanks are fitted in machinery spaces of *High Fire Risk* on vessels of *Fire Risk Category I* or *II*, they shall be placed in an oil-tight spill tray designed to catch any fuel that may leak from the tank when the vessel is rolling, to a quantity not less than 5 per cent of volume of the freestanding tank. The spill tray shall—

- a) be of sufficient dimensions to retain the required volume of oil when subject to normal motions when the vessel is operating; or
- b) be provided with a drainpipe leading to a spill oil tank of the required volume.

The spill tray and spill oil tank, if fitted, shall be provided with means to enable safe removal of accumulated oil.

NOTE: Additional requirements for fuel tanks are given in NSCV Part C Subsection 5A.

6.4.2 Fuel piping

Fuel piping shall not be located immediately above or near units of high temperature including boilers, steam pipelines, exhaust manifolds, turbochargers or silencers. As far as practicable, fuel piping shall be located away from hot surfaces, electrical installations or other sources of ignition. Fuel piping shall be screened or otherwise suitably protected to avoid oil spray or oil leakage onto possible sources of ignition.

The number of joints in fuel oil piping systems shall be kept to the necessary minimum.

6.4.3 Provision for inspection

To facilitate the early observation of defects and leakage, components of an *oil fuel unit* containing heated oil under pressure exceeding 180 kPa shall not be placed in a concealed position. Such components within a machinery space shall be adequately illuminated.

6.4.4 Containment of spillage

Precautions shall be taken to prevent any oil that may escape under pressure from any pump, filter or heater from coming into contact with heated surfaces.

6.4.5 Insulation

Surfaces with temperatures above 220°C that may come into contact with fuel because of a fuel system failure shall be effectively protected to prevent ignition, see also Clause 3.5.

6.4.6 Jacketing of high-pressure fuel delivery lines

For vessels of *Fire Risk Category* III or IV, external high-pressure fuel delivery lines between the high-pressure fuel pumps and fuel injectors shall be protected with a jacketed piping system capable of containing fuel from a high-pressure line failure. The jacketed piping system shall include a means for collecting leaked fuel. An alarm shall be provided to indicate a fuel line failure.

NOTES:

1. A jacketed pipe incorporates an outer pipe into which the high-pressure fuel pipe is placed, forming a permanent assembly.
2. Jacketing may also apply to machinery on vessels of *Fire Risk Category* I or II if required by relevant Classification Society rules for vessels 35 m or more in length, see Part C Subsection 5A.

6.4.7 Prevention of accumulated oil vapours

The ventilation of machinery spaces shall be sufficient under normal conditions to prevent accumulation of oil vapour.

FIRE GROWTH POTENTIAL

6.4.8 Separation from other spaces

Machinery spaces of *High Fire Risk* shall be separated from other spaces on the vessel by gas-tight bulkheads or enclosures to enable the space to be sealed in the event of a fire.

6.4.9 Control of ventilation in machinery spaces

6.4.9.1 Number of openings

The number of skylights, doors, ventilators, openings in funnels for exhaust ventilation, and other openings to machinery spaces shall be

reduced to a minimum consistent with the needs of ventilation and the proper and safe working of the vessel.

6.4.9.2 Means of controlling openings and ventilation

The means provided for stopping the power ventilation of the machinery spaces in Clause 4.2 shall be entirely separate from the means provided for stopping ventilation of other spaces.

6.4.9.3 Release of smoke from machinery spaces

Means shall be provided to permit the release of smoke after a fire in the machinery space. Controls shall be located outside the space concerned so that, in the event of fire, they will not be cut off from the space they serve.

NOTE: The normal ventilation system may be acceptable for this purpose provided the *fire flaps* are arranged for reopening after closure.

MEANS OF ESCAPE

6.4.10 Protected escape from machinery spaces of High Fire Risk

Machinery spaces below the *weather deck* on vessels of 45 m measured length or more shall be fitted with one of the following:

- a) Two sets of steel ladders as widely separated as possible, leading to similarly separated doors in the upper part of the space. Each of the doors shall provide access to an appropriate survival craft embarkation location. One of these ladders shall be located within a protected enclosure from the lower part of the space it serves to a safe position outside the space. The enclosure shall satisfy the fire protection requirements of Clause 3.7. Self-closing fire doors of the same fire integrity standards shall be fitted in the lower end of the enclosure. The ladder shall be fixed in such a way that heat is not transferred into the enclosure through non-insulated fixing points. The protected enclosure shall have minimum internal dimensions of 800 mm x 800 mm, and shall be provided with emergency lighting.
- b) One steel ladder leading to a door in the upper part of the space from which access is provided to the embarkation deck and a separate door in the lower part of the space well separated from the ladder. This lower door shall be of fire-resisting construction, capable of being operated from each side, and shall provide access to a safe escape route from the lower part of the space to the embarkation deck.

CONTAINMENT OF FIRE

6.4.11 Fire integrity between machinery spaces of High Fire Risk and adjacent spaces

For certain Class 2 and Class 3 vessels of *Fire Risk Category 1*, the requirements for *fire-resisting divisions* in machinery spaces of *High Fire Risk* specified in Table 7 may be modified in accordance with Table 31.

Table 31 — Variations to the requirements for machinery space *fire-resisting divisions* specified in Table 7 (*Fire Risk Category I*)

Category		Application
Class 2 or 3 without accommodation for berthed persons	Seagoing < 12.5 m length	<i>Smoke-tight</i> in lieu of <i>fire-resisting division</i> (1)
	Sheltered waters < 25 m length	<i>Smoke-tight</i> in lieu of <i>fire-resisting division</i> (1)

KEY:

(1) Space shall have a *fixed fire-extinguishing system* in accordance with Clause 6.4.13.

DETECTION AND ALARM**6.4.12 Fixed fire detection and fire alarm system****6.4.12.1 Requirement**

A *fixed fire detection and fire alarm system* shall be installed in—

- a) unmanned machinery spaces of *High Fire Risk*; or
- b) machinery spaces of *High Fire Risk* where the main propulsion or auxiliary machinery, including the main sources of electrical power, are provided with automatic or remote control. This applies even if the machinery is under continuous manned supervision from a control station within the machinery space.

6.4.12.2 Design

The *fixed fire detection and fire alarm system* required in Clause 6.4.12.1 shall be designed, and the detectors positioned so as to detect rapidly the onset of fire in any part of the machinery space. Detection shall operate correctly over the normal ranges of machinery operation, variations of ventilation and anticipated ambient temperature.

NOTE: The NSCV assumes that vessels may operate in ambient outside temperatures that range between 0°C and 50°C. The ambient temperature within machinery, *galley* and other spaces on the vessel will likely exceed these levels. This can affect the correct operation of some detectors.

6.4.12.3 Limitations on the use of thermal detectors

Detection systems using only thermal detectors shall not be used in spaces 5 m or more in height.

NOTE: Dual spectrum smoke and flame detectors are more effective than thermal detectors in spaces of restricted height of less than 5 m.

FIRE FIGHTING**6.4.13 Fixed fire-extinguishing system**

Machinery spaces of *High Fire Risk* shall be fitted with a total flooding *fixed fire-extinguishing system* complying with Clause 4.9.

The *fixed fire-extinguishing system* shall be one of the following:

- a) A gaseous *fixed fire-extinguishing system*;

- b) A high-expansion foam *fixed fire-extinguishing system*;
- c) An aerosol *fixed fire-extinguishing system*; or
- d) An aqueous *fixed fire-extinguishing system*.

6.4.14 Portable fire extinguishers

Portable extinguishers suitable for Class B fires shall be provided for each *High Fire Risk* machinery space in accordance with Table 32. Additional portable fire extinguishers shall be provided for large machinery spaces, sufficient in number and located to ensure that an extinguisher is not more than 10 m walking distance from any point within the space. Where the machinery space is of a size or configuration that would not normally be occupied by persons while the vessel is underway, up to two of the fire extinguishers may be located immediately outside the machinery space entrance.

Portable fire extinguishers shall comply with Clause 4.10 and Chapter 12.

Table 32 — Minimum number of portable fire extinguishers for *High Fire Risk* machinery spaces

Category	Vessel < 10 m measured length	Vessel ≥ 10 m measured length
<i>Fire Risk Category I</i>	1	1 (A)
<i>Fire Risk Category II</i>	1	2 (A)
<i>Fire Risk Category III</i>	1	2 (A)
<i>Fire Risk Category IV</i>	No application	2 (A)

KEY:

(A) Additional extinguishers as required to provide an extinguisher within 10 m walking distance from any point within the space.

6.4.15 Additional fire appliances

A *High Fire Risk* machinery space containing internal combustion machinery of aggregate power greater than 750 kW or an oil-fired boiler shall be provided with wheeled fire extinguishers, *foam making branch pipes* or portable fire extinguishers in accordance with Table 33. The wheeled and portable fire extinguishers and *foam making branch pipes* shall comply with relevant provisions in Clause 4.10, Chapter 12 and Annex J of this Section.

Table 33 — Wheeled fire extinguishers, *foam making branch pipes* or additional portable fire extinguishers for *High Fire Risk* machinery spaces

Space containing	Internal combustion machinery ≥ 750 kW in aggregate	Oil-fired boiler ≥ 175 kW	Oil-fired boiler < 175 kW
<i>Fire Risk Category I</i>	Not required	Not required	Not required
<i>Fire Risk Category II</i>	Two additional 9 L foam portable fire extinguishers for Class B fires (1)	One additional 9 L foam portable fire extinguisher for Class B fires (1)	Not required
<i>Fire Risk Category III</i>	Two additional 9 L foam portable fire extinguishers for Class B fires (1)	Two additional 9 L foam portable fire extinguishers for Class B fires (1)	One additional 9 L foam portable fire extinguisher for Class B fires (1)
<i>Fire Risk Category IV</i>	One 90 L foam-type wheeled extinguisher (2) or one <i>foam making branch pipe</i> with foam concentrate (3)	One 90 L foam-type wheeled extinguisher (2) or one <i>foam making branch pipe</i> with foam concentrate (3)	One additional 9 L foam portable fire extinguisher for Class B fires (1)

KEY:

- (1) Rating to be as specified in Table 26.
- (2) With hose or hoses on reel suitable for reaching any part of the space.
- (3) The *foam making branch pipe* shall comply with Annex J.

6.4.16 Sand

Spaces that contain an oil-fired boiler shall be provided with 0.1 m³ of sand or sawdust impregnated with soda. The sand or soda impregnated sawdust shall be stored in a suitable receptacle with a scoop. An additional portable extinguisher suitable for Class B fires, complying with Clause 4.10, may be substituted as an alternative.

6.5 RO-RO SPACES

6.5.1 Application

6.5.1.1 Closed Ro-Ro spaces

Closed Ro-Ro spaces including *special category spaces* shall comply with Clauses 6.5.2 to 6.5.10.

6.5.1.2 Open Ro-Ro spaces

Open Ro-Ro spaces having a deck above shall comply with Clauses 6.5.2, 6.5.3.1, 6.5.4, 6.5.5, 6.5.6, 6.5.7, 6.5.8 and 6.5.10. Those parts of an *open Ro-Ro space* that are completely open from above need not comply with Clauses 6.5.2, 6.5.3.1, 6.5.4.3, 6.5.7 and 6.5.10.

6.5.1.3 Ro-Ro spaces on weather decks

Ro-Ro spaces on *weather decks* shall comply with Clauses 6.5.4.1, 6.5.6 and 6.5.8.

PREVENTION OF FIRE AND EXPLOSION

6.5.2 Ventilation system

6.5.2.1 Ventilation design and construction

The ventilation system shall be designed and constructed to—

- a) give at least 10 air changes per hour while underway and 20 air changes per hour when stationary at the quayside during vehicle loading and unloading operations;
- b) operate at all times when vehicles are in such spaces;
- c) prevent air stratification and the formation of air pockets;
- d) be entirely separated from other ventilation systems;
- e) have ventilation ducts separated for each such space, where the *Ro-Ro space* is capable of being effectively sealed;
- f) locate the outlet from any exhaust duct in a safe position, having regard to other possible sources of ignition; and
- g) have ventilation ducts, including *fire flaps* and *fire dampers* made of steel, *non-combustible* or *fire-restricting materials*.

6.5.2.2 Open Ro-Ro spaces

6.5.2.2.1 Minimum area of ventilation openings

The minimum area of permanent ventilation openings to an *open Ro-Ro space* shall not be less than:

$$A_V = H_{RR} (0.8 W_{RR} + 0.2 L_{RR})$$

where

A_V = total required area of ventilation openings, in square metres

H_{RR} = mean height of the *open Ro-Ro space*, in metres

W_{RR} = mean width of the *open Ro-Ro space*, in metres

L_{RR} = mean length of the *open Ro-Ro space*, in metres

6.5.2.2.2 Distribution of openings

Ventilation openings shall be arranged to promote natural ventilation throughout the open vehicle space without leaving pockets of uncirculating air where explosive fumes could form. The required area of permanent openings specified in Clause 6.5.2.2.1 above shall be provided by:

- a) arranging the space to be open at both ends; or
- b) providing the space with an opening at one end and openings distributed in the side plating, deckhead or from above.

NOTE: Arrangements for power ventilation may be required to supplement natural ventilation of an *open Ro-Ro space* if the air flow is inadequate to clear the accumulation of explosive gases or fumes that arise while loading or unloading vehicles in port.

6.5.2.3 Power ventilation

Closed Ro-Ro spaces shall be provided with an effective power ventilation system.

6.5.2.4 Ventilation monitoring and control

A power ventilation system shall be—

- a) provided with means to indicate in the *operating compartment* any loss or reduction of the required ventilating capacity;
- b) provided with arrangements to permit a rapid shutdown and effective closure of the ventilation system in case of fire; and
- c) capable of being controlled from a position outside the space served by the ventilation system.

6.5.3 Electrical equipment

6.5.3.1 Electrical equipment suited for hazardous conditions

Electrical equipment located in the following positions shall be designed, manufactured and installed for operation in hazardous mixtures of petrol vapour and air:

- a) On any *closed* or *open Ro-Ro* deck, or vehicle platform if fitted, on which such explosive vapours might be expected to accumulate. This requirement does not apply to vehicle platforms having openings of sufficient size and distribution to permit the downward escape of petrol gases.
- b) In an exhaust ventilation duct that serves a *closed* or *open Ro-Ro space*.

NOTE: Refer to NSCV Part C Section 7B for the requirements applicable to electrical installations in hazardous conditions. Guidance on the installation of electrical equipment in hazardous areas is available in Standards Australia Handbook HB13 Electrical equipment for hazardous areas.

6.5.3.2 Location of electrical equipment

Electrical equipment and wiring that may constitute a source of ignition of flammable vapours shall be installed at least 450 mm above the deck or platform, unless the installation of electrical equipment and wiring at less than 450 mm above the deck or platform is necessary and unavoidable for the safe operation of the vessel.

CONTAINMENT OF FIRE

6.5.4 Structural protection

6.5.4.1 Insulation

Boundaries of *Ro-Ro spaces* shall be insulated in accordance with Clause 3.7. However, the standing deck of a *Ro-Ro space* need only be insulated on the underside if the space is protected by an aqueous *fixed fire-extinguishing system*.

6.5.4.2 Limitations on height of special category spaces

The height of a *special category space* may extend more than one deck provided the total overall clear height does not exceed 10 m.

6.5.4.3 Fire doors in boundaries

6.5.4.3.1 Coamings

Fire doors in boundaries of *Ro-Ro spaces* leading to spaces below the deck shall be arranged with coamings of a height of at least 100 mm.

6.5.4.3.2 Indicators

In Class 1 vessels, indicators shall be provided in the *operating compartment* to indicate when any fire door leading to or from a *Ro-Ro space* is closed.

MEANS OF ESCAPE

6.5.5 Means of escape

At least two means of escape shall be provided from *Ro-Ro spaces*. The escape routes shall provide a safe route to the survival craft embarkation deck and shall be located at the fore and aft ends of the space.

DETECTION AND ALARM

6.5.6 Fixed fire detection and fire alarm system

6.5.6.1 Remote indicators

A *fixed fire detection and fire alarm system*, complying with the requirements of Clause 4.5 and Chapter 12, shall be provided. Detectors shall be located and spaced so that the ventilation system does not affect their operation or reduce their effectiveness.

6.5.6.2 Manually operated call points

Manually operated call points shall be provided in the *Ro-Ro space*, located so that no part of the space is more than 20 m walking distance from a call point. A point shall also be placed close to each escape exit from such spaces.

6.5.6.3 Television surveillance

A television surveillance system shall be provided in *special category spaces*. Alternatively, a fire patrol may be substituted where the vessel has sufficient crew and a documented Safety Management System.

NOTE: Part E of this National Standard specifies requirements for operational procedures and Safety Management Systems.

6.5.6.4 Open Ro-Ro spaces and Ro-Ro spaces on weather decks

The fire detectors specified in Clause 6.5.6.1 may be omitted in *open Ro-Ro spaces* and *Ro-Ro spaces on weather decks* provided a television surveillance system is fitted and maintained.

FIRE FIGHTING

6.5.7 Fixed fire-extinguishing system

Each *closed Ro-Ro space* and each *open Ro-Ro space* having a deck above shall be fitted with a fixed manual or automatic pressure water-spraying

system complying with Clause 4.9 and Chapter 12. The extinguishing system shall protect all parts of each deck and vehicle platform.

NOTE: *Fixed fire-extinguishing systems* employing other types of extinguishing media that have been shown by full-scale test to be effective in controlling fires likely to occur in such a space could be considered as an equivalent solution, taking into account persons within the space may, in some circumstances, be passengers. Testing should occur in conditions simulating a flowing petrol fire in the space. See Clause 2.10.

6.5.8 Fire hose appliances

Within any *Ro-Ro space*, hydrants shall be arranged so that the water jets from two different hydrants can reach any location within the space, each jet being supplied by a single length of hose.

6.5.9 Other fire appliances

Each *Ro-Ro space* shall be provided with the following *fire appliances*:

- a) *Water fog applicators* to the extent specified in Table 34, complying with Chapter 12.
- b) *Foam making branch pipes* and foam concentrate to the extent specified in Table 34, complying with Chapter 12 and Annex J.
- c) Portable fire extinguishers suitable for Class B fires, complying with Clause 4.10 and Chapter 12. At least one portable extinguisher shall be located at each access to the space for fire control. The total number and location of portable fire extinguishers shall be such that no point in the space is more than approximately 15 m walking distance from an extinguisher.

Table 34 — Foam making branch pipes and water fog applicators in *Ro-Ro spaces*

Category	Foam making branch pipes	Water fog applicators
<i>Fire Risk Category I</i>	Not required	1
<i>Fire Risk Category II</i>	1	2
<i>Fire Risk Category III</i>	1	3
<i>Fire Risk Category IV</i>	2	3

6.5.10 Scuppers and drainage

Where the *fixed fire-extinguishing system* fitted in a *Ro-Ro space* is a fixed pressure water-spraying system, the *Ro-Ro space* shall be provided with scuppers or drainage and pumping facilities to ensure that water discharged from the system is rapidly discharged overboard. If the scuppers are normally kept closed to maintain watertight or weathertight integrity, they shall be capable of being opened from a place outside the protected space.

NOTE: The accumulation of quantities of water on the deck or decks consequent to the operation of the fixed pressure water-spraying system could lead to a serious loss of stability and possible capsizing of the vessel.

6.6 CARGO SPACES CONTAINING DANGEROUS GOODS

6.6.1 Application

The requirements of Clause 6.6 shall apply to vessels and cargo spaces used for the carriage of *dangerous goods*. It excludes:

- a) spaces containing *limited quantities* of *dangerous goods*;
- b) store spaces containing *minor quantities* of *dangerous goods* of *flammable* or *combustible liquids* that comply with Clause 6.8; and
- c) spaces containing *flammable and combustible vessel's stores* that comply with Clause 6.8.

NOTE: Clause 6.6 is intended to be complementary to any specific laws within a jurisdiction pertaining to the carriage of *dangerous goods*. Where there is any conflict, the laws pertaining to the carriage of *dangerous goods* have precedence.

EXAMPLE

Examples of *dangerous goods*:

- Explosives,
- kerosene,
- petrol,
- gas oil,
- bottled LPG,
- battery acid and wet batteries,
- paint thinners, oil paints.

6.6.2 Classes of dangerous goods voyages

For the purposes of Clause 6.6, there are two classes of *dangerous goods* voyages:

DGV 1—

A voyage where *dangerous goods* are carried not meeting the voyage criteria specified for DGV 2.

DGV 2—

A voyage that is—

- a) made by a Class 2 or Class 3;
- b) within Class B geographical limits;
- c) carrying *dangerous goods* on the *weather deck*; and
- d) where the total quantity of *dangerous goods* carried does not exceed—
 - i) 5000 kg of packaged *dangerous goods*; or
 - ii) 2000 kg of *flammable liquids* or gases.

PREVENTION OF FIRE AND EXPLOSION

6.6.3 Packaging, containment and stowage

The requirements for *dangerous goods* in this Section are predicated on the assumption that the packaging, containment, stowage, segregation, marking of, and declarations for *dangerous goods* on vessels comply with the National Standard for the Storage and Handling of Workplace Dangerous Goods. The fire training manual and fire safety operational

booklet required in Chapter 5 shall include appropriate directions and information to promote and facilitate such compliance by those operating the vessel.

NOTE: Jurisdictions have specific legislation pertaining to the carriage and storage of *dangerous goods* that must be met.

FIRE FIGHTING

6.6.4 Additional requirements for fire hose appliances

6.6.4.1 DGV 1 vessels and DGV 2 vessels

Vessels carrying *dangerous goods* shall, except where specifically stated in SOLAS Chapter II-2 Regulation 19, or HSC Code Clause 7.17, be provided with fire hose appliances that comply with the following:

- a) Pumps and piping shall provide water of sufficient pressure and quantity to simultaneously supply the number of water jets specified in Table 35. The performance of each water jet shall comply with Clause 4.7.2.
- b) Hydrants shall be located to enable the required number of water jets to be simultaneously trained on any part of the *dangerous goods* cargo space when empty. Two water jets shall be supplied by a single length of fire hose and the remainder may be supplied by two lengths of fire hose.

6.6.4.2 DGV 1 vessels

On a DGV 1 vessel there shall be an immediate availability of water for the fire hose appliances.

NOTE: This can be achieved either by permanent pressurisation to effect automatic starting of the pump, or by suitably placed remote starting arrangements for the pump.

Table 35 — Number of simultaneous water jets to be trained on any part of a cargo space for *dangerous goods*

Category	DGV 1	DGV 2
<i>Fire Risk Category I</i>	3	2
<i>Fire Risk Category II</i>	3	2
<i>Fire Risk Category III</i>	3	Not permitted
<i>Fire Risk Category IV</i>	4	Not permitted

Table 36 — Additional *dangerous goods* fire safety requirements

Requirement	DGV 1	DGV 2
Cooling or flooding of under deck cargo space	As per SOLAS or HSC Code	Not required
Sources of ignition (1)	As per SOLAS or HSC Code	Not required
<i>Fixed fire detection and fire alarm system</i>	As per SOLAS or HSC Code	Visual monitoring or fire patrol
Ventilation	As per SOLAS or HSC Code	Not required
Bilge pumping	As per SOLAS or HSC Code	Not required
Personal protection	As per SOLAS or HSC Code	Protective clothing as per SOLAS or HSC Code but only one set required
Portable fire extinguishers	As per SOLAS or HSC Code	1 x 12 kg dry powder extinguisher or equivalent
<i>Fixed fire-extinguishing system</i>	As per SOLAS or HSC Code	Not required
Separation of <i>Ro-Ro spaces</i>	As per SOLAS or HSC Code	Not required
Separation between <i>Ro-Ro space</i> and <i>weather deck</i>	As per SOLAS or HSC Code	As per SOLAS or HSC Code

KEY:

(1) The electrical installation shall be designed, manufactured and installed to operate safely in hazardous conditions applicable to the particular class of *dangerous goods*, refer to NSCV Part C Section 5B.

6.6.4.3 **DGV 2 vessels**

On a DGV 2 vessel there shall be ready availability of water for the fire hose appliances.

NOTE: Additional pumping capacity may be needed on a vessel in order to comply with this requirement. This additional capacity may be provided by a powered fixed or portable pump complying with Clause 4.7.4 of capacity to provide the aggregate water supply required by Clause 6.6.4.1.

6.6.5 **Other fire safety requirements**

In addition to Clause 6.6.4, a vessel engaged in the carriage of *dangerous goods* shall be provided with fire safety measures specified in SOLAS Chapter II-2 Regulation 19, or HSC Code Clause 7.17 to the extent specified in Table 36, as applicable to the particular class of *dangerous goods*, mode of carriage and type of *dangerous goods* voyage.

6.6.6 **Document of compliance**

A special service notation (DG) on the Certificate of Survey shall record the compliance of a vessel with the requirements of Clause 6.6 for

construction and equipment. The allowable class or classes of *dangerous goods* shall be recorded as a condition on the Certificate of Survey.

NOTE: Refer to Part B Chapter 3 for further information on special service notation.

6.7 HELIDECKS

6.7.1 Application

The provisions of this Clause apply to vessels equipped with *helidecks*.

NOTE: Where helicopters land or conduct winching operations on an occasional or emergency basis on vessels without *helidecks*, the fire-fighting equipment specified elsewhere in this Section would normally be utilised.

CONTAINMENT OF FIRE

6.7.2 Structure

6.7.2.1 Construction

Helidecks shall be of steel or other *non-combustible* material. If the *helideck* forms the deckhead of a deckhouse or superstructure, it shall be insulated in accordance with Table 7, Table 8 or Table 9.

NOTE: The heat of a fire may adversely affect the strength of platforms of aluminium or other low melting point metal. Upon exposure to fire, the structure of such platforms would normally be subject to structural analysis to determine its suitability for further use.

6.7.2.2 Protection of spaces beneath the helideck

Where the *helideck* platform is located above a deckhouse—

- a) the deckhouse top shall have no openings;
- b) the bulkheads forming exposed boundaries of the deckhouse under the platform shall have no openings; and
- c) windows under the platform shall be provided with shutters of *non-combustible material*.

Subclauses b) and c) need not apply where the *helideck* overhangs the deckhouse beneath not less than 1 m beyond the boundary of the deckhouse and the overhang is—

- a) of steel; or
- b) of *non-combustible material* protected to the level of a *fire-resisting division*.

6.7.3 Drainage

Drainage systems for *helidecks* shall—

- a) be constructed of steel;
- b) lead directly overboard independent of any other system; and
- c) be designed so that drainage does not fall onto any part of the vessel.

MEANS OF ESCAPE

6.7.4 Means of escape

A *helideck* shall be provided with at least two points of access, each capable of serving as both a means of escape and access for fire-fighting and rescue personnel. The access points shall be located as far apart from each other as practicable, preferably on opposite sides of the *helideck*.

6.7.5 Emergency equipment

The following equipment shall be stored in a location that both provides protection from the elements and facilitates the immediate use of the equipment:

- a) Adjustable wrench, 300 mm.
- b) Blanket, woollen or similar fire-resistant type.
- c) Cutters, bolt 600 mm.
- d) Hook, grab or salving.
- e) Hacksaw, heavy duty complete with 6 spare blades.
- f) Ladder, 3 m in length.
- g) Life line 5 mm diameter x 15 m in length.
- h) Pliers, side cutting.
- i) Set of assorted screwdrivers.
- j) Harness knife complete with sheath.

FIRE FIGHTING

6.7.6 Fire hose appliances

Each fire main pump and the fire main piping shall provide water of sufficient pressure and quantity to simultaneously supply at least two water jets from nozzles of dual-purpose type. The performance of each of the water jets shall comply with Clause 4.7.2. The hydrants shall be located to enable the two water jets to reach any part of the *helideck* using a single length of fire hose.

6.7.7 Foam application system

A foam application system shall be provided and stored near a means of access to the *helideck*. The foam application system shall consist of a fire monitor or *foam making branch pipe* capable of delivering foam to all parts of the *helideck* in all weather conditions in which helicopters can operate.

The foam application system shall—

- a) be capable of delivering the discharge rate specified in Table 37 for at least five minutes; and

- b) have a principal agent suitable for use with salt water⁵.

A foam making branch pipe, where provided, shall comply with Chapter 12 and Annex J apart from the increased discharge rate specified in Table 37 and the omission of the requirement to carry spare concentrate.

Table 37 — Helideck foam applicator system discharge rates

Helicopter overall length	Discharge rate of foam solution (L/min)
< 15 m	250
≥ 15 m and > 24 m	500
≥ 24 m and > 35 m	800

6.7.8 Fire extinguishers

The following fire extinguishers, complying with Chapter 12, shall be provided and stored near the means of access to the *helideck*:

- a) At least two wheeled dry powder extinguishers having a total capacity of not less than 45 kg.
- b) Portable carbon dioxide extinguishers of a total capacity of not less than 18 kg.

6.7.9 Fire-fighters' outfits

In addition to those that might be specified in Clause 4.11, two sets of fire-fighters' outfits shall be stored in close proximity to the *helideck*.

6.7.10 Helicopter refuelling and hangar facilities

Where provided on a vessel, helicopter refuelling and hangar facilities shall comply with the requirements of SOLAS Chapter II-2 Regulation 18.7.

NOTE: Standards specified in SOLAS Chapter II-2 Regulation 18.7 include requirements for the location of fuel tanks, remote shut-down of fuel, spillage of fuel, operation of fuel pumping units, electrical installations, electrical bonding and ventilation.

6.8 STORE SPACES CONTAINING PACKAGED FLAMMABLE OR COMBUSTIBLE LIQUIDS

6.8.1 Application

Clause 6.8 shall apply to store spaces containing no more than 1000 L of *flammable* and *combustible liquids*, except—

- a) Store spaces that contain *flammable* and/or *combustible liquids* that are classified as *dangerous goods* (NOHSC 15) in a quantity that exceeds the applicable *minor quantity of dangerous goods*. Such spaces shall comply with Clause 6.6.

⁵ Refer to the International Civil Aviation Organization Airport Services Manual, part 1 - Rescue and Fire fighting, Chapter 8 - Extinguishing Agent Characteristics, Paragraph 8.1.5 - Foam Specifications, Table 8-1, Level 'B'.

- b) Spaces containing freestanding non-portable tanks for fuel that comply with Part C Subsection 5A Chapter 4.
- c) Spaces complying with relevant provisions of Clauses 6.9.4 or 6.9.5.

PREVENTION OF EXPLOSION AND IGNITION

6.8.2 Prevention of accumulated vapours and gases

Storage spaces containing *flammable liquids* or gases shall have direct access from open decks only. Pressure-adjusting devices and relief valves shall exhaust within the compartment.

The ventilation of store spaces shall be sufficient under normal conditions to prevent accumulation of flammable or explosive vapours or dangerous gases. The ventilation arrangements shall be kept separate from other spaces on the vessel.

6.8.3 Electrical equipment

Except as necessary for service within the space, electrical wiring and fittings shall not be permitted within compartments used for the storage of packaged *flammable* or *combustible liquids*.

Any electrical equipment and wiring that is fitted within such compartments shall be installed at least 450 mm above the deck. The electrical installation in such spaces, and in any ventilation ducting serving such spaces, shall be designed, manufactured and installed to operate safely in hazardous conditions that may arise from spilt *flammable* or *combustible liquids* or explosive mixtures of vapour or gas.

NOTE: Refer to NSCV Part C Section 7B for the requirements applicable to electrical installations in hazardous conditions. Guidance on the installation of electrical equipment in hazardous areas is available in Standards Australia Handbook HB13: *Electrical equipment for hazardous areas*.

6.8.4 Information to reduce the likelihood and consequences of fire

Where required in Chapter 5, the fire training manual and fire safety operational booklet shall include:

- a) appropriate directions and information on packaging, containment and stowage of *flammable* and/or *combustible liquids* to promote and facilitate compliance with the National Standard for the Storage and Handling of Workplace Dangerous Goods, see Clause 6.6.3; and
- b) instructions requiring *flammable* and/or *combustible liquids* to be stored only in spaces specified.

SPREAD OF FIRE

6.8.5 Separation from other spaces

Store spaces containing *flammable liquids* shall be separated from other spaces on the vessel by gas-tight bulkheads or enclosures to enable the space to be sealed in the event of a fire.

FIRE DETECTION

6.8.6 Fixed fire detection and fire alarm system

Spaces containing *flammable liquids* shall be provided with a *fixed fire detection and fire alarm system* complying with Clause 4.5.

FIRE FIGHTING

6.8.7 Fixed fire-extinguishing system

Spaces containing *flammable liquids* shall be protected by a *fixed fire-extinguishing system* complying with Clause 4.9. The *fixed fire-extinguishing system* shall be operable from outside the protected space.

6.9 FLAMMABLE AND COMBUSTIBLE VESSEL'S STORES

6.9.1 Quantity of stores

Arrangements for the storage of *flammable and combustible vessel's stores* shall be designed to provide for the minimum quantity of such stores needed for the operation or function of the vessel. The design quantity of *flammable and combustible vessel's stores* shall not exceed the quantity listed under Clause 6.8.1.

6.9.2 Information to reduce the likelihood and consequences of fire

Where required in Chapter 5, the fire training manual and fire safety operational booklet shall include:

- a) appropriate directions and information on packaging, containment and stowage of *flammable and combustible vessel's stores* to promote and facilitate compliance with the National Standard for the Storage and Handling of Workplace Dangerous Goods, see Clause 6.6.3; and
- b) instructions requiring *flammable and combustible vessel's stores* to be kept to the minimum necessary and stored only in spaces specified.

6.9.3 Location

In designing the arrangement of a vessel, *flammable and combustible vessel's stores* other than gas cylinders shall be stored—

- a) in store spaces complying with Clause 6.8;
- b) on the open deck complying with Clause 6.9.4; or
- c) in a stores locker complying with Clause 6.9.5.

The storage of gas cylinders shall comply with Clause 6.10.

6.9.4 Open deck storage

Flammable or combustible liquids stored on the open deck shall be stowed in the weather and located so that they may be readily jettisoned overboard in the event of a fire. Stowage locations shall not be in the vicinity of hatches and doors, *galleys*, locations where hot work is performed, ventilation intakes or exhausts, or in locations where helicopter engine exhaust could impinge

on such storage. Stowage shall be aft, if possible, and in the location that poses the least threat to the vessel in the event of fire or explosion of the *flammable or combustible liquids*.

6.9.5 Stores locker

6.9.5.1 Application

Clause 6.9.5 applies to stores lockers for *flammable and combustible vessel's stores* of volume not greater than 10 m³ that are remote from *Accommodation Spaces*.

6.9.5.2 General

The stores locker shall comply with the requirements of Clause 6.8, except that the requirement for a *fixed fire-extinguishing system* in Clause 6.8.7 shall be replaced by the requirements listed in Clause 6.9.5.3.

6.9.5.3 Fire extinguishing

The stores locker shall be provided with one of the following:

- a) A portable fire extinguisher and discharge opening complying with Clause 7.4.3. The required portable fire extinguisher shall be stowed adjacent to the discharge opening.
- b) A fire hydrant adjacent to the space and a port leading into the space arranged to facilitate the use of a fire hose appliance fitted with a fog spray nozzle without having to enter the protected space.
- c) A fixed branch connection and valve from the fire main to a fog spray nozzle located within the protected space.
- d) A dry powder *fixed fire-extinguishing system* complying with Chapter 12, designed to deliver a quantity of powder at least 0.5 kg/m² of deck area.

6.10 STORAGE OF GAS CYLINDERS FOR COMPRESSED, LIQUEFIED OR DISSOLVED GASES FOR THE VESSEL'S USE

6.10.1 Marking

Gas cylinders for the vessel's use shall be clearly marked by means of—

- a) prescribed identifying colours;
- b) a clearly legible identification of the name; and
- c) chemical formula of their contents .

6.10.2 Gas cylinder storage location

Cylinders containing gases and expended cylinders of the same shall be stored on open decks or in lockers located above the weather deck.

Storage for gas cylinders on open decks shall comply with Clause 6.9.4. Lockers for cylinders of flammable gases shall comply with Clause 6.9.5. Lockers for cylinders of gases that are not flammable shall comply with Clauses 6.8.2 and 6.8.5 above.

Separate storage shall be provided for each type of gas. Lockers used for the storage of gases shall not be used for storage of other combustible products nor for tools or objects not part of the gas distribution system.

6.10.3 Protection of cylinders and piping

Cylinders shall be secured against movement and shall be protected against excessive variations in temperature and the direct rays of the sun. All valves, pressure regulators and pipes leading from gas cylinders shall be protected against damage.

CHAPTER 7 MODERATE FIRE RISK SPACES

7.1 SCOPE

This Chapter lists requirements from Chapter 3 and Chapter 4 that are applicable to *Moderate Fire Risk Spaces* and specifies particular requirements that are additional to or modify the general requirements in Chapter 3 and Chapter 4.

7.2 APPLICATION

This Chapter applies to spaces defined by Clause 1.8 as *Moderate Fire Risk Spaces*. Specific clauses within this Chapter that apply are listed in Table 38.

Table 38 — Application of Chapter 7

Clause	Subject
Clause 7.3	General requirements applicable to Moderate Fire Risk Spaces
Clause 7.4	Machinery space of moderate fire risk
Clause 7.5	Galley spaces

7.3 GENERAL REQUIREMENTS APPLICABLE TO MODERATE FIRE RISK SPACES

7.3.1 General

Moderate Fire Risk Spaces shall comply with the clauses in Chapter 3 and Chapter 4 specified in Table 39.

Table 39 — General deemed-to-satisfy provisions applicable to *Moderate Fire Risk Spaces*

Clause	Subject
Clause 3.3	Engine exhausts, boiler and galley uptakes
Clause 3.4	Certain highly flammable materials prohibited
Clause 3.5	Insulation
Clause 3.6	Paints, varnishes & other finishes on passenger vessels
Clause 3.7	Structural fire protection
Clause 3.7.4	Combustible veneers
Clause 3.9	Maintenance of structural integrity
Clause 3.10	Materials for overboard fittings

(continued....)

Table 39 cont.

Clause	Subject
Clause 4.2	Remote stops for ventilation and exhaust fans
Clause 4.3	Ventilation closing appliances
Clause 4.4	Centralised fire control functions on passenger vessels
Clause 4.5	Fire detection and fire alarm system
Clause 4.7.5	Fire main and hydrants for fire hose appliances
Clause 4.7.6	Fire hoses and nozzles
Clause 4.9	Fixed
Clause 4.10	Portable and wheeled fire extinguishers

FIRE GROWTH POTENTIAL

7.3.2 Primary deck materials and coverings

Primary deck materials, floor plates, floor plate supporting structure and coverings within *Moderate Fire Risk Spaces* shall—

- a) be of material that is *non-combustible* unless, in the case of deck materials and floor plate supporting structure, they form part of the primary hull structure of a vessel constructed of *combustible materials*; and
- b) not absorb oil or other combustible or flammable liquids.

FIRE FIGHTING

7.3.3 Portable fire extinguishers

Except as specified otherwise in this Chapter, one portable fire extinguisher complying with Clause 4.10 shall be provided in, or adjacent to, each *Moderate Fire Risk Space*.

7.4 MACHINERY SPACE OF MODERATE FIRE RISK

PREVENTION OF FIRE AND EXPLOSION

7.4.1 Fuel tanks

The following fuel tanks shall not be situated within machinery spaces of *Moderate Fire Risk*:

- a) Fuel tanks not complying with Clause 6.4.1.2.
- b) Fuel tanks containing fuel of flashpoint less than 60°C.

Fuel and lubricating oil tanks shall be located to ensure that any spillage or leakage cannot constitute a fire or explosion hazard by falling on heated surfaces.

DETECTION AND ALARM

7.4.2 Fixed fire detection and fire alarm system

7.4.2.1 Application

A *fixed fire detection and fire alarm system* complying with Clause 4.5 shall be installed in machinery spaces of *Moderate Fire Risk* on vessels other than those of *Fire Risk Category I*.

7.4.2.2 Design

The *fixed fire detection and fire alarm system* required in Clause 7.4.2.1 shall be designed, and the detectors positioned so as to detect rapidly the onset of fire in any part of the machinery spaces. Fire detection shall operate correctly over the normal ranges of machinery operation, variations of ventilation and anticipated ambient temperature.

7.4.2.3 Limitations on the use of thermal detectors

Detection systems using only thermal detectors shall not be used in spaces higher than 5 m.

NOTE: Dual spectrum flame detectors are more effective than thermal detectors in spaces of restricted height of less than 5 m.

FIRE FIGHTING

7.4.3 Small machinery spaces

7.4.3.1 Portable fire extinguisher

The portable fire extinguisher referred to in Clause 7.3.3 that is provided for a *small machinery space* shall comply with the following:

- a) The extinguishing agent shall be discharged into the *small machinery space* from outside the space without having to open the primary access. The *small machinery space* shall be provided with a discharge opening complying with Clause 7.4.3.2.
- b) The portable extinguisher shall be stowed outside the *small machinery space*.
- c) The extinguishing agent of the portable fire extinguisher shall be able to flood the entire space and extinguish a fire within the *small machinery space*.
- d) The extinguishing capacity of the portable extinguisher shall be sufficient for the volume of the *small machinery space*.

NOTES:

1. A 5 kg carbon dioxide fire extinguisher is needed to flood a space having a volume of 4.7 m³.
2. A 4.5 kg dry powder extinguisher is needed to flood a space having a volume of 5 m³.
3. A 9 kg dry powder extinguisher is needed to flood a space having a volume of 10 m³.

7.4.3.2 Discharge opening

The discharge opening shall be—

- a) readily identifiable;
- b) sized to accept the discharge nozzle;
- c) open or able to be opened to provide ready access for discharge of the agent into the engine space; and
- d) located so the required size of extinguisher can be operated in a position that will allow discharge of the extinguishing agent.

7.5 GALLEY SPACES

PREVENTION OF FIRE

7.5.1 Restraint of cooking utensils

Means shall be provided on the top surfaces of cooking ranges to prevent both deep and shallow cooking utensils from sliding across or off the range, at pitch or roll angles up to 30° from the horizontal in any direction.

NOTES:

1. Fiddle bars on the top of marine cooking ranges are usually provided to restrain cooking utensils, see Figure 6.
2. Proposals to omit fiddle bars on larger vessels operating in smooth waters would be assessed as an equivalent solution taking into account the likely motions and operating accelerations.

FIRE GROWTH POTENTIAL

7.5.2 Fire protection in way of cooking appliances

7.5.2.1 *General*

Cooking appliances shall be installed to reduce the risks of fire caused by—

- a) heat radiated from the cooking element or flame; and
- b) ignition of cooking fats and oils.

7.5.2.2 *Adjacent fittings*

Materials, shelves, range hoods and exhaust fans adjacent to a cooking appliance shall comply with Table 40 modified for marine applications as specified in Clause 7.5.2.4

Table 40 — Applicable standards for adjacent fittings

<i>Energy source</i>	<i>Large galleys</i>	<i>Small galleys</i>
Gas	Clause 7.5.2.3 (1)	Modified AS 5601 for domestic cooking appliances or ISO 9094 (1)
Electricity	Clause 7.5.2.3	Modified AS 5601 for domestic cooking appliances or ISO 9094
Liquid fuel	Clause 7.5.2.3	ISO 9094

KEY:

- (1) Where ISO 9094 is applied, the gas energy legislation of a jurisdiction may require that materials adjacent to gas installations also comply with AS 5601.

7.5.2.3 Large galleys

Materials adjacent to a cooking appliance in a *large galley* within 250 mm of the perimeter shall be protected by *non-combustible* surfaces. This protection shall extend from 100 mm below the cooking surface of the appliance to a distance E above the cooking surface determined from Table 41. See Figure 6(a).

Table 41 — Dimension E in *large galleys*

Appliance	Dimension E mm
Solid grill plate, deep fryer (top of pan)	600
Open flame appliance (i.e. hotplate burner)	1050
Chinese cooking table, griddle, barbecue, char grill or open top flare grill	1350

7.5.2.4 Modifications to AS 5601 applicable to small galleys

Materials adjacent to a domestic cooking appliance in a *small galley* shall comply with the following:

- a) In addition to the protection of combustible surfaces near a domestic cooking appliance required under AS5601 Clause 5.12.1, bulkheads, linings and cabinets not so protected but within 200 mm of the periphery of a burner of a cooking appliance shall be constructed of materials complying with Table 42. These materials shall extend from 10 mm below the lowest point of the *hob* to 450 mm above the highest point of the *hob* of the appliance. See Figure 6(b).
- b) Where a gimballed cooking range is fitted, the enclosure shall comply with Table 42 and dimensions A, B, C, D defining the extent of protection of combustible surfaces in Clause 5.12.1 of AS 5601 shall take into account the extreme limits of movement of the cooking surface. See Figure 6(c).

Table 42 — Fire properties of adjacent bulkheads, linings and cabinets in *small galleys*

Category	Properties of adjacent bulkheads, linings and cabinets
<i>Fire Risk Category I</i>	<i>Non-combustible or low flame spread</i>
<i>Fire Risk Category II</i>	<i>Non-combustible or low flame spread</i>
<i>Fire Risk Category III</i>	<i>Non-combustible or low flame spread</i>
<i>Fire Risk Category IV</i>	<i>Non-combustible</i>

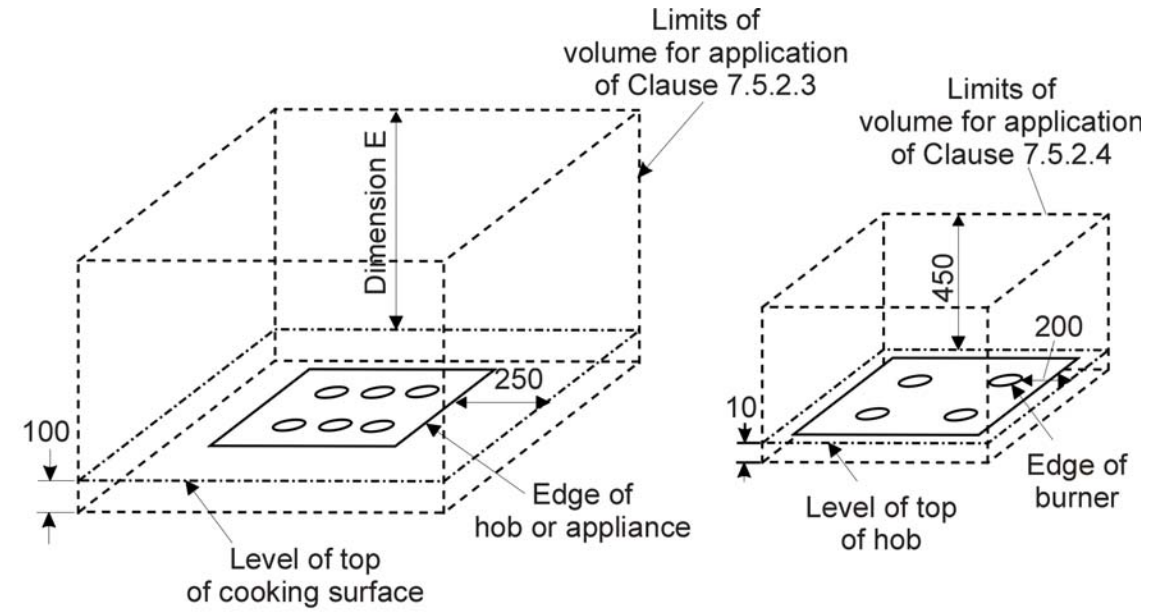

a) Commercial cooking appliance

b) Domestic cooking range

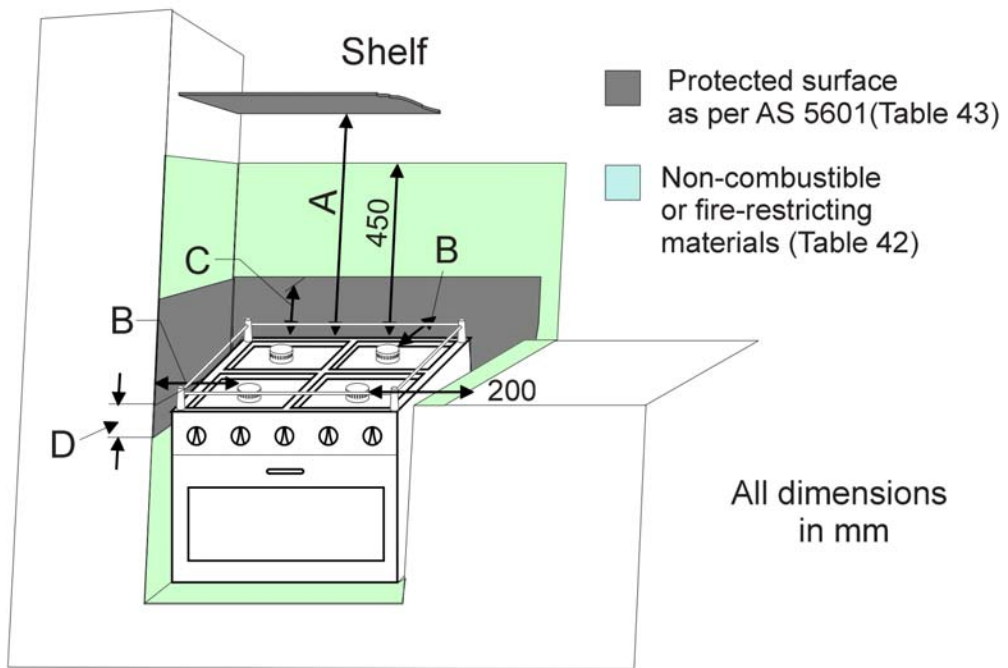

c) Small galley gimballing cooking range

Figure 6 — Protection in vicinity of a cooking range

Table 43 — Key to Figure 6(c)

Measurement	Key in Figure 6	Description of surfaces to be protected by non-combustible materials
Overhead clearance	A	Downward facing combustible surfaces between the highest part of the <i>hob</i> and a line not less than 600 mm above the highest part of the <i>hob</i> ; see Clause 7.5.2.5. NOTE: Downward facing surfaces shall not be fitted less than 450 mm above the highest part of the <i>hob</i> .
Upper vertical clearance	B & C	Vertical combustible surfaces between the periphery of the nearest burner to a point 200 mm horizontally from the periphery of the burner, and between the highest part of the <i>hob</i> and a line 150 mm above the highest part of the <i>hob</i> ; see Clause 7.5.2.5.
Lower vertical clearance	B & D	Vertical combustible surfaces between the periphery of the nearest burner to a point 200 mm horizontally from the periphery of the burner, and between the highest part of the <i>trivet</i> and a line 10 mm below the highest part of the <i>hob</i> ; see Clause 7.5.2.5.

7.5.2.5 **Protection of a combustible substrate near a cooking appliance**

If, when complying with the requirements for a protected surface under AS 5601 Clause 12.1, a *non-combustible* surface is applied over a *combustible* substrate, additional protection shall be provided for the *combustible material* to ensure that its temperature does not exceed 65° C above ambient after a period of prolonged normal operation. Protection of the *combustible* substrate may be by—

- a) covering the substrate with sheet metal having a minimum thickness of 0.4 mm; thermally insulated from the supporting substrate to prevent combustion of the substrate;
NOTE: The thermal insulation may be achieved by an air gap or the use of a suitable material. Refer to AS 5601 Appendix C.
- b) an integral splash-back on the appliance; or
- c) the fixing of 5 mm thick ceramic tiles to the surface of the *combustible* substrate.

7.5.2.6 **Curtains and fabrics**

Free hanging curtains or other fabrics shall not be fitted in *large galleys*. In *small galleys*, free hanging curtains or other fabrics shall not be fitted within 300 mm of the perimeter of a cooking range. These curtains and fabrics shall not come closer than 700 mm above the highest point of the *hob* of the cooking range.

7.5.3 **Exhaust hoods and ducts**

7.5.3.1 **Application**

A *large galley* shall be provided with an exhaust hood and duct serving each *galley* range, deep fat cooker, or similar appliance.

7.5.3.2 General requirements for exhaust hoods and ducts

The exhaust hood and duct shall be—

- a) constructed of steel or similar metal;
- b) insulated in accordance with the requirements of Clause 3.3;
- c) fitted with a grease trap that is readily removable for cleaning;
- d) fitted with suitably located hatches for inspection and cleaning;
- e) fitted with a *fire flap* located in the lower end of the duct; and
- f) provided with remote-control arrangements near the entrance to the *galley* for —
 - i) operating the *fire flap* in the lower end of the duct; and
 - ii) shutting off the exhaust fans.

NOTE: The regular cleaning of grease traps is an activity that should be addressed as part of operational preparedness required in Part E of this standard.

CONTROL OF SMOKE SPREAD

7.5.4 Separation of galley spaces

Unless otherwise specified in Table 44, a *galley* space shall be separated from other spaces by *smoke-tight* divisions.

Table 44 — Separation of galleys from other spaces

Category	Large galleys	Small galleys
<i>Fire Risk Category I</i>	Required	Not required
<i>Fire Risk Category II</i>	Required	Required if > 36 passengers
<i>Fire Risk Category III</i>	Required	Required
<i>Fire Risk Category IV</i>	Required	Required

7.5.5 Fire flaps in ventilation ducts

Where a galley is required to be separated under Clause 7.5.4, an automatically operated *fire flap* shall be fitted in the *galley* ventilation duct near its opening into the *galley*.

7.5.6 Separation of ventilation ducts

Ventilation ducts to and from *galley* spaces on vessels of *Fire Risk Category III* or *IV* shall be separated from each other and from the ventilation systems serving other spaces. On other vessels having *galleys* that are required to be separated under Clause 7.5.4, the ventilation systems need not be completely separated, but shall have separate ducts if served from a ventilation unit that serves other spaces.

FIRE FIGHTING

7.5.7 Portable fire extinguishers and fire blankets

Portable fire extinguishers and fire blankets shall be provided for *galley* spaces in accordance with Table 45. Fire blankets shall comply with Chapter 12 and shall be of minimum size 1.8 m x 1.2 m.

NOTE: One fire extinguisher for a *galley* may be located immediately outside the *galley* entrance.

Table 45 — Portable fire extinguishers and fire blankets for *galleys*

<i>Galley</i> description	Extinguishers for Class F fires		Fire blankets	
	<i>Fire Risk Category</i> I and II	<i>Fire Risk Category</i> III and IV	<i>Fire Risk Category</i> I and II	<i>Fire Risk Category</i> III and IV
<i>Small galley</i>	0 (A)	1	1	1
<i>Large galley</i>	1	2	1	2

KEY:

(A) At least one *Accommodation Space* extinguisher rated for Class B fires shall be located in a place readily accessible from the *galley*.

7.5.8 Galley automatic local fire-extinguishing system

A galley automatic local fire-extinguishing system shall be fitted to protect each deep fat cooker on any vessel and each cooking range or similar appliance in *large galleys* on vessels of *Fire Risk Category* III or IV carrying more than 36 passengers.

The automatic local fire-extinguishing system shall comply with Chapter 12 and shall protect the appliance, hood plenum and exhaust duct.

The local fire-extinguishing system shall be provided with the following:

- An alarm located within the *galley* indicating operation of the local fire-extinguishing system.
- Clearly labelled remote controls located near the entrance to the *galley* for manually operating the local fire-extinguishing system.

In addition to the requirements of Clause 7.5.2.5, the exhaust duct shall be provided with a remotely operated *fire flap* in the upper end of the duct, and remote-control controls near the entrance to the *galley* for operating this *fire flap*.

Cooking appliances shall be provided with arrangements for automatically shutting off the electrical power or gas supply when the local fire-extinguishing system is activated.

NOTE: Local fire-extinguishing systems for cooking appliances are normally of the wet chemical type.

7.5.9 Additional requirement for deep fat cookers

Deep fat cookers shall be provided a primary and backup thermostat with an alarm to alert the operator in the event of failure of either thermostat.

CHAPTER 8 ACCOMMODATION SPACES

8.1 SCOPE

This Chapter lists requirements from Chapter 3 and Chapter 4 that are applicable to passenger and crew *Accommodation Spaces* (Clause 1.8) and specifies particular requirements that are additional to or modify the general requirements in Chapter 3 and Chapter 4.

8.2 GENERAL REQUIREMENTS APPLICABLE TO ACCOMMODATION SPACES

Accommodation Spaces shall comply with the clauses in Chapter 3 and Chapter 4 specified in Table 46.

Table 46 — General deemed-to-satisfy provisions applicable to *Accommodation Spaces*

Clause	Subject
Clause 3.3	Engine exhausts, boiler and galley uptakes
Clause 3.4	Certain highly flammable materials prohibited
Clause 3.5	Insulation
Clause 3.6	Paints, varnishes & other finishes on passenger vessels
Clause 3.7	Structural fire protection
Clause 3.7.4	Combustible veneers
Clause 4.2	Remote stops for ventilation and exhaust fans
Clause 4.3	Ventilation closing appliances
Clause 4.4	Centralised fire control functions on passenger vessels
Clause 4.5	Fire detection and fire alarm system
Clause 4.6	Emergency escape breathing devices
Clause 4.7.5	Fire main and hydrants for fire hose appliances
Clause 4.7.6	Fire hoses and nozzles
Clause 4.9	Fixed
Clause 4.10	Portable and wheeled fire extinguishers

PREVENTION OF FIRE

8.3 SMOKING

For the purposes of this standard, smoking shall be prohibited in *Accommodation Spaces* for berthed persons. Adequate non-smoking notices shall be displayed in compartments where smoking is not allowed.

Suitable *non-combustible* ash containers shall be provided in compartments where smoking is allowed.

8.4 HEATING APPLIANCES

Electric radiators or other heating appliances, if used, shall be fixed in position and so constructed as to reduce fire risks to a minimum. No heater shall be fitted with an exposed element or flame.

8.5 WASTE RECEPTACLES

Waste receptacles shall be constructed of *non-combustible* materials with no openings in the sides or bottom.

Table 47 — Fire-restricting materials

Space without aqueous fixed fire-extinguishing system	Fire Risk Category I	Fire Risk Category II	Fire Risk Category III	Fire Risk Category IV
Space with aqueous fixed fire-extinguishing system	Fire Risk Category I or II (1)	Fire Risk Category III (1)	Fire Risk Category IV	
Linings and ceilings	Clause 3.4	Group 1, 2 or 3	Group 1 or 2	Group 1 or <i>non-combustible</i> or FTP Code (2)
Furniture	Clause 3.4	Clause 3.4	Clause 3.4	Required
Draperies & curtains	Clause 3.4	Clause 3.4	Clause 3.4	Required
Upholstery	Clause 3.4	Clause 3.4	Clause 3.4	Required
Bedding	Clause 3.4	Clause 3.4	Clause 3.4	Required
Deck finish materials	Clause 3.4	Level 1, 2 or 3	Level 1 or 2	Level 1 or <i>non-combustible</i> or FTP Code (2)

KEY:

Group 1, Group 2 and Group 3 refer to materials that comply with specified standards for ceilings and linings contained in the Building Code of Australia; see Chapter 12.

Level 1, Level 2 and Level 3 refer to materials that comply with specified standards for floor coverings specified in the Building Code of Australia; see Chapter 12.

FTP Code: Refers to materials that comply with the Fire Test Procedures Code, see Chapter 12.

Applies refers to furniture, upholstery and bedding that comply with Chapter 12.

Clause 3.4: No specific requirement other than compliance with Clause 3.4.

(2) The fitting of an aqueous *fixed fire-extinguishing system* is not required under Clause 8.20 on vessels of *Fire Risk Category* I, II or III. However, optional fitting of such systems allows a reduction in *fire-restricting materials* on vessels of *Fire Risk Category* II and III.

(3) See also Clause 3.6.

FIRE GROWTH POTENTIAL

8.6 ADDITIONAL RESTRICTIONS ON THE USE OF COMBUSTIBLE MATERIALS

8.6.1 Fire-restricting materials

Ceilings and linings, furniture, draperies and curtains, upholstery, bedding and deck finish materials within *Accommodation Spaces* shall be of *fire-restricting materials* complying with Table 47. On vessels of *Fire Risk Category II* or *III* where an aqueous *fixed fire-extinguishing system* has been fitted as an option to protect the accommodation space, the requirements on the use of fire restricting materials may be reduced (Table 47).

8.6.2 Exposed surfaces in Accommodation Spaces

8.6.2.1 Combustible bulkheads, deckheads or decks

Where *fire-restricting materials* are specified in Table 47, exposed portions of combustible bulkheads, deckheads or decks in *Accommodation Spaces* that are not constructed of *fire-restricting materials*, including any partial bulkheads or decks, shall be enclosed with linings, ceiling or floor coverings as applicable complying with the applicable standards in Clause 8.6.1 and Chapter 12.

8.6.2.2 Doors not passing through fire-resisting divisions

8.6.2.2.1 Construction

Doors in *Accommodation Spaces* not passing through *fire-resisting divisions* shall be constructed from material of equivalent fire characteristics to the linings of the bulkhead specified in Table 47 through which they pass.

8.6.2.2.2 Ventilation openings

Ventilation openings may be included in the lower portion of doors not passing through *fire-resisting divisions*. The total net area of any such opening or openings shall not exceed 0.05 m² and shall be fitted with a grille of *non-combustible* material.

8.6.3 Facings, mouldings, decorations and veneers

8.6.3.1 Combustible veneers permitted

On vessels other than *Fire Risk Category I*, *Accommodation Spaces* with bulkheads and ceilings that are required by Table 8, Table 9 or Clause 8.12 to be *fire-resisting divisions* or of *non-combustible* materials may be faced with *combustible materials*, facings, mouldings, decorations and veneers.

These facings, mouldings, decorations and veneers shall—

- a) have a calorific value⁶ not exceeding 45 MJ/m² of the area for the thickness used; and

⁶ * Refer to the recommendations published by the International Organization for Standardization, in particular, Publication ISO 1716:1973 on *Determination of calorific potential*.

- b) not have a total volume exceeding the volume equivalent to a 2.5 mm veneer on the combined area of the walls and ceiling. This provision does not apply if the space is fitted with a *fixed fire-extinguishing system* complying with Clause 8.20.

NOTE: The requirements of this paragraph do not apply to furniture fixed to linings or bulkheads.

8.7 OIL PIPING IN ACCOMMODATION SPACES

Pipes conveying oil or other *combustible liquids* through *Accommodation Spaces* shall be of a material, or otherwise arranged, to ensure that their integrity is unaffected by fire within the accommodation space.

8.8 GROUPING OF MEANS FOR CONTROLLING POWER VENTILATION

In vessels of *Fire Risk Category* III and IV, power ventilation for *Accommodation Spaces* shall be fitted with controls grouped so that all fans within a space may be stopped from either of two separate positions. These positions shall be situated as far apart as practicable.

CONTROL OF SMOKE SPREAD

8.9 SMOKE ZONES

Where specified in Table 48, *Accommodation Spaces* on Class 1 passenger vessels shall be divided by *smoke-tight* divisions into at least two smoke zones.

Table 48 — Smoke zones and alternative safe areas on Class 1 passenger vessels

Day passengers	≤ 200	> 200 and ≤ 450	> 450 and ≤ 800	> 800
Berthed passengers		> 12 and ≤ 36	> 36	
<i>Fire Risk Category</i> I	Not required	No application	No application	No application
<i>Fire Risk Category</i> II	Not required	Smoke or ASA or FFE	No application	No application
<i>Fire Risk Category</i> III	Not required	Smoke or ASA or FFE	Smoke or ASA or FFE	Smoke and ASA, or FFE
<i>Fire Risk Category</i> IV	Not required	Smoke or ASA (1) (2)	Smoke and ASA (1) (2)	Smoke and ASA (1)

KEY:

No application: means that the number of passengers falls outside the definition of the particular *Fire Risk Category*.

Smoke: means the vessel shall have smoke zones complying with Clause 8.9.

ASA: means the vessel shall have an alternative safe area complying with Clause 8.13.

FFE: means the *Accommodation Spaces* may, as an alternative to smoke zones and/or alternative safe areas, be protected by an aqueous *fixed fire-extinguishing system* complying with Clause 8.20.

(1) FFE is required if more than 200 day passengers or more than 36 berthed passengers, see Clause 8.20.

(2) FFE is also an option to smoke zones or alternative safe areas if 200 day passengers or less and 36 berthed passengers or less.

Smoke zones shall comply with the following:

- a) The mean length of each zone shall not exceed 40 m.
- b) Divisions separating smoke zones shall—
 - i) be *smoke-tight*,
 - ii) be constructed of *non-combustible* or *fire-restricting materials* complying with Clause 8.6; and
 - iii) extend from deck to deck.

NOTE: Smoke zones may also be required to serve as alternative safe areas, see Clause 8.12 below.

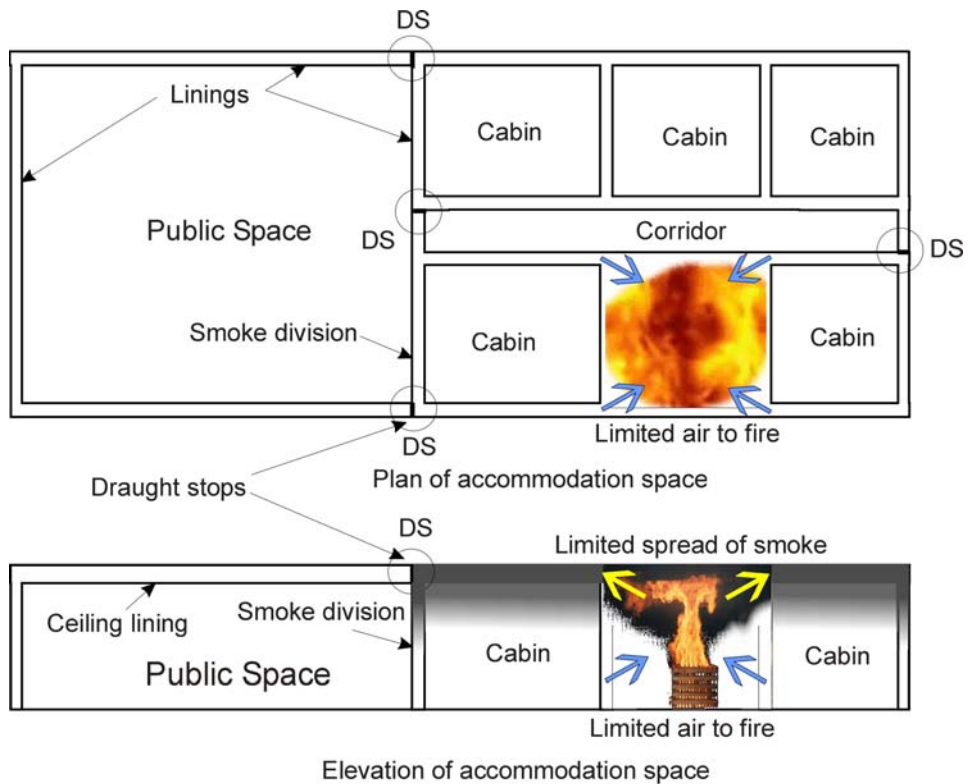

a) Illustration showing function of draught stops

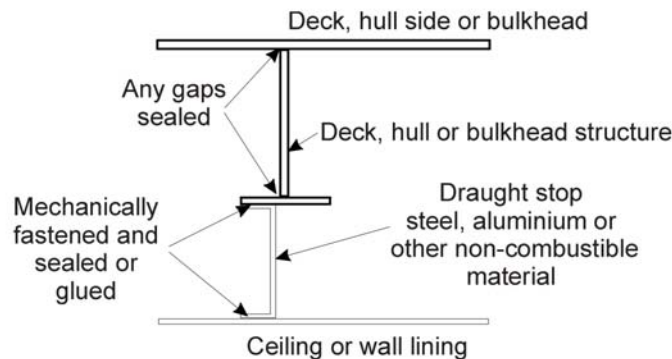

b) Typical detail of draught stop

Figure 7 — Draught stops

8.10 DRAUGHT STOPS

Where required in Table 49, air spaces enclosed behind ceilings, panelling or linings shall be divided by close-fitting draught stops spaced not more than 14 m apart. Vertically, such enclosed air spaces, including those behind linings of stairways and trunks shall be closed at each deck. See Figure 7.

Table 49 — Draught stops in Accommodation Spaces

Category	Application
Fire Risk Category I	Not required
Fire Risk Category II	Required if smoke zones in Clause 8.9 fitted
Fire Risk Category III	Required if smoke zones in Clause 8.9 fitted
Fire Risk Category IV	Required

8.11 SMOKE EXTRACTION SYSTEMS IN ATRIUMS OF PASSENGER VESSELS

Atriums shall be equipped with a smoke extraction system. The smoke extraction system shall be activated by the required smoke detection system and be capable of manual control. The fans shall be sized such that the entire volume within the space can be exhausted in 10 minutes or less.

MEANS OF ESCAPE

8.12 BLIND CORRIDORS

Where the total length of any blind corridor, including any stairway, exceeds 5 m the corridor bulkheads, doors opening on to the corridor and stairway bulkheads shall be of *non-combustible* material.

NOTE: Refer to Part C Section 1—*Arrangement, accommodation and personal safety* for details of the location and size of exits from spaces.

8.13 ALTERNATIVE SAFE AREAS

Where specified in Table 48, Class 1 vessels shall have a minimum of two safe areas to provide for the alternative assembly of passengers and crew should smoke enter or be generated within any part of the *Accommodation Space*. Safe areas shall comply with the following:

- a) A safe area shall be—
 - i) one of two or more smoke zones complying with Clause 8.9;
 - ii) a passenger space separated from other safe areas by *smoke-tight* or *fire-resisting divisions*; or
 - iii) an open space on deck that does not expose persons to other hazards.

NOTE: The exposed bow area of a seagoing vessel may not provide a suitable alternative safe area.

- b) The capacity of a safe area shall be determined by allowing for one person for each seat within the space and 0.35 m² per person of the net remaining deck area.

- c) The total capacity of safe areas on the vessel shall be sufficient to accommodate the maximum number of persons carried on the vessel assuming any one area of the *Accommodation Space* is rendered unusable in an emergency.
- d) A safe area shall be, as far as practicable, located adjacent to the smoke zone or *Accommodation Space* it is intended to serve. There shall be at least two exits from each smoke zone or *Accommodation Space*, located as far away from each other as possible, leading to the safe area.
- e) Each safe area shall incorporate evacuation routes to survival craft to enable all passengers and crew to be safely evacuated.

8.14 INTERNAL STAIRWAYS

8.14.1 Application

Table 50 specifies enclosures required on internal stairways between accommodation decks. These enclosures shall prevent the passage of smoke between decks and facilitate the escape and evacuation of persons.

NOTE: Refer also to Chapter 11 for fire safety measures applicable to *Escape or Evacuation Routes*.

Table 50 — Fire and smoke integrity of internal stairways

Category	2 decks	3 or more decks (A)
	Clause 8.14.2	Clause 8.14.3
<i>Fire Risk Category I</i>	Not required	Not required
<i>Fire Risk Category II</i>	Required (B)	Required
<i>Fire Risk Category III</i>	Required	Required
<i>Fire Risk Category IV</i>	Required	Required

KEY:

(A) Includes open decks intended for more than 36 passengers that lie above the accommodation deck.

(B) To the extent required to satisfy Clauses 8.9 and 8.13.

8.14.2 Two decks of accommodation

8.14.2.1 Stairways generally

Subject to Clause 8.14.2.2, internal stairways that serve only two decks of accommodation shall be enclosed on at least one level with a *smoke-tight* division of *non-combustible* or *fire-restricting materials*, see Figure 8. Where one or both of the decks contain accommodation for berthed passengers, the doors shall be self-closing.

NOTE: Option 1 is preferable to option 2 because the enclosure does not trap smoke, reducing the potential for exposure of persons to smoke. Hence, option 1 provides the better solution where there is no alternative route for escape other than through the smoke filled lower level.

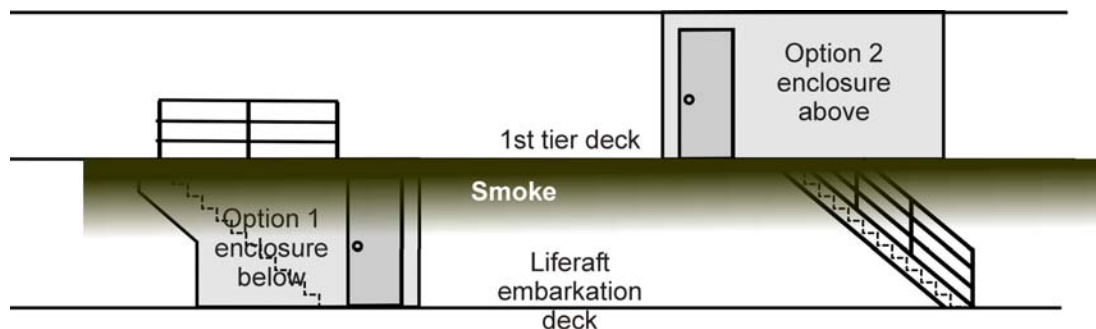

Figure 8 — Stairs penetrating 2 decks

8.14.2.2 Stairways in public spaces

Unless required to be *smoke-tight* to comply with Clauses 8.9 and 8.13, internal stairways that serve only two decks of accommodation may be fitted in the open in a *public space*, provided they lie wholly within the *public space* and the *public space* is provided with smoke detectors complying with Clause 8.15.2.

8.14.3 Three or more decks of accommodation

Where a vessel has three or more decks of accommodation, arrangements shall be provided to permit the escape of persons past a smoke filled intermediate deck if this path is required for evacuation into survival craft. An open deck above enclosed accommodation that is capable of accommodating more than 36 passengers shall be considered a deck of accommodation for the purposes of this Clause.

EXAMPLES:

- An enclosed stairway tower of the type described in Clause 11.6, see .
- External stairs complying with Clause 11.7.

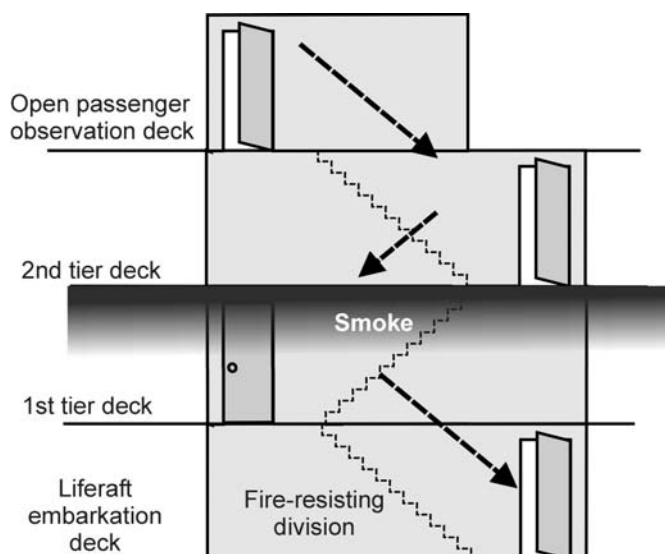

Figure 9— Stairway tower penetrating 3 or more decks

DETECTION AND ALARM

8.15 SMOKE DETECTORS IN ACCOMMODATION SPACES

8.15.1 Application

Smoke detectors complying with either Clauses 8.15.2 or 8.15.3 shall be fitted in *Accommodation Spaces* on vessels with accommodation for more than 4 berths or certified to carry more than 36 day passengers.

NOTE: Smoke detectors may be an integrated part of a *fixed fire detection and fire alarm system* or self-contained *smoke alarms*. Clauses 8.15.2 and 8.15.3 limit the use of self-contained *smoke alarms* to lower fire risk vessels.

8.15.2 Fixed fire detection and fire alarm system

A *fixed fire detection and fire alarm system* complying with Chapter 12 shall be installed to provide smoke detection in *Accommodation Spaces* on vessels specified in Table 51. Smoke detectors need not be fitted in spaces having little or no fire risk such as private bathrooms and public toilets lined with *non-combustible* materials.

NOTE: The installation of special purpose smoke detectors within ventilation ducting may provide an equivalent solution to fitting detectors within the space.

Table 51 — Fixed fire detection and fire alarm systems and manual call points in Accommodation Spaces

Category	Application
<i>Fire Risk Category I</i>	Not required
<i>Fire Risk Category II</i>	Required on vessels carrying more than 200 passengers (1)
<i>Fire Risk Category III</i>	Required
<i>Fire Risk Category IV</i>	Required

KEY:
(1) Also applies to a public space comprising 2 enclosed decks connected by an open stairway, see Clause 8.14.2.2.

8.15.3 Self contained smoke alarm

8.15.3.1 Specification

On vessels specified in Clause 8.15.1 that are not fitted with a fixed fire detection and fire alarm system, self contained photo-optical smoke alarms complying with AS 3786 and connected to a reliable power source shall be installed in each *Accommodation Space*.

NOTE: Reliable power supply means a power supply not relying solely on a self-contained dry cell battery. A self-contained dry cell battery may provide the emergency power to maintain the function of the detector in the absence of another emergency source of power.

8.15.3.2 Number and location

Smoke alarms shall be located—

- a) in accordance with the manufacturer's recommendations;
- b) on or near the ceiling of each deck of accommodation;

- c) between each area containing cabins or berths and the remainder of the vessel, or in the connecting corridor forming the means of escape from cabins;
- d) where cabins are not grouped in a common area or no connecting corridor exists, then an alarm shall be located within 1.5 m of the entrance to each cabin; and
- e) in enclosed portions of the path of travel persons must take to evacuate the vessel.

8.16 MANUALLY OPERATED CALL POINTS

Manually operated call points complying with Chapter 12 shall be installed throughout the *Accommodation Spaces* on those vessels specified in Table 51.

One manually operated call point shall be located at each exit from *Accommodation Spaces*. Manually operated call points shall be—

- a) readily accessible in the corridors and *public spaces* of each deck; and
- b) located so that no part of the corridor or space is more than 20 m walking distance from a manually operated call point.

8.17 INSPECTION HATCHES

On vessels of *Fire Risk Category IV* carrying more than 36 berthed passengers, the ceilings and linings shall incorporate inspection hatches or other means to enable inspection of concealed and inaccessible places. Inspection hatches are not required in locations where there is no risk of fire originating. The hatches or other means of inspection shall not impair the efficiency of the fire protection.

NOTE: For vessels carrying more than 36 berthed passengers, the requirements of this Section have been developed on the assumption that an efficient patrol system will be maintained so that an outbreak of fire may be promptly detected. Compliance with this Clause enables the fire patrol to investigate any smoke originating in concealed and inaccessible places.

FIRE FIGHTING

8.18 FIRE HOSE APPLIANCES

8.18.1 Minimum required flow at hydrants in Accommodation Spaces

The minimum flow rate of each fire hose appliance jet within *Accommodation Spaces* need not exceed that in Table 17 for single orifice nozzles of 12 mm diameter. Larger sizes of nozzle may be used in *Accommodation Spaces* where the layout and contents of the space would permit ready and effective use of a larger fire hose in emergency situations.

8.18.2 Fire hose reels

Fire hose reels complying with Chapter 12 that are incorporated into the fire main and are additional to hydrants may be substituted for fire hoses within *Accommodation Spaces* provided the hydrant pressure provided by

the fire main is not less than the minimum required for correct operation of the fire hose reel.

NOTE: The throw and flow performance of fire hose reels is less than that of a 12 mm diameter single orifice nozzle. However, fire hose reels provide a ready and effective means to fight fire that can still be supplemented by normal fire hoses connected to fire hydrants within *Accommodation Spaces* should the need arise.

8.19 PORTABLE FIRE EXTINGUISHERS

8.19.1 Number and type of fire extinguishers

Accommodation Spaces shall be provided with portable fire extinguishers of a type appropriate to the potential fire hazards within the space. The number of fire extinguishers in *Accommodation Spaces* shall be in accordance with Table 52. Where two extinguishers are to be provided in an enclosed *Accommodation Space* above the bulkhead deck, one extinguisher shall be available for use on each side of the vessel.

Table 52 — Portable fire extinguishers for *Accommodation Spaces*

Category	Number of fire extinguishers per space (A)
<i>Fire Risk Category I</i>	1
<i>Fire Risk Category II</i>	2
<i>Fire Risk Category III</i>	2
<i>Fire Risk Category IV</i>	2

KEY:

(A) For the purposes of this table, decks, watertight bulkheads, or smoke zones or a combination of these are considered to form the boundaries of an *Accommodation Space*.

8.19.2 Carbon dioxide fire extinguishers

Carbon dioxide fire extinguishers shall not be placed in *Accommodation Spaces* containing berthed accommodation.

8.20 AQUEOUS FIXED FIRE-EXTINGUISHING SYSTEMS

8.20.1 Application

Crew and passenger *Accommodation Spaces* on *Fire Risk Category IV* vessels carrying more than 200 day passengers or more than 36 berthed passengers shall be fitted with an aqueous *fixed fire-extinguishing system* in accordance with Table 53. The *fixed fire-extinguishing system* shall comply with MSC Resolution MSC.44(65), Clause 4.9 and Chapter 12. *Accommodation Spaces* having little or no fire risk such as voids and public toilets need not be fitted with a *fixed fire-extinguishing system*. Where a *fixed fire-extinguishing system* is fitted in a space containing a suspended ceiling, the fire extinguishing system shall protect the area above the suspended ceiling.

NOTE: While not required on vessels of *Fire Risk Category II* or *III* and some vessels of *Fire Risk Category IV*, the optional fitting of an aqueous *fixed fire-extinguishing system* in *Accommodation Spaces* allows a reduction in the requirements for *fire-restricting materials* within those spaces under Clause 8.6 or provides alternatives to the provision of smoke zones or alternative safe areas under Clauses 8.9 and 8.13.

Table 53 — Aqueous fixed fire-extinguishing systems for Accommodation Spaces on Fire Risk Category IV vessels

	Class A, B		Class C, D, E	
Day passengers	≤ 200 passengers Not required	> 200 passengers Required manual or automatic	≤ 200 passengers No application	> 200 passengers Not required
Berthed passengers	≤ 36 passengers Not required	> 36 passengers No application	≤ 36 passengers No application	> 36 passengers Required automatic

8.20.2 Automatic activation

Where specified in Table 53, the *fixed fire-extinguishing system* shall be arranged for automatic activation.

8.20.3 Manual activation

Where permitted in Table 53, manually operated *fixed fire-extinguishing systems* shall be divided into sections to limit the quantity of water being discharged at any one time while at the same time providing sufficient water to extinguish the likely fire hazard. Sections and pumps shall comply with MSC Resolution MSC 44(65). The valves for each section, start of pumps, and alarms shall be capable of being operated from two spaces separated as widely as possible, one of which shall be the continuously manned *Control Station* specified in Clause 4.4.

NOTE: Manually operated aqueous *fixed fire-extinguishing systems* are not as effective as automatically operated systems because automatic systems tend to operate more quickly and operate in a manner better targeted to the source and extent of fire.

CHAPTER 9 MINOR FIRE RISK SPACES

9.1 SCOPE

This Chapter lists requirements from Chapter 3 and Chapter 4 that are applicable to *Minor Fire Risk Spaces* and specifies particular requirements that are additional to or modify the general requirements applicable to vessels in Chapter 3 and Chapter 4.

9.2 APPLICATION

This Chapter applies to spaces in vessels defined by Clause 1.8 as being *Minor Fire Risk Spaces*.

9.3 GENERAL REQUIREMENTS APPLICABLE TO MINOR FIRE RISK SPACES

Minor Fire Risk Spaces shall comply with the clauses in Chapter 3 and Chapter 4 specified in Table 54

Table 54 — General deemed-to-satisfy provisions applicable to spaces of minor fire risk

Clause	Subject
Clause 3.2	Storage of combustible or flammable oils (including diesel fuel tanks)
Clause 3.3	Engine exhausts, boiler and galley uptakes
Clause 3.4	Certain highly flammable materials prohibited
Clause 3.5	Insulation
Clause 3.7	Structural fire protection
Clause 3.7.4	Combustible veneers
Clause 4.2	Remote stops for ventilation and exhaust fans
Clause 4.3	Ventilation closing appliances
Clause 4.4	Centralised fire control functions on passenger vessels
Clause 4.5	Fire detection and fire alarm system
Clause 4.7.5	Fire main and hydrants for fire hose appliances
Clause 4.7.6	Fire hoses and nozzles
Clause 4.9	Fixed fire-extinguishing systems

9.4 CARGO SPACES

9.4.1 Application

Clause 9.4 applies to cargo spaces that are not *Ro-Ro spaces* or do not contain *dangerous goods*.

NOTE: Cargo spaces that are *Ro-Ro spaces* or contain *dangerous goods* are classified as *High Fire Risk Spaces*; refer to Chapter 6.

CONTAINMENT OF FIRE

9.4.2 Separation of ventilation systems

The ventilation systems for cargo spaces shall be separated from each other and from the ventilation systems serving other spaces.

9.4.3 Closing down and sealing of cargo spaces

Vessels specified in Table 55 shall be provided with effective means for closing all ventilators and other openings leading to the cargo spaces.

NOTE: Refer also to NSCV Part C Section 2: Watertight and Weathertight Integrity for additional requirements pertaining to weathertight integrity of openings to cargo spaces.

9.4.4 Hatch covers

Cargo spaces on vessels specified in Table 55 shall be provided with hatch covers of steel or equivalent material.

Table 55 — Closing appliances for cargo spaces for fire safety (1)

Categories	Sealing of cargo spaces	Steel or equivalent hatch covers
<i>Fire Risk Category I</i>	Required (2)	Not required
<i>Fire Risk Category II</i>	Required (2)	Required (2)
<i>Fire Risk Category III</i>	Required	Required
<i>Fire Risk Category IV</i>	Required	Required

KEY:

(1) Refer to Part C Section 2: Watertight and weathertight integrity for additional requirements pertaining to weathertight integrity.

(2) Does not apply to *low risk cargo spaces*.

Table 56 — Fixed fire detection and fire alarm system in cargo spaces of Class 1 vessels

<i>Fire Risk Category</i>	<i>Closed vehicle spaces (1)</i>	<i>Other cargo spaces excepting low risk cargo spaces (2)</i>
<i>Fire Risk Category I</i>	Required	Not required
<i>Fire Risk Category II</i>	Required	Not required
<i>Fire Risk Category III</i>	Required	Required
<i>Fire Risk Category IV</i>	Required	Required

KEY:

(1) Refer to definition of *closed vehicle space* in Clause 1.4. For *Ro-Ro spaces*, see Clause 6.6.

(2) Refer to definition of *low risk cargo spaces* in Clause 1.5.

DETECTION AND ALARM

9.4.5 Fixed fire detection and fire alarm system

On Class 1 vessels specified in

Table 56, a *fixed fire detection and fire alarm system* or a sample extraction smoke detection system shall be provided in any cargo space. This provision does not apply to *low risk cargo spaces* or stowage spaces for luggage, provided that the latter is readily accessible for inspection at all times.

FIRE FIGHTING

9.4.6 Fixed fire-extinguishing systems for cargo spaces

9.4.6.1 Application

Cargo spaces, other than *low risk cargo spaces*, on vessels specified in Table 57 shall be protected by either—

- a) a manually operated carbon dioxide or inert gas *fixed fire-extinguishing system* complying with Clause 4.9 and Chapter 12; or
- b) another type of *fixed fire-extinguishing system* that gives equivalent protection.

The supply of extinguishing medium that serves the cargo spaces may also be used to protect machinery spaces provided—

- a) the extinguishing medium is suited for use in a machinery space;
- b) the performance of the *fixed fire-extinguishing systems* is not reduced;
- c) the system has the necessary isolating valves to properly regulate the quantity of medium discharged into each particular space; and
- d) there is sufficient quantity of extinguishing medium for at least one discharge in any one space served.

Table 57 — Fixed fire-extinguishing systems for cargo spaces on vessels

Fire category	Closed vehicle spaces (1)	Other cargo spaces (2) excepting low risk cargo spaces (3)
Fire category I	Required	Not required
Fire category II	Required	Required if measured length ≥ 55 m
Fire category III	Required	Required if measured length ≥ 55 m
Fire category IV	Required	Required if measured length ≥ 45 m

KEY:

(1) Refer to the definition of *closed vehicle space* in Clause 1.4. For *Ro-Ro spaces*, see Clause 6.6.

(2) A fixed gas fire-extinguishing system is ineffective on coal cargoes.

(3) Refer to definition of *low risk cargo spaces* in Clause 1.4.

9.4.6.2 Carbon-dioxide fixed fire-extinguishing systems

For cargo spaces, the quantity of carbon dioxide available shall be sufficient to give a minimum volume of free gas equal to 30% of the gross volume of the largest cargo space so protected in the vessel.

9.4.7 Low risk cargo spaces

The Certificate of Survey issued to a Class 2 vessel with cargo spaces classified as *low risk cargo spaces* shall list the cargoes the vessel is permitted to carry in those spaces.

CHAPTER 10 CONTROL STATIONS

10.1 SCOPE

This Chapter lists requirements from Chapter 3 and Chapter 4 that are applicable to *Control Stations* and specifies particular requirements that are additional to or modify the general requirements applicable to vessels in Chapter 3 and Chapter 4.

10.2 APPLICATION

This Chapter applies to spaces in vessels defined by Clause 1.8 as being *Control Stations*.

10.3 GENERAL REQUIREMENTS APPLICABLE TO CONTROL STATIONS

Control Stations shall comply with the clauses in Chapter 3 and Chapter 4 specified in Table 58.

Table 58 — General deemed-to-satisfy provisions applicable to *Control Stations*

Clause	Subject
Clause 3.3	Engine exhausts, boiler and galley uptakes
Clause 3.4	Certain highly flammable materials prohibited
Clause 3.5	Insulation
Clause 3.6	Paints, varnishes & other finishes on passenger vessels
Clause 3.7	Structural fire protection
Clause 3.7.4	Combustible veneers
Clause 3.9	Maintenance of structural integrity
Clause 4.3	Ventilation closing appliances
Clause 4.4	Centralised fire control functions on passenger vessels
Clause 4.5	Fire detection and fire alarm system
Clause 4.7.5	Fire main and hydrants for fire hose appliances
Clause 4.7.6	Fire hoses and nozzles
Clause 4.9	Fixed fire-extinguishing systems
Clause 4.10	Portable and wheeled fire extinguishers

FIRE GROWTH POTENTIAL

10.4 EXPOSED SURFACES

Linings, ceilings and deck finish materials in *Control Stations* shall be faced with *fire-restricting materials* complying with Table 47.

10.5 CONCEALED OR INACCESSIBLE SPACES

Surfaces and grounds in concealed or inaccessible spaces adjacent to electrical or other fire hazards in *Control Stations* shall be faced with *low flame spread* materials that comply with Chapter 12.

CONTROL OF SMOKE SPREAD

10.6 VENTILATION OF CONTROL STATIONS

The ventilation of *Control Stations* on vessels shall be such that, in the event of fire, personnel can continue to carry out essential safety functions within the *Control Station*. The ventilation of *Control Stations* shall be separate from the ventilation of spaces required to have *smoke-tight* divisions (including *fire-resisting divisions*) in Table 7, Table 8 and Table 9. For *Control Stations* not opening to open decks, two separate air supplies shall be provided. The air inlets of the two sources of supply shall be positioned so that the risk of both inlets drawing in smoke simultaneously is minimised.

NOTE: This clause effectively requires the *operating compartment* to be separated from the *Accommodation Space*.

DETECTION AND ALARM

10.7 SMOKE DETECTORS IN CONTROL STATIONS

On vessels specified in Table 59, *Control Stations* containing electrical equipment and other potential sources of fire shall be provided with smoke detectors integrated into a *fixed fire detection and fire alarm system*. Smoke detectors shall be installed to provide effective smoke detection within the whole *Control Station*. Smoke detectors need not be fitted in control stations having little or no fire risk such as carbon dioxide rooms.

Table 59 — Requirement for smoke detectors and manually operated call points in *Control Stations*

Category	Smoke detectors	Manually operated call points
<i>Fire Risk Category I</i>	Not required	Not required
<i>Fire Risk Category II</i>	Required if >200 passengers	Required if > 200 passengers (1)
<i>Fire Risk Category III</i>	Required	Required (1)
<i>Fire Risk Category IV</i>	Required	Required (1)

KEY:

(1) Not required in the *operating compartment* where the fire detector control panel is located in the *operating compartment*.

10.8 MANUALLY OPERATED CALL POINTS

Control Stations on the vessels specified in Table 59 shall be fitted with manually operated call points complying with Chapter 12. Manually operated call points need not be provided in the *operating compartment* of

a vessel where the fire detector control panel is located within the *operating compartment*.

FIRE FIGHTING

10.9 PORTABLE FIRE EXTINGUISHERS

A portable fire extinguisher complying with Clause 4.10 shall be located in each *Control Station*. Vessels of *Fire Risk Category I* or *II* need not be fitted with this extinguisher provided that—

- a) there is at least one *Accommodation Space* or machinery space extinguisher located in close proximity to and visible from the *Control Station*; and
- b) the extinguisher in (a) is suited to the fire hazards likely to arise within the *Control Station*, see Clause 4.10.2.

CHAPTER 11 ESCAPE OR EVACUATION ROUTES

11.1 SCOPE

This Chapter lists requirements from Chapter 3 and Chapter 4 that are applicable to *Escape or Evacuation Routes* and specifies particular requirements that are additional to or modify the general requirements applicable to vessels in Chapter 3 and Chapter 4.

11.2 APPLICATION

This Chapter applies to spaces in vessels defined by Clause 1.8 as being *Escape or Evacuation Routes*.

NOTE: NSCV Part C Chapter 1: Arrangement, accommodation and personal safety contains requirements for escape or evacuation routes including the minimum width of corridors, stairways and stairway towers.

11.3 GENERAL REQUIREMENTS APPLICABLE TO ESCAPE OR EVACUATION ROUTES

Escape or Evacuation Routes shall comply with the clauses in Chapter 3 and Chapter 4 specified in Table 60.

Table 60 — General deemed-to-satisfy provisions applicable to *Escape or Evacuation Routes*

Clause	Subject
Clause 3.3	Engine exhausts, boiler and galley uptakes
Clause 3.4	Certain highly flammable materials prohibited
Clause 3.5	Insulation
Clause 3.6	Paints, varnishes & other finishes on passenger vessels
Clause 3.7	Structural fire protection
Clause 3.7.4	Combustible veneers
Clause 3.9	Maintenance of structural integrity
Clause 4.3	Ventilation closing appliances
Clause 4.4	Centralised fire control functions on passenger vessels
Clause 4.5	Fire detection and fire alarm system
Clause 4.7.5	Fire main and hydrants for fire hose appliances
Clause 4.7.6	Fire hoses and nozzles

FIRE GROWTH POTENTIAL

11.4 EXPOSED SURFACES IN CORRIDORS AND STAIRWAY ENCLOSURES

Linings, ceilings and deck finish materials in corridors and stairway enclosures shall be faced with *fire-restricting materials* complying with Table 47.

11.5 FURNITURE IN STAIRWAY ENCLOSURES

Furniture, if located in stairway enclosures on a Class 1 vessel, shall be of *fire-restricting materials* where specified in Table 47.

NOTE: Additional requirements limiting the use of furniture in stairway enclosures are listed in Part C Section 1: *Arrangement, accommodation and personal safety*.

ESCAPE AND EVACUATION

11.6 STAIRWAY TOWERS

11.6.1 Boundaries

Stairway towers (see Clause 8.14.3 and) that serve three or more decks of accommodation shall be enclosed at all levels by *fire-resisting divisions*. The *time rating* of such *fire-resisting divisions* shall be the applicable time specified in Table 7, Table 8 or Table 9 or 15 minutes, whichever is greater.

11.6.2 Doors

Doors to stairway towers shall be self-closing and shall comply with the requirements for penetrations through *fire-resisting divisions* specified in Clause 3.8 and Chapter 12. Where none of the decks served by the stairway tower contain accommodation for berthed persons, the self-closing doors may be arranged with catches to keep them open under normal conditions.

11.6.3 Limitations on spaces having access to stairway towers

Direct access to stairway towers shall be limited to the following spaces:

- a) *Public spaces*.
- b) Corridors.
- c) Lifts.
- d) Public toilets.
- e) *Special category spaces* and *open Ro-Ro spaces* to which passengers can have access.
- f) External areas.

11.6.4 Ventilation

On vessels of *Fire Risk Category* III and IV carrying more than 36 passengers, the ventilation of stairway towers shall be independent of the spaces they serve.

11.7 EXTERNAL OPEN STAIRWAYS

Boundaries facing external open stairways and passageways forming part of an escape route and boundaries in such a position that their failure during a fire would impede movement to the embarkation deck shall be *fire-resisting divisions* of *time rating* specified in Table 7, Table 8 or Table 9.

11.8 PROTECTION OF SURVIVAL CRAFT

Survival craft shall be protected from spaces of *High Fire Risk* or *Moderate Fire Risk* by *fire-resisting divisions* of *time rating* specified in Table 7, Table 8 or Table 9.

NOTE: Refer to Part C Section 7A for the definition of survival craft.

DETECTION AND ALARM**11.9 FIXED FIRE DETECTION AND FIRE ALARM SYSTEM**

On vessels specified in Table 61, a *fixed fire detection and fire alarm system* shall be installed and arranged to provide smoke detection in enclosed corridors, stairways and escape routes within *Accommodation Spaces*.

Table 61 — Fixed fire detection and fire alarm systems in enclosed corridors, stairways and escape routes

Category	Application
<i>Fire Risk Category I</i>	Not required
<i>Fire Risk Category II</i>	Required if a <i>fixed fire detection and fire alarm system</i> is specified under Clause 8.15.
<i>Fire Risk Category III</i>	Required
<i>Fire Risk Category IV</i>	Required

CHAPTER 12 FIRE PROTECTION MEASURES—DESIGN, CONSTRUCTION AND INSTALLATION

12.1 SCOPE

This Chapter specifies the requirements for the design, construction, testing and installation of components, systems and installations of *active* and *passive fire protection measures*.

12.2 OBJECTIVE

The objective of this Chapter is to ensure that the actual performance of *active* and *passive fire protection measures* on a vessel is no less than that intended for the fire safety solutions specified earlier within this Section.

REQUIRED OUTCOMES

12.3 TYPE

Components, systems and installations that comprise the *active* and *passive fire protection measures* on a vessel, including materials and *fire equipment*, must be of a type appropriate to control to acceptable levels the risks associated with potential or actual fire on the vessel.

12.4 PERFORMANCE

Each component and system of the *active* and *passive fire protection measures* must be designed, constructed and arranged to significantly enhance the probability of survival by —

- a) preventing the occurrence of fire;
- b) reducing the consequences in the event of a fire incident; or
- c) both a) and b).

12.5 SAFETY OF PERSONNEL

Each component and system of the *active* and *passive fire protection measures* must be designed, constructed and arranged to avoid unacceptable risks to personnel associated with their presence, intentional operation or accidental operation.

12.6 AVAILABILITY

All *fire equipment* must be readily available in the event of a fire incident.

12.7 RELIABILITY

All components, systems and installations of *active* and *passive fire protection measures* must be designed, constructed, arranged and maintained to function reliably at time of need.

12.8 OPERATING INSTRUCTIONS

Persons must have access to all relevant information that may be needed to prepare for and facilitate the effective use of all available *active* and *passive fire protection measures* in an emergency.

DEEMED-TO-SATISFY SOLUTIONS

12.9 COMPLIANCE

For the purpose of this Chapter, components, systems and installations of *active* and *passive fire protection measures* shall be deemed-to-satisfy the Required Outcomes in Clauses 12.3 to 12.8, if they comply with Clause 12.10.

NOTE: Products that meet the standards specified under Clause 12.10 may also be subject to provisions specified elsewhere in this Section. For example, specific clauses that do not permit the automatic activation of certain *fixed fire-extinguishing systems*.

12.10 STANDARDS FOR FIRE SAFETY MATERIALS AND EQUIPMENT

12.10.1 Specification

The components, systems and installations of *active* and *passive fire protection measures* specified in column 1 of Table 62 shall comply with the standards specified in column 2 of Table 62.

12.10.2 Assessment and verification

Each component, system or installation of *active* or *passive fire protection measures* shall be type assessed and verified as meeting the applicable standard or specification or test. To be deemed-to-satisfy this requirement they shall be—

- a) tested and specifically listed for the purpose specified in this Section by a recognised testing and listing Organisation in Australia, such as a NATA accredited laboratory, or a specialised laboratory such as the Scientific Service Laboratory (SSL);
- b) certified by a JAS-ANZ accredited product certification body;
- c) type approved by a ship classification society recognised by the Australian Maritime Safety Authority (AMSA); or
- d) certified by an AMSA-recognised Notified Body in accordance with the EU Marine Equipment Directive, Module B (MED-B).

NOTE: A listing of fire safety materials and equipment that has been verified as complying with the NSCV is available on the Register of Compliant Equipment published by the NMSC at www.nmsc.gov.au.

12.11 INSTALLATION AND TESTING

Components and systems of *active* and *passive fire protection measures* shall be installed on the vessel and tested by competent persons in accordance with specifications for installation that may form part of the standard specified in Table 62 and in relevant approval documentation arising from Clause 12.10.2.

NOTE: The installer may be required to supply an installation certificate following commissioning declaring that the installation meets the required standards for installation and testing.

Table 62 — Standards for components, systems and installations of active and passive fire protection measures

Item	Applicable deemed-to-satisfy standard (1)	References
Fire growth potential		
<i>Non-combustible material</i>	Fire Test Procedures Code—Part 1, or Annex D of this Section (Includes FTP Code Class B and C rated divisions)	1.5, 3.3, 3.5, 3.7.1(Table 9), 3.7.4, 6.3.3, 6.5.2.1, 6.7.2.1, 6.7.2.2, 7.3.2,7.5.2.4, 7.5.2.5, 8.3, 8.5, 8.6.1(Table 47), 8.6.2.2.2, 8.6.3.1, 8.9, 8.12, 8.14.2.1, 8.15.2
<i>Low flame spread surface</i>	Fire Test Procedures Code—Part 5, or Annex E of this Section	1.4, 3.5.2(Table 6), 3.7.4, 7.5.2.4, 7.5.2.5, 8.6.1 (Table 47), 10.5
<i>Fire-restricting materials — Bulkheads & Ceilings, Groups 1, 2 and 3</i>	Annex F of this Section (2)	1.5, 3.7.1(Table 9), 6.5.2.1, 8.6.1 (Table 47), 8.6.2.1, 8.6.2.2, 8.9, 8.13, 8.14.2.1, 10.4, 11.4
<i>Fire-restricting materials —Floor materials and floor coverings: Levels 1, 2 and 3.</i>	Annex G of this Section	1.4, 3.7.1 (Table 9), 8.6.1 (Table 47), 8.6.2.1, 8.9, 8.13, 8.14.2.1, 10.4, 11.4
<i>Fire-restricting materials —FTP Code bulkhead and ceilings</i>	Fire Test Procedures Code Part 2 (2)	1.4, 3.7.1 (Table 9), 6.5.2.1, 8.6.1 (Table 47), 8.6.2.1, 8.6.2.2, 8.9, 8.13, 8.14.2.1, 10.4, 11.4
<i>Fire-restricting materials —FTP Code deck finish materials</i>	Fire Test Procedures Code Part 2 and Part 6	1.4, 3.7.1 (Table 9), 6.5.2.1, 8.6.1 (Table 47), 8.6.2.1, 8.6.2.2, 8.9, 8.13, 8.14.2.1, 10.4, 11.4
<i>Fire-restricting materials — Furniture</i>	FTP Code Part 8 plus Annex H of this Section, or BS 7176 low hazard rating	8.6.1 (Table 47), 11.5
<i>Fire-restricting materials — Draperies & curtains</i>	FTP Code Part 7	8.6.1 (Table 47)
<i>Fire-restricting materials — Upholstery</i>	FTP Code Part 8	8.6.1 (Table 47)
<i>Fire-restricting materials — Bedding (3)</i>	FTP Code Part 9, or BS 7177 low hazard rating	8.6.1 (Table 47)
<i>Combustible sound or thermal insulation</i>	Annex I of this Section	3.5.2 (Table 6)

(Continued...)

Table 62 cont.

Item	Applicable deemed-to-satisfy standard (1)	References
Containment of fire		
<i>Fire-resisting divisions</i>	Class A divisions, Fire Test Procedures Code—Part 3 or HSC Code 7.2 and Fire Test Procedures Code—Resolution MSC45(65)	1.5, 3.7.1 (Table 7, Table 8, Table 9), 3.7.2, 3.7.3, 3.7.4, 6.4.11, 6.7.2.1, 8.6.3.1, 11.6.1, 11.7, 11.8
Doors penetrating <i>fire-resisting divisions</i>	Class A divisions, Fire Test Procedures Code—Part 3	3.8.6, 6.4.10, 6.5.4.3, 11.6.2
Self-closing doors	SOLAS Reg. 9 Clause 4.1.1.4	3.8.2, 3.8.6, 6.4.10, 6.5.4.3, 11.6.2
Pipe penetrations of <i>fire-resisting divisions</i>	Class A divisions, Fire Test Procedures Code—Part 3	3.8.2, 3.8.3
<i>Fire dampers and duct penetrations</i>	Class A divisions, Fire Test Procedures Code—Part 3	3.8.2, 3.8.5, 6.5.2.1,
Cable transits	Class A divisions, Fire Test Procedures Code—Part 3	3.8.2
Smoke generation potential and toxicity		
Smoke and toxicity	Fire Test Procedures Code—Part 2, or Fire Test Procedures Code—Annex 2	3.6
Structural integrity		
Standard fire test	Fire Test Procedures Code—Part 3	3.9
Detection and alarm		
<i>Fire detection and fire alarm system</i>	Fire Safety Systems Code—Chapter 9, or HSC Code Clause 7.7, or AS 1603	4.4, 4.5, 6.4.12, 6.5.6, 6.6.5 (Table 36), 6.8.6, 7.4.2, 8.15, 8.16, 9.4.5, 10.7, 11.9
Fire control and indicating equipment	SOLAS Regulation 6.9 HSC Code Clause 7.7 AS 1603 and AS 4428 component standards	4.4, 4.5, 6.4.12, 6.5.6, 6.5.6.2, 6.6.5 (Table 36), 6.8.6, 7.4.2, 8.15, 9.4.5, 10.7, 10.8, 11.9
Manually operated call points	AS 1603.5 component standards	6.5.6.2, 8.16, 10.8
<i>Fixed fire detection and fire alarm system including manually operated call points.</i>	Fire Safety Systems Code—Chapter 9, or AS 1670	4.4, 4.5, 6.4.12, 6.5.6, 6.5.6.2, 6.6.5 (Table 36), 6.8.6, 7.4.2, 8.15, 9.4.5, 10.7, 10.8, 11.9
Self-contained <i>smoke alarm</i>	AS 3786	8.15.3

(Continued...)

Table 62 cont.

Item	Applicable deemed-to-satisfy standard (1)	References
Means of escape		
Emergency escape breathing devices	Fire Safety Systems Code—Chapter 3, or AS 1716 where equivalent	4.6
Fire fighting		
Portable fire extinguishers	Fire Safety Systems Code—Chapter 4, or AS/NZS 1841 component standards	4.10, 6.4.14, 6.4.15, 6.4.16, 6.5.9, 6.6.5(Table 36), 6.7.8, 6.9.5.3, 7.3.3, 7.4.3.1, 7.5.7, 8.19, 10.9
<i>Foam making branch pipe</i>	Annex J of this Section Fire Safety Systems Code—Chapter 4 (Portable foam applicator unit)	1.4, 6.4.15, 6.5.9, 6.7.7
<i>Water fog applicator</i>	Clause 1.5	1.4, 6.5.9
Wheeled fire extinguishers	Marine Orders Part 15 Appendix 2, Clauses 1, 2 & 3, or AS 4265	4.10, 6.4.15, 6.7.8
<i>Gaseous fixed fire-extinguishing systems</i>	Fire Safety Systems Code—Chapter 5, or AS 4214	4.9, 6.4.11, 6.4.13, 6.6.5, 6.8.7, 9.4.6
<i>High-expansion foam fixed fire-extinguishing systems</i>	Fire Safety Systems Code—Chapter 6	4.9, 6.4.11, 6.4.13, 6.6.5, 6.8.7, 9.4.6
<i>Aerosol fixed fire-extinguishing systems</i>	IMO MSC/Circ.1007	4.9, 6.4.11, 6.4.13, 6.6.5, 6.8.7, 9.4.6
<i>Pressure water fixed fire-extinguishing systems (including automatic fire sprinkler systems)</i>	Fire Safety Systems Code—Chapter 7 & Chapter 8, or NFPA 15, or NFPA 750, or AS 2118, or AS 4587, or SP-method 2377	4.9, 6.4.11, 6.4.13, 6.5.7, 6.6.5, 6.8.7, 8.20, 9.4.6
<i>Dry chemical fixed fire-extinguishing systems</i>	NFPA 17	6.9.5.3
Galley automatic local fire extinguishing systems	UL 300 (4), or ISO 15371, or NFPA 17	7.5.8

(Continued...)

Table 62 cont.

Item	Applicable deemed-to-satisfy standard (1)	References
Fire-fighting (cont)		
Lay-flat fire hoses	AS 2792	4.7, 4.7.2, 4.7.6, 8.18.1
Fire hose reels	AS/NZS 1221	8.18.2
International shore connection	Figure 5 Fire Safety Systems Code— Chapter 2	4.7.5.9
Fire-fighters' outfits	Fire Safety Systems Code— Chapter 3	4.11, 6.7.9
Fire blankets	AS 3504 and AS 2444, or EN 1869 and relevant parts of AS 2444.	7.5.7

NOTES:

- (1) Where more than one standard is specified as applicable to an item of equipment or a component and there is nothing in other chapters that specifies otherwise, either standard may be used. There is no implication that the standards are fully equivalent.
- (2) The Room Corner Test is a large scale and expensive test. The Cone Calorimeter (ISO 5660) is a small-scale test method that may be used in lieu of the Room Corner Test for quality control and the testing of minor changes such as surface thickness, type and colour.
- (3) Bedding comprises blankets, quilts, bedspreads, pillows and mattresses, including thin, light mattresses used on top of other mattresses.
- (4) The UL 300 test specification has been prepared to accommodate the use of new vegetable oils with a high auto-ignition temperature.

CHAPTER 13 SERVICING OF FIRE EQUIPMENT

13.1 SCOPE

This Chapter specifies requirements for the servicing of *fire equipment*.

13.2 OBJECTIVE

The objective of this Chapter is to specify minimum standards for the servicing of *fire equipment* so that the effectiveness of these fire safety protection measures can be maintained.

NOTES:

1. The servicing of *fire equipment* effectively renews the reliability of the equipment until the next date of servicing, excluding any damage or tampering after servicing. Servicing also provides the opportunity for a delegated periodic survey inspection of the equipment on behalf of the Authority.
2. When procuring *fire equipment* that requires servicing, consideration should be given to the long-term availability and geographic proximity of persons or organisations competent and qualified to service the *fire equipment*.

REQUIRED OUTCOMES

13.3 MAINTENANCE OF FUNCTION

The effectiveness of all *fire equipment* must be maintained over the life of the vessel.

13.4 RELIABILITY

The reliability of items of *fire equipment* must not reduce over time.

13.5 QUALITY

Persons or organisations engaged in the servicing of *fire equipment* must establish and apply appropriate management processes to control the quality of servicing outcomes and allow these outcomes to be verified.

DEEMED-TO-SATISFY SOLUTIONS

13.6 COMPLIANCE

For the purpose of this National Standard, *fire equipment* shall be deemed-to-satisfy the Required Outcomes in Clauses 13.3 to 13.5, if it is serviced in accordance with Clause 13.7.

NOTE: An arrangement for the servicing of *fire equipment* that gives a servicing warranty provides evidence of compliance with the required outcomes.

13.7 SERVICING SCOPE AND FREQUENCY

Items of *fire equipment* shall be serviced in accordance with AS 1851.

Emergency escape breathing devices and breathing apparatus on fire-fighters' outfits shall be serviced in accordance with AS/NZS 1715.

13.8 COMPETENCE

Only competent persons or organisations shall undertake the servicing of fire safety equipment. Competence shall be relevant to the particular type of equipment. Competent persons or organisations shall be one of the following—

- a) Accredited or licensed by an appropriate Authority or fire administration within the jurisdiction;
- b) The manufacturer, an agent of the manufacturer or a service station approved by the manufacturer; or
- c) Accredited or licensed by a Classification Society.

NOTE: Subclause a) above provides that members of the vessel's crew may undertake servicing functions specified in AS 1851 to the extent that those functions fall within the crewmember's level of competence.

ANNEX A FIRE HAZARD ANALYSIS

A1 SCOPE

Annex A summarises the key fire hazards addressed by the provisions of this section and other sections of the NSCV. The table forms the basis for the requirements contained in this Section.

This informative Annex is referenced in Clause 1.6.4 of this Section.

Table A.1 – Fire hazard analysis

Hazard	Likelihood risk factor	Deemed-to-satisfy solutions	Consequence risk factor	Deemed-to-satisfy solutions
Collection of explosive or flammable vapours Petrol storage Petrol systems Petrol machinery Petrol cargo Gas storage Gas appliances Gas machinery Ro-Ro spaces Cargo spaces Battery compartments	Fuel type	Limitations on fuel types Packaging of <i>dangerous goods</i>	Proximity of ignition source	Prohibition on enclosed petrol motors Earthing of components Design of in-built petrol tanks Electrical equipment for use in hazardous areas
	Enclosed space	Location of portable petrol tanks Design of built-in petrol tanks Prohibition on enclosed petrol motors Storage of gas cylinders Ventilation Battery compartment design	Proximity of persons	Separation of spaces
	Leakage of flammable vapour	Piping design and construction Design of built-in petrol tanks Gas alarms Flame failure devices		

Table A1 cont.

Hazard	Likelihood risk factor	Deemed-to-satisfy solutions	Consequence risk factor	Deemed-to-satisfy solutions
Spillage or escape of combustible or flammable liquids Fuel Lubricating oil Cooking oil Hydraulic oil Other <i>flammable liquid</i> Oil cargo <i>Ro-Ro spaces</i>	Fuel type	Special requirements for below decks petrol tanks	Proximity of ignition sources	Location of tanks Design of petrol tanks Shielding Containment of fuel
	<i>Combustible or flammable liquids</i> under pressure	Mechanisms to avoid overpressure Pressure monitoring Limits on flexible piping Pipe & coupling design Filter design	Quantity of spilt or escaped <i>combustible or flammable liquids</i> (fluid pressure and pipe size)	Monitoring of pressures Early fire detection and extinguishing Remote shutoff of pumps, tanks, machinery, etc. Fire patrol or CCTV monitoring Early fire extinction
	Complexity of machinery	<i>Fire detection and fire alarm system</i> Fire extinguishing	Duration of fire	Shut down of space openings Early fire detection Early fire extinguishing
	Poor design	Design requirements for Tank construction & location Piping Filling & venting	Number of passengers	Emergency Plan <i>Fire detection and fire alarm system</i> Fire extinguishing
			Berthed passengers	<i>Fire detection and fire alarm system</i> Fire extinguishing Emergency Plan Marking of Escapes
			Time until rescue	<i>Fire detection and fire alarm system</i> Fire extinguishing Life saving equipment

(Continued...)

Table A1 cont.

Hazard	Likelihood risk factor	Deemed-to-satisfy solutions	Consequence risk factor	Deemed-to-satisfy solutions
Sources of heat or ignition Exhaust piping, <i>Galley</i> equipment, Electrical failures, Turbochargers Smoking Arson Lightning	Exposed flames	Prohibition on smoking Prohibition on exposed flames in spaces. Fire patrols Heat & smoke detectors Limits on the use of nitrocellulose	Proximity to combustible materials	Isolation of sources of heat in separate spaces; e.g. machinery spaces, <i>galleys</i> Use of <i>non-combustible</i> materials in immediate proximity to the hazard Limits on combustion characteristics of materials Insulation Structural fire protection Provisions for <i>dangerous goods</i>
	Electrical failure	Insulation Circuit breakers Cable cross-section Dry running pumps	Number of passengers	Early fire detection Early fire extinguishing Structural fire protection Emergency plan Marking of escapes Fire alarms
	Heat generated by machinery	Ventilation Temperature monitoring Insulation Water-cooled exhausts Shielding Heat & smoke detectors	Berthed passengers	Early fire detection Early fire extinguishing Structural fire protection Emergency plan Evacuation drills Marking of escapes Fire alarms
			Time until rescue	Early fire detection Fire suppression systems Structural fire protection Life saving equipment

(Continued...)

Table A1 cont.

Hazard	Likelihood risk factor	Deemed-to-satisfy solutions	Consequence risk factor	Deemed-to-satisfy solutions
Smoke & heat tolerance Smoke toxicity Smoke quantity Excessive temperature	Materials of construction	<i>Non-combustible</i> materials Limits on types of materials Linings	Duration of fire	Smoke & heat detection Fire patrols Fire extinguishing
	Materials for linings and furnishings	Standards for smoke developed, toxicity	Number of passengers	Alternative assembly areas Early fire detection Early fire extinguishing Structural fire protection Emergency plan Marking of escapes Fire alarms
	Likelihood of fire	Prohibition on smoking Prohibition on naked flames Fire patrols Limitations on ignitability Limitations on spread of fire Limitations on heat developed	Berthed passengers	Early fire detection Early fire extinguishing Structural fire protection Emergency plan Evacuation drills Marking of escapes Fire alarms
			Time until rescue	Early fire detection Fire suppression Structural fire protection Life saving equipment

(Continued...)

Table A1 cont.

Hazard	Likelihood risk factor	Deemed-to-satisfy solutions	Consequence risk factor	Deemed-to-satisfy solutions
Spread of fire Structural failure Transmission of fire Loss of secure space Forced evacuation	Material of construction	<i>Non-combustible</i> materials Structural fire protection	Duration of fire	Early detection Early extinction in space of origin
	Likelihood of fire	See Spillage & heat sources above	Temperature rise in adjacent space	Fire hydrant cooling
			Number of passengers	Alternative assembly areas Early fire detection Early fire extinguishing Fire suppression Structural fire protection Emergency plan Marking of escapes Fire alarms
			Berthed passengers	Early fire detection Early fire extinction Fire suppression Structural fire protection Emergency plan Evacuation drills Marking of escapes Fire alarms
			Time until rescue	Early fire detection Fire suppression Structural fire protection Life saving equipment

(Continued...)

Table A1 cont.

Hazard	Likelihood risk factor	Deemed-to-satisfy solutions	Consequence risk factor	Deemed-to-satisfy solutions
Fire-induced failure of essential systems Lifesaving Communications Electrical power Bilge pumping Fire fighting Watertight integrity	Likelihood of fire	See Spillage & heat sources above	Number of passengers	Redundancy of systems Protection of systems
	Proximity of systems	Isolation of <i>Control Stations</i> from areas of high risk Structural fire protection	Berthed passengers	Redundancy of systems Protection of systems
			Time until rescue	Redundancy of systems Protection of systems

ANNEX B EQUIVALENT SOLUTIONS FOR FIRE SAFETY SYSTEMS

B1 OBJECTIVE

The objective of this Annex is to provide a methodology for developing equivalent solutions for fire safety. It forms a normative part of this document.

This Annex is referenced in Clause 2.10 of this Section.

B2 GENERAL

Fire safety design and arrangements may deviate from the deemed-to-satisfy solution set out in Chapter 3 to Chapter 12, provided that the equivalent solution meets the required fire safety outcomes of Chapter 2.

B3 ASSESSMENT METHODS

Engineering analysis, evaluation and approval of the equivalent solution shall be carried out in accordance with this Annex.

B3.1 Engineering analysis

The engineering analysis shall be prepared and submitted for independent review by a competent organisation⁷, and shall include, as a minimum, the following elements:

- a) Description of the vessel type and space(s) concerned.
- b) Identification of deemed-to-satisfy requirement(s) with which the vessel or the space(s) will not comply.
- c) Identification of the fire and explosion hazards of the vessel or the space(s) concerned, including:
 - i) Identification of the possible ignition sources.
 - ii) Identification of the fuel loading for each space concerned.
 - iii) Identification of the fire growth potential of each space concerned.
 - iv) Identification of the smoke and toxic effluent generation potential for each space concerned.
 - v) Identification of the potential for the spread of fire, smoke or toxic effluent from the space(s) concerned to other spaces.
- d) Determination of the required fire safety performance criteria for the vessel or the space(s) concerned addressed by the deemed-to-satisfy requirement(s). Performance criteria shall:
 - i) be based on the fire safety objectives and on the functional requirements of this section;

⁷ Refer to enabling legislation of the jurisdiction. Usually this is the relevant Authority of the jurisdiction.

- ii) provide a degree of safety not less than that achieved by using the deemed-to-satisfy requirements; and
 - iii) be quantifiable and measurable.
- e) Detailed description of the equivalent solution, including:
- i) A list of the assumptions used in the design.
 - ii) Any engineering software together with the assumptions and limitations of use.
 - iii) Any changes to fixed system design and installation standards.
 - iv) Any proposed operational restrictions or conditions.
- f) Technical justification demonstrating that the equivalent solution meets the required fire safety performance criteria.

B3.2 Evaluation of the equivalent solution

The engineering analysis required in Clause B3.1 shall be evaluated and approved by the competent organisation.

B4 DOCUMENTATION

A copy of the documentation, as approved by a competent organisation on behalf of an Authority, indicating that the alternative design and arrangements comply with this Annex shall be supplied to the Authority of a receiving jurisdiction should the vessel transfer to another jurisdiction.

NOTE: The approving Authority should communicate to the other Australian Authorities pertinent information concerning alternative design and arrangements approved by them.

B5 RE-EVALUATION DUE TO CHANGE OF CONDITIONS

If the assumptions and operational restrictions that were stipulated in the equivalent solution are changed, the engineering analysis shall be carried out under the changed conditions and shall be approved by a competent organisation on behalf of the Authority.

ANNEX C TESTING OF FIRE HOSE APPLIANCES

C1 SCOPE

This Annex specifies the procedure for testing the throw of fire hose appliance water jets. This Annex forms a normative part of this document. This Annex is referenced in Clause 4.7.2.2.

C2 APPLICATION

This Annex applies to fire hose appliances specified in Clause 4.7.

C3 REQUIRED OUTCOME

The risks from fire to persons that operate *fire appliances* must be minimised.

C4 TESTING PROCEDURE

The fire hose shall be tested in accordance with the following procedure (see also Figure 10):

- a) The test shall be conducted with only one fire pump operating.
- b) If more than one main fire pump is fitted, the pump of smallest capacity shall be used.
- c) The test shall be conducted using a hose connected to the highest hydrant on the vessel, or a hydrant that is the most remote from the pumps if that would result in a greater pressure loss.
- d) If the vessel is to have more than one jet of water operating simultaneously (Table 17), the test shall be conducted with the required number of jets running simultaneously.
- e) The nozzle of the fire hose appliance shall be located 1 m above the deck on which the hydrant is located.
- f) The nozzle of the fire hose appliance may be oriented at the most favourable angle to achieve maximum throw of the water jet.
- g) The throw of the water jet shall be measured to the point at which the jet strikes the horizontal deck surface. This surface is the baseline from which the height of the nozzle jet is measured.

C5 ACCEPTANCE CRITERIA

The test shall be deemed acceptable provided the throw of the water jet is no less than that specified in Table 17.

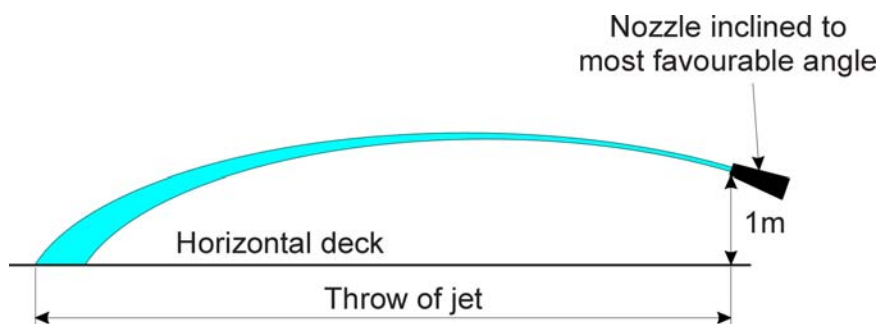

Figure 10 — Test for performance of fire hoses appliances

ANNEX D NON-COMBUSTIBLE MATERIALS

D1 SCOPE

This Annex specifies requirements for *non-combustible* materials that are alternative to the requirements contained in the FTP Code. This Annex forms a normative part of this document.

This Annex is referenced in Table 62.

D2 APPLICATION

This Annex applies to materials required to be *non-combustible* within this Section.

D3 REQUIRED OUTCOME

Materials designated as *non-combustible* must not add to the fire growth potential within a space.

D4 TESTING PROCEDURE

The material shall be tested in accordance with AS 1530 Part 1.

D5 ACCEPTANCE CRITERIA

To be accepted, the material, when heated to a temperature of 750°C—

- a) does not flame, or flames for no more than 10 seconds;
- b) exhibits a rise in surface temperature, if any, to no more than 800°C; and
- c) causes a rise in the temperature of the test furnace, if any, to no more than 800°C.

ANNEX E LOW FLAME SPREAD SURFACES

E1 SCOPE

This Annex specifies requirements for *low flame spread* surfaces that are alternative to the requirements contained in the FTP Code. This Annex forms a normative part of this document.

This Annex is referenced in Table 62.

E2 APPLICATION

This Annex applies to surfaces required to be *low flame spread* within this Section.

E3 REQUIRED OUTCOME

Surfaces designated as *low flame spread* must inhibit fire growth potential, heat production and smoke production within a space.

E4 TESTING PROCEDURE

The material shall be bonded to a substrate and tested in accordance with AS/NZS 1530 Part 3 to determine its early fire hazard properties.

E5 ACCEPTANCE CRITERIA

The material shall have early fire hazard properties in accordance with Acceptance Criteria 1 or 2 as follows:

E5.1 Acceptance criteria 1

The material shall have early fire hazard properties as follows:

- a) Spread of Flame Index shall not exceed 3.
- b) Ignitability Index plus Heat Evolved Index shall not exceed 7 (in total).
- c) Smoke Developed Index shall not exceed 4.

E5.2 Acceptance criteria 2

Alternatively, the material shall have early fire hazard properties as follows:

- a) Spread of Flame Index shall not exceed 1.
- b) Ignitability Index plus Heat Evolved Index shall not exceed 3 (in total).
- c) Smoke Developed Index shall not exceed 5.

ANNEX F CRITERIA FOR GROUP 1, GROUP 2 AND GROUP 3 EXPOSED BULKHEAD AND CEILING MATERIALS AND LININGS

F1 SCOPE

This Annex specifies criteria for Group 1, Group 2 and Group 3 *fire-restricting materials* applicable to exposed bulkhead and ceiling materials and linings. This Annex forms a normative part of this document.

This Annex is referenced in Table 62.

F2 APPLICATION

This Annex applies to materials required to be Group 1, Group 2 or Group 3 exposed bulkhead and ceiling materials and linings.

F3 REQUIRED OUTCOME

Exposed bulkhead and ceiling materials and linings designated *fire-restricting materials* must inhibit fire growth potential and smoke production within a space.

F4 DEFINITIONS

Average specific extinction area—

the average specific extinction area for smoke as determined by AS/NZS 3837.

Group 1 material—

a material that complies with the criteria listed in Clause F6.1.

Group 2 material—

a material that complies with the criteria listed in Clause F6.2.

Group 3 material—

a material that complies with the criteria listed in Clause F6.3.

Smoke growth rate index—

the index number for smoke ($SMOGR_{RC}$), predicted in accordance with Specification A2.4 using data obtained by testing of the material in accordance with ISO 9705.

F5 TESTING PROCEDURES

F5.1 Testing for groups

Tests to determine whether a wall or ceiling lining is a Group 1, Group 2 or Group 3 material shall comply with ISO 9705; or

NOTE: Groups may also be predicted in accordance with Clause 3 of BCA Specification A2.4 using data obtained by testing of the material at 50 kW/m² irradiance in accordance with AS/NZS 3837.

F5.2 Smoke growth rate index

The material shall be tested to determine the instantaneous rate of light-obscuring smoke in accordance with ISO 9705. The results of this test

shall then be used to predict the smoke growth rate index for wall and ceiling linings in accordance with Clause 4 of BCA Specification A2.4.

F5.3 Average specific extinction area

For the determination of the *average specific extinction area* for wall and ceiling linings AS/NZS 3837 at an irradiance of 50 kW/m² shall be used.

F6 ACCEPTANCE CRITERIA

F6.1 Group 1 material

Subject to Clause F6.4, and when tested in accordance with Clause F5, the material shall not reach flashover when exposed to 100 kW for 600 sec followed by exposure 300 kW for 600 sec.

F6.2 Group 2 material

Subject to Clause F6.4, and when tested in accordance with Clause F5, the material shall not reach flashover when exposed to 100 kW for 600 sec; but reaches flashover following exposure to 300 kW for less than 600 sec.

F6.3 Group 3 material

Subject to Clause F6.4, and when tested in accordance with Clause F5, the material shall not reach flashover in 120 sec or less when exposed to 100 kW, but reaches flashover in less than 600 sec when exposed to 100 kW.

F6.4 Materials in spaces not fitted with an aqueous fixed fire-extinguishing system

Group 1, Group 2, or Group 3 materials used in spaces not fitted with an aqueous *fixed fire-extinguishing system* complying with the requirements of this section, shall also have—

- a) a smoke growth rate index not more than 100; or
- b) an average specific extinction area less than 250 m²/kg.

F7 TRANSITIONAL ARRANGEMENTS

The criteria above harmonise with new provisions in the new Specification 1.10a under the BCA. Alternative criteria for Group 1, 2 and 3 *fire-restricting* materials are specified in Annex K. As a transitional arrangement, materials currently accepted under BCA Specification C1.10 will continue to be accepted until they are progressively replaced with materials accepted under BCA Specification C1.10a.

ANNEX G CRITERIA FOR LEVEL 1, LEVEL 2 AND LEVEL 3 EXPOSED FLOOR MATERIALS AND COVERINGS

G1 SCOPE

This Annex specifies criteria for Level 1, Level 2 and Level 3 *fire-restricting materials* applicable to exposed floor materials and coverings. This Annex forms a normative part of this document.

This Annex is referenced in Table 62.

G2 APPLICATION

This Annex applies to exposed floor materials and coverings required to be *fire-restricting materials* of Level 1, Level 2 or Level 3.

G3 REQUIRED OUTCOME

Exposed floor materials and coverings designated as Level 1, Level 2 or Level 3 *fire-restricting materials* must inhibit fire growth potential and smoke production within a space.

G4 DEFINITIONS

Critical radiant flux—

the critical heat flux at extinguishment as determined by ISO 9239-1.

Level 1 material—

a material that complies with the criteria listed in Clauses G6.1 and G6.4.

Level 2 material—

a material that complies with the criteria listed in Clauses G6.2 and G6.4.

Level 3 material—

a material that complies with the criteria listed in Clauses G6.3 and G6.4.

Smoke development rate—

the development rate for smoke as determined by ISO 9239-1.

G5 TESTING PROCEDURE

Tests to determine the critical radiant flux and smoke development rate of floor materials and floor coverings shall comply with ISO 9239-1.

G6 ACCEPTANCE CRITERIA

G6.1 Level 1 material

Subject to Clause G6.4, and when tested in accordance with Clause G5, the material shall have a critical radiant flux not less than 4.5.

G6.2 Level 2 material

Subject to Clause G6.4, and when tested in accordance with Clause G5, the material shall have a critical radiant flux not less than 2.4.

G6.3 Level 3 material

Subject to Clause G6.4, and when tested in accordance with Clause G5, the material shall have a critical radiant flux not less than 1.2.

G6.4 Materials in spaces not fitted with an aqueous fixed fire-extinguishing system

Level 1 or Level 2 materials used in spaces not fitted with an aqueous *fixed fire-extinguishing system* complying with the requirements of this section, shall also have a maximum smoke development rate of 750 per cent-minutes.

G7 TRANSITIONAL ARRANGEMENTS

The criteria above harmonise with new provisions in the new Specification 1.10a under the BCA. Alternative criteria for Level 1, 2 and 3 *fire-restricting* materials are specified in Annex K. This is a transitional arrangement while materials currently accepted under BCA Specification C1.10 are progressively replaced with materials under BCA Specification C1.10a.

ANNEX H CRITERIA FOR FURNITURE THAT COMPLIES WITH THE REQUIREMENTS FOR FIRE- RESTRICTING MATERIALS

H1 **SCOPE**

This Annex specifies requirements for furniture that complies with the requirements for *fire-restricting materials*. This Annex forms a normative part of this document.

This Annex is referenced in Table 62.

H2 **APPLICATION**

This Annex applies to one of the deemed-to-satisfy solutions for furniture specified in Table 62.

H3 **REQUIRED OUTCOME**

Furniture complying with this Annex must inhibit fire growth potential, heat flux, heat release and smoke production within a space.

H4 **ACCEPTANCE CRITERIA**

H4.1 **Case furniture**

All case furniture shall be constructed entirely of approved *non-combustible* or *fire-restricting materials*, except that a combustible veneer with a calorific value not exceeding 45 MJ/m² may be used on the exposed surface of such articles.

H4.2 **Chairs, sofas and tables**

All furniture such as chairs, sofas and tables shall be constructed with frames of *non-combustible* or *fire-restricting materials*.

ANNEX I CRITERIA FOR COMBUSTIBLE SOUND AND THERMAL INSULATION

I1 SCOPE

This Annex specifies criteria for the fire characteristics of combustible insulation. This Annex forms a normative part of this document.

This Annex is referenced in Clauses 3.5.2 (Table 6) and 12.10.1.

I2 APPLICATION

This Annex applies to insulation materials intended for lining spaces within a vessel for sound reduction and/or thermal insulation used for temperature control. It does not apply to insulation fitted to shield against potential fire hazard or as a barrier to personal injury.

I3 REQUIRED OUTCOME

Sound and thermal insulation fitted within a space must not materially add to the fire risk within a space.

I4 TESTING PROCEDURES

The material shall be tested in accordance with ISO 4589-3 at an ambient temperature of 60° C.

I5 ACCEPTANCE CRITERIA

The material shall have an oxygen index of at least 21.

ANNEX J PERFORMANCE OF FOAM MAKING BRANCH PIPES

J1 SCOPE

This Annex specifies requirements for *foam making branch pipes* that are designed to connect with the fire main. This Annex forms a normative part of this document.

This Annex is referenced in Clause 12.10.1.

J2 APPLICATION

This Annex applies to vessels required to be provided with *foam making branch pipes* under Clauses 6.4.15, 6.5.9 and 6.7.7

J3 DESCRIPTION

The *foam making branch pipe* shall consist of an air foam nozzle of an inductor type capable of being connected to the fire main by a fire hose, and drawing from a drum of foam concentrate.

J4 PERFORMANCE

The *foam making branch pipe* shall be capable of producing a solution rate of not less than 200 L/min and sufficient foam concentrate to operate for not less than 5 minutes. The *foam making branch pipe* shall be capable of producing finished foam with a minimum expansion ratio of 7.5:1 suitable for extinguishing a B-class fire.

NOTE: The actual minimum fire main pressure may need to be above that specified in Clause 4.7.2.1 to achieve the performance specified in this clause.

J5 SPARE CONCENTRATE

Spare drums of foam concentrate shall be carried on the vessel to supply the branch pipe for a further 5 minutes at the performance specified in Clause J4.

ANNEX K TRANSITIONAL ARRANGEMENTS FOR FIRE-RESTRICTING MATERIALS

K1 SCOPE

This Annex specifies requirements for *fire-restricting* bulkhead, ceiling and floor materials as an alternative to those specified in Annex F and Annex G. This Annex forms a normative part of this document.

This Annex is referenced in Annex F and Annex G.

K2 APPLICATION

This Annex applies as a transition arrangement while materials currently accepted under BCA Specification C1.10 are progressively replaced with materials under BCA Specification C1.10a. This Annex ceases to apply when BCA Specification C1.10 is superseded from that standard.

K3 TESTING PROCEDURE

The material shall be bonded to a substrate and tested in accordance with AS 1530 Part 3 to determine its early fire hazard properties.

K4 ACCEPTANCE CRITERIA

K4.1 **Alternative to Group 3 bulkhead and ceiling materials and linings and Level 3 exposed floor materials and coverings**

A material or component shall have a:

- a) Spread-of-Flame Index not more than 9; and
- b) Smoke Developed Index not more than 8 if the Spread-of-Flame Index is more than 5.

K4.2 **Alternative to Group 2 bulkhead and ceiling materials and linings**

A material or component shall have a:

- a) For ceilings—
 - i) Spread-of-Flame Index of not more than 6; and
 - ii) Smoke Developed Index of not more than 3.
- b) For bulkheads—
 - i) Spread-of-Flame Index of not more than 6; and
 - ii) Smoke Developed Index of not more than 5.

K4.3 **Alternative to Level 2 exposed floor materials and coverings**

A material or component shall have a:

- a) Spread-of-Flame Index of not more than 7; and
- b) Smoke Developed Index of not more than 5.

K4.4 **Alternative to Group 1 bulkhead and ceiling materials and linings and Level 1 exposed floor materials and coverings**

Apply the requirements for *low flame spread* surfaces in Annex E.